



**SPECIFICATION SHEET**

<b>SPECIFICATION SHEET NO.</b>	N0310-SOD323C15SS0WJ
<b>DATE</b>	Mar. 10, 2021
<b>REVISION</b>	A0
<b>DESCRIPTION</b>	SMD Zener Diodes, SOD-323 series, BZT52C15S Type, 2 Pads Zener Voltage 5.1 Volts Typical, Peak Pulse Power - 200 mW Operating Temp. Range -65°C ~+150°C Package in Tape/Reel, 3000pcs/Reel RoHS/RoHS III compliant
<b>CUSTOMER</b>	
<b>CUSTOMER PART NUMBER</b>	
<b>CROSS REF. PART NUMBER</b>	
<b>ORIGINAL PART NUMBER</b>	MDD BZT52C15S
<b>PART CODE</b>	SOD323C15SS0WJ

<b>VENDOR APPROVE</b>			
Issued/Checked/Approved			
DATE: March 10, 2021			

<b>CUSTOMER APPROVE</b>	
DATE:	

**SMD ZENER DIODES SOD-323 SERIES**



**MAIN FEATURE**

- Small Signal Zener Diodes
- SOD-323 Plastic-Encapsulate Diodes
- Total power dissipation: Max. 300mW.
- Planar die construction
- General purpose and medium current
- Wide Zener reverse voltage range 2.0V to 75V.
- Small plastic package suitable for surface mounted design.
- Tolerance approximately  $\pm 5\%$

**APPLICATION**

- For SMD application

**RFQ**

[Request For Quotation](#)

**PART CODE GUIDE**

SOD323	C15S	S	0WJ
1	2	3	4

1) **SOD323**: SMD Zener Diodes, SOD-323 series

2) **C15S**: Type code for original part number BZT52C15S

3) **S**: Package code, Tape/reel, 3000pcs/reel.

4) **0WJ**: Marking code for "WJ" on the case surface, Different Marking for different specification.

**SMD ZENER DIODES SOD-323 SERIES**

**MORE ITEMS AVAILABLE**

SOD3232V0SS0WY	SOD3232V2SS0WZ	SOD3232V4SS0WX		
SOD3232V7SS0WX	SOD3233V0SS0W2	SOD3233V3SS0W3	SOD3233V6SS0W4	SOD3233V9SS0W5
SOD3234V3SS0W6	SOD3234V7SS0W7	SOD3235V1SS0W8	SOD3235V6SS0W9	
SOD3236V2SS0WA	SOD3236V8SS0WB	SOD323C7V5S0WC	SOD3238V2SS0WD	SOD3239V1SS0WE
SOD323C10SS0WF	SOD323C11SS0WG	SOD323C12SS0WH	SOD323C13SS0WI	<b>SOD323C15SS0WJ</b>
SOD323C16SS0WK	SOD323C18SS0WL	SOD323C20SS0WM	SOD323C22SS0WN	SOD323C24SS0WO
SOD323C27SS0WP	SOD323C30SS0WQ	SOD323C33SS0WR	SOD323C36SS0WS	SOD323C39SS0WT
SODS23C43SS0WU	SOD323C47SS0WV	SOD323C51SS0WW	SOD323C56SS0VW	
SOD323C62SS06E	SOD323C68SS06F	SOD323C75SS06H		

**SMD ZENER DIODES SOD-323 SERIES**

**DIMENSION (Unit: Inch/mm)**

Image for reference



Marking: WJ

SOD-323

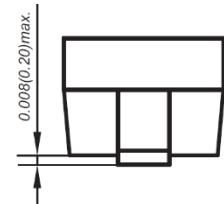
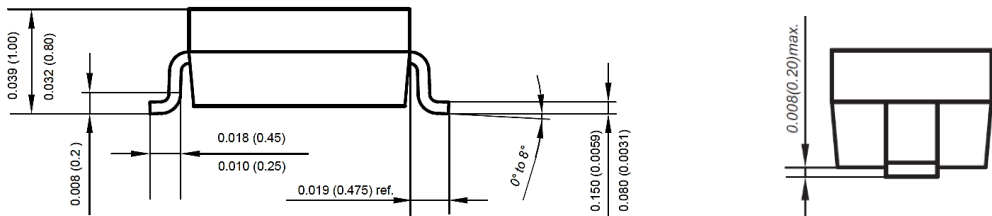
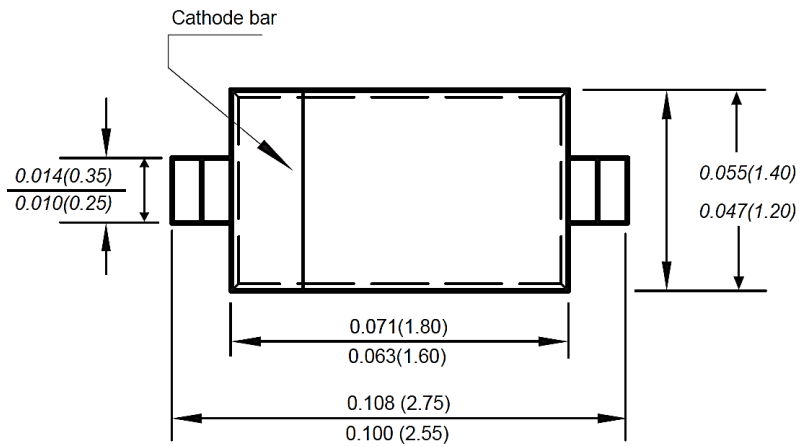

Recommend Pad Layout

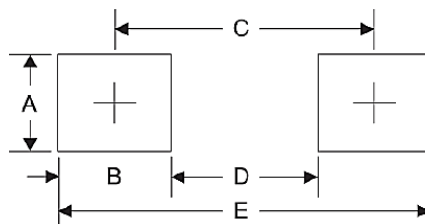

Symbol	Unit (inch)	Unit (mm)
A	0.028	0.70
B	0.028	0.70
C	0.085	2.15
D	0.071	1.80
E	0.112	2.85

**SMD ZENER DIODES SOD-323 SERIES**
**MECHANICAL DATA**

Case	Terminals	Polarity	Mounting Position	Weight per piece
JEDEC SOD-323 molded plastic body	Solder plated, Solderable per MIL-STD-750, Method 2026	Polarity symbol marking on case	Any	0.00019 Ounce, 0.0059 grams

**MAX. RATING & CHARACTERISTICS - Ratings at 25°C ambient temperature unless otherwise specified.**

Parameter	SYMBOLS	VALUE			UNITS
		Min.	Typical	Max.	
<b>Forward Voltage @ IF=10mA (Note 2)</b>	V <sub>F</sub>		0.9		V
<b>Power Dissipation (Note 1)</b>	P <sub>d</sub>		200		mW
<b>Thermal resistance junction to ambient (See Note 1)</b>	R <sub>QJA</sub>		417		°C/W
<b>junction temperature</b>	T <sub>J</sub>			+150	°C
<b>Storage temperature range</b>	T <sub>STG</sub>	-55		+150	°C

Note

1. Thermal resistance from junction to ambient at P.C.B. mounted with 2.0" X 2.0" (5 X 5 cm) copper areas pads.
2. Short duration test pulse used to minimize self-heating effect
3. f = 1 kHz

**ELECTRICAL CHARACTERISTICS - Ratings at 25°C ambient temperature unless otherwise specified.**

Parameter	SYMBOLS	VALUE			UNITS
		Min.	Typical	Max.	
<b>Zenner Voltage Range @I<sub>ZT</sub>=5.0mA (See Note 1)</b>	V <sub>ZT</sub>	13.8	15.0	15.6	V
<b>Dynamic Impedance @I<sub>ZT</sub>=5.0mA</b>	Z <sub>ZT</sub>			40	Ω
<b>Reverse Current @V<sub>R</sub>=11.0V</b>	I <sub>R</sub>			0.1	μA

Note

1. V<sub>ZT</sub> is tested with pulses (20 ms).

**SMD ZENER DIODES SOD-323 SERIES**

**RELIABILITY**

Number	Experiment Items	Experiment Method And Conditions	Reference Documents
1	Solder Resistance Test	Test 260°C± 5°C for 10 ± 2 sec. Immerse body into solder 1/16" ± 1/32"	MIL-STD-750D METHOD-2031.2
2	Solderability Test	230°C ±5°C for 5 sec.	MIL-STD-750D METHOD-2026.1 0
3	Pull Test	1 kg in axial lead direction for 10 sec.	MIL-STD-750D METHOD-2036.4
4	Bend Test	0.5Kg Weight Applied To Each Lead, Bending Arcs 90 °C ± 5 °C For 3 Times	MIL-STD-750D METHOD-2036.4
5	High Temperature Reverse Bias Test	TA=100°C for 1000 Hours at VR=80% Rated VR	MIL-STD-750D METHOD-1038.4
6	Forward Operation Life Test	TA=25°C Rated Average Rectified Current	MIL-STD-750D METHOD-1027.3
7	Intermittent Operation Life Test	On state: 5 min with rated IRMS Power Off state: 5 min with Cool Forced Air. On and off for 1000 cycles.	MIL-STD-750D METHOD-1036.3
8	Pressure Cooker Test	15 PSIG, TA=121°C, 4 hours	MIL-S-19500 APPENOIXC
9	Temperature Cycling Test	-55°C~+125°C; 30 Minutes For Dwelled Time 5 minutes for transferred time. Total: 10 cycles.	MIL-STD-750D METHOD-1051.7
10	Thermal Shock Test	0°C for 5 minutes., 100°C for 5minutes, Total: 10 cycles	MIL-STD-750D METHOD-1056.7
11	Forward Surge Test	8.3ms Single Sale Sine-wave One Surge.	MIL-STD-750D METHOD-4066.4
12	Humidity Test	TA=65°C, RH=98% for 1000 hours.	MIL-STD-750D METHOD-1021.3
13	High Temperature Storage life Test	150°C for 1000 Hours	MIL-STD-750D METHOD-1031.5

**SUGGESTED REFLOW PROFILE (For Reference Only)**

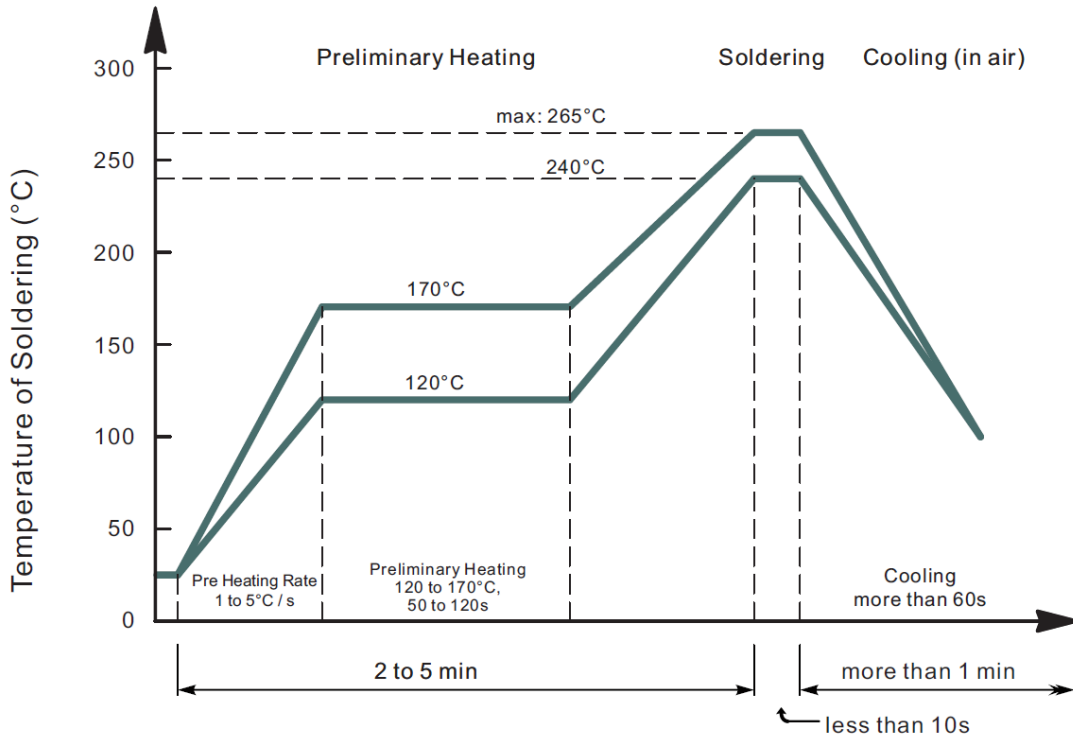

- Recommended peak temperature is over 245°C, If peak temperature is below 245 °C, you may adjust the following parameters; time length of peak temperature (longer), time length of soldering (longer), thickness of solder paste (thicker)
- Welding shall not exceed 2 times
- Remark: lead free solder paste (96.5 sn/3.0 Ag/0.5Cu)

**RATINGS AND CHARACTERISTIC CURVES (For Reference Only)**

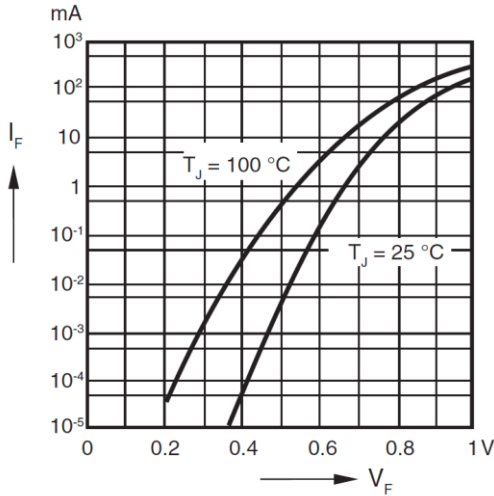

Fig. 1 - Forward characteristics

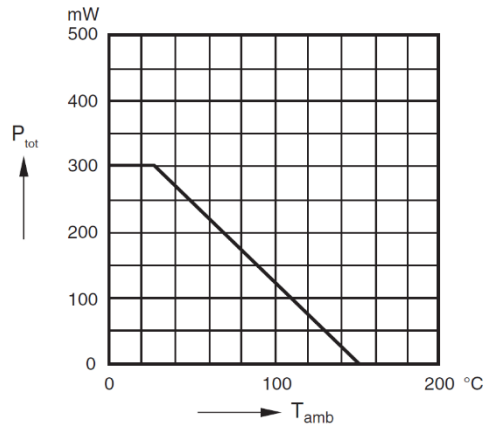

Fig. 2 - Admissible Power Dissipation vs. Ambient Temperature

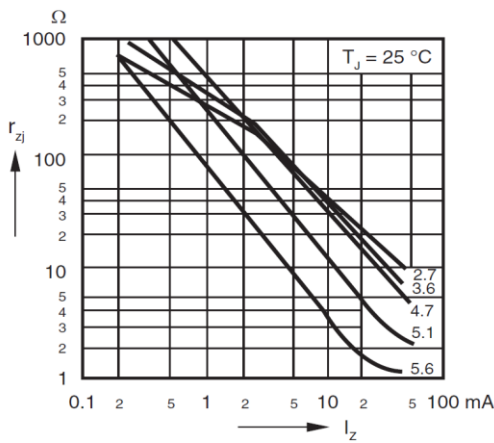

Fig. 3 - Dynamic Resistance vs. Zener Current

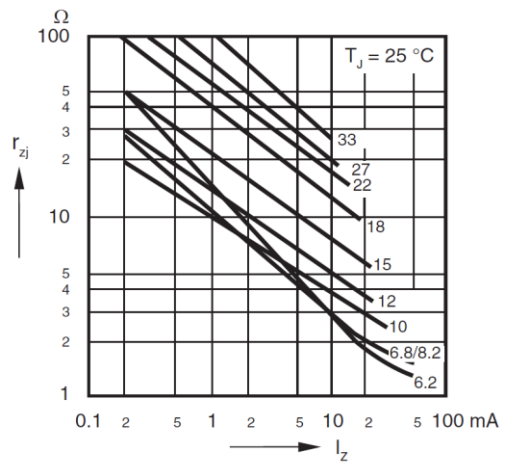

Fig. 4 - Dynamic Resistance vs. Zener Current

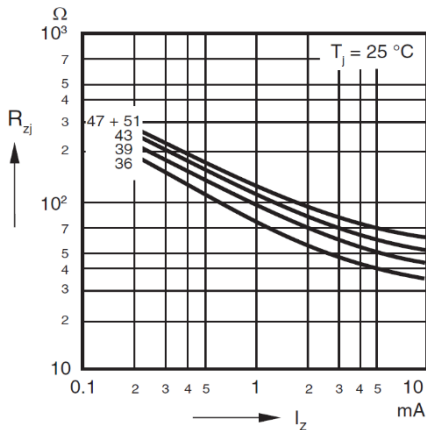

Fig. 5 - Dynamic Resistance vs. Zener Current

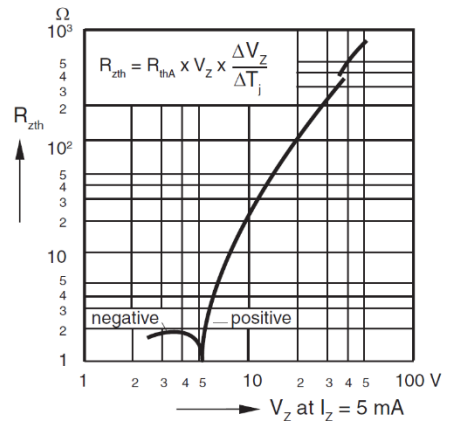

Fig. 6 - Thermal Differential Resistance vs. Zener Voltage



**RATINGS AND CHARACTERISTIC CURVES (For Reference Only)**

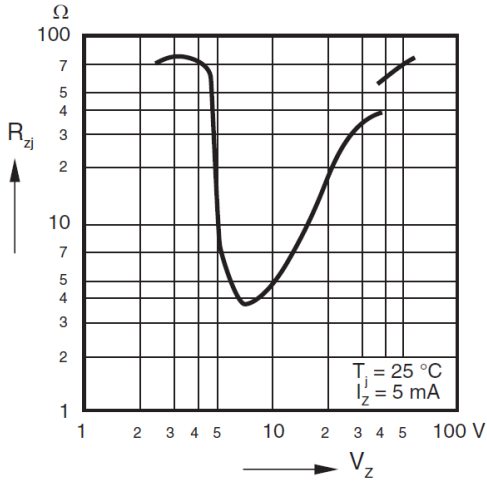

Fig. 7 - Dynamic Resistance vs. Zener Voltage

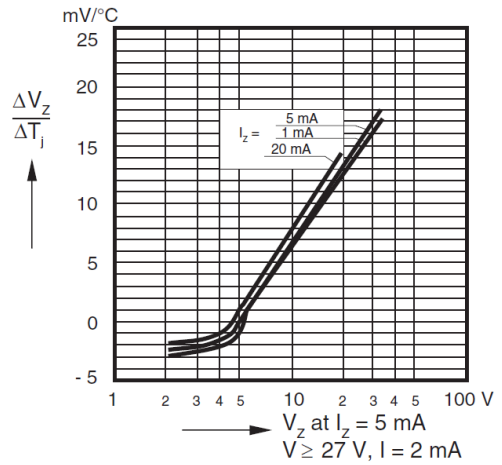

Fig. 8 - Temperature Dependence of Zener Voltage vs. Zener Voltage

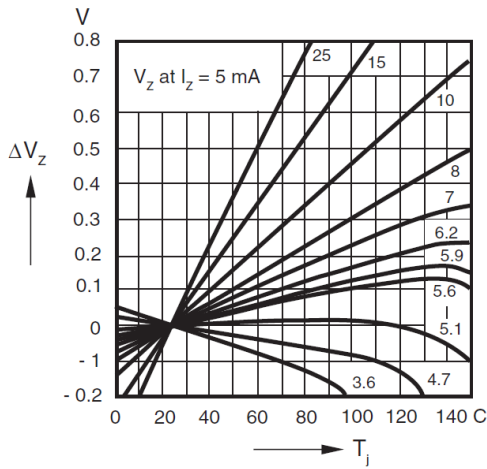

Fig. 9 - Change of Zener Voltage vs. Junction Temperature

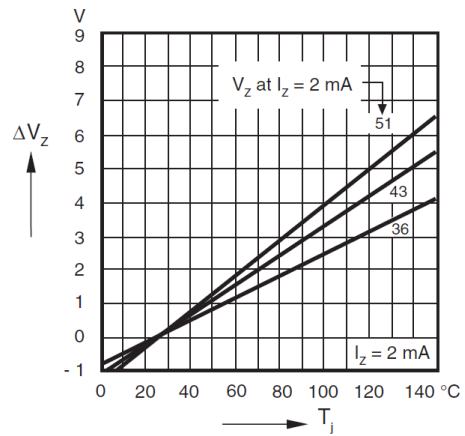

Fig. 10 - Change of Zener Voltage vs. Junction Temperature

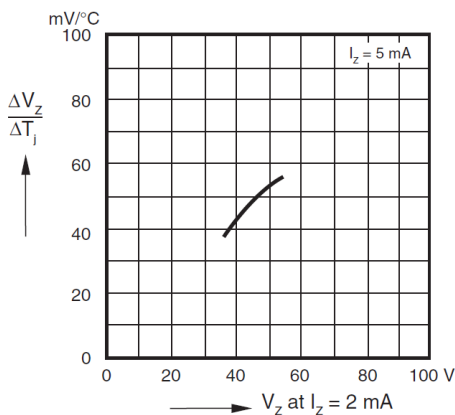

Fig. 11 - Temperature Dependence of Zener Voltage vs. Zener Voltage

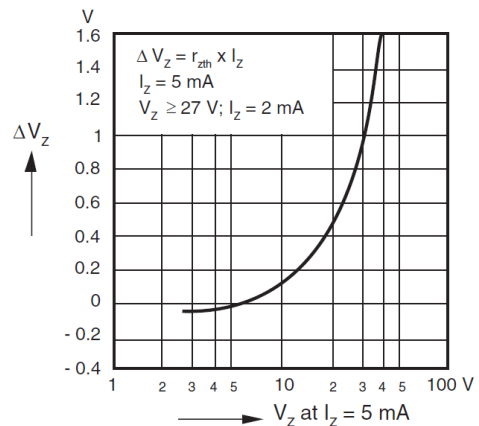

Fig. 12 - Change of Zener Voltage from Turn-on up to the Point of Thermal Equilibrium vs. Zener Voltage

**RATINGS AND CHARACTERISTIC CURVES (For Reference Only)**

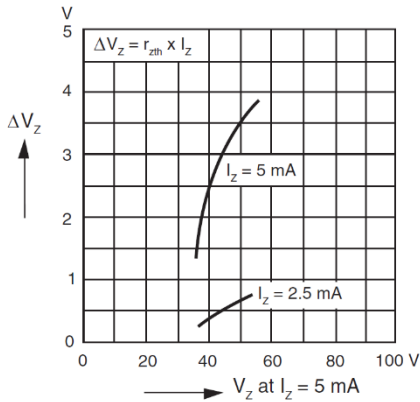

Fig. 13 - Change of Zener Voltage from Turn-on up to the Point of Thermal Equilibrium vs. Zener Voltage

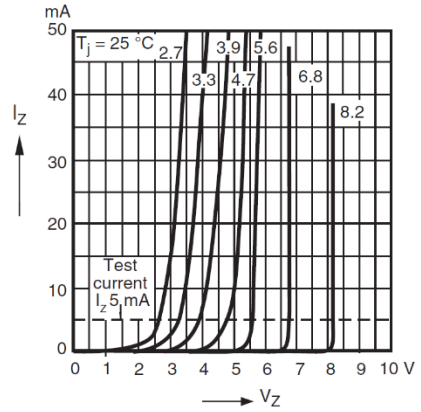

Fig. 14 - Breakdown Characteristics

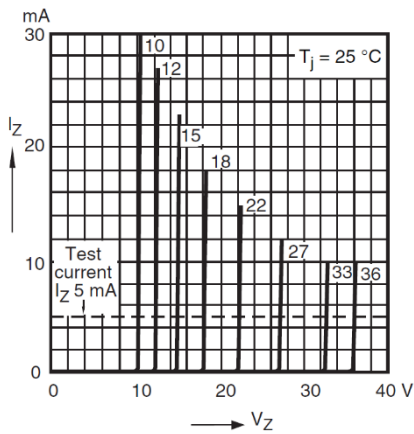

Fig. 15 - Breakdown Characteristics

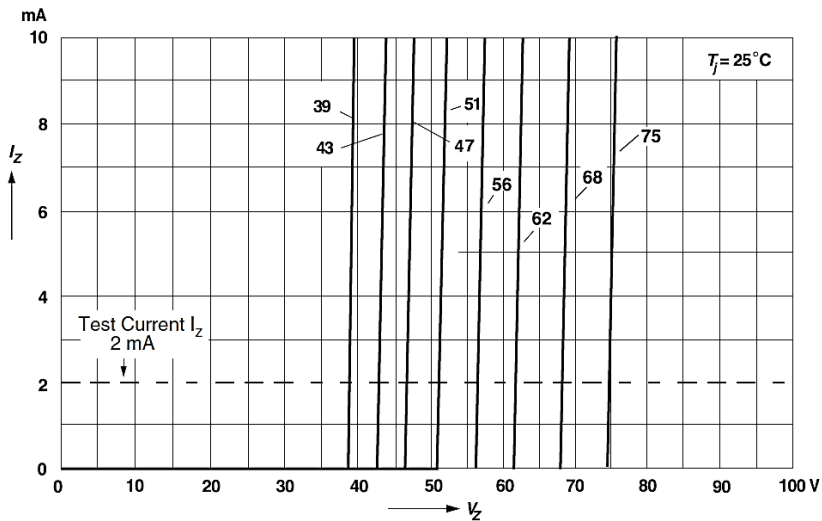
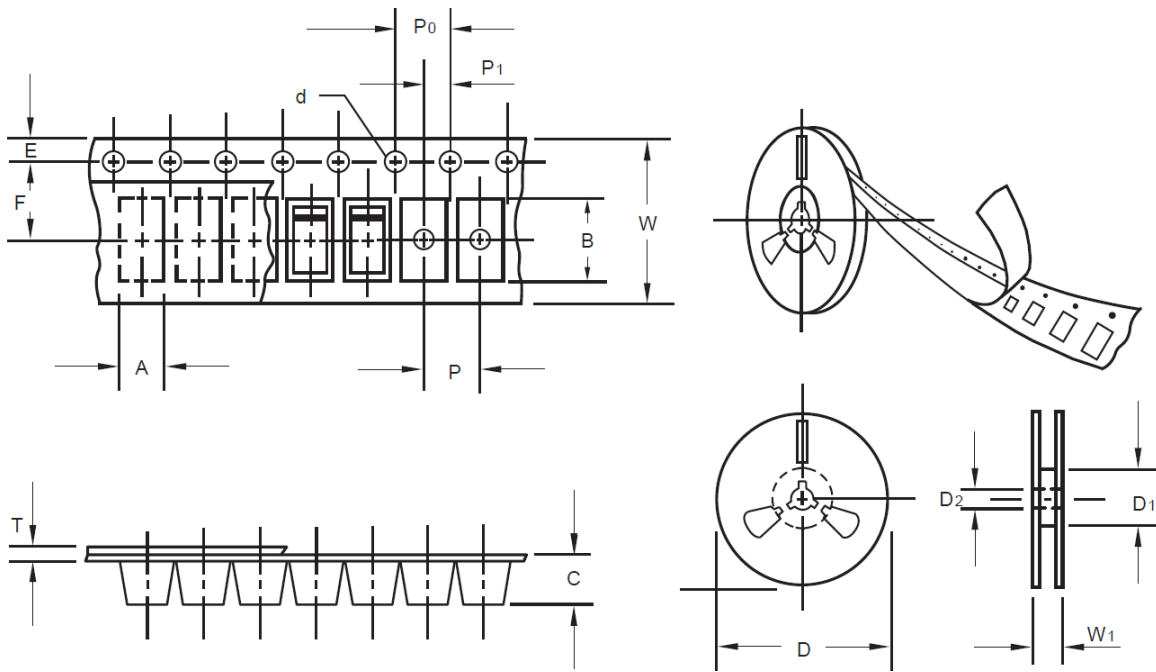

Fig. 16 - Breakdown Characteristics

**SMD ZENER DIODES SOD-323 SERIES**

**TAPE/REEL (Unit: mm)**

All Devices are packed in accordance with EIA standard RS-481-A and specifications.



Item	Symbol	Tolerance	SOD-323
Carrier width	A	0.1	2.10
Carrier Length	B	0.1	4.00
Carrier Depth	C	0.1	1.60
Sprocket hole	d	0.05	1.55
13"Reel outside diameter	-	-	-
13"Reel inner diameter	-	-	-
7"Reel outside diameter	D	2.0	178.00
7"Reel inner diameter	D1	Min.	50.00
Feed hole diameter	D2	0.5	13.00
Sprocket hole position	E	0.1	1.75
Punch hole position	F	0.1	3.50
Punch hole pitch	P	0.1	4.00
Sprocket hole pitch	P0	0.1	4.00
Embossment center	P1	0.1	2.00
Overall tape thickness	T	0.1	0.25
Tape width	W	0.3	8.15
Reel width	W1	1.0	10.50

**SMD ZENER DIODES SOD-323 SERIES**

**PACKAGE**

Case Code	Reel Size	MPQ (pcs)	Component Spacing (mm)	Qty. Per Box (pcs)	Inner Box L*W*H (mm)	Reel Size (mm)	Carton size L*W*H (mm)	Qty. Per Carton (pcs)	G. W (kg)
SOD-323	7"	3,000	-	24,000	210*208*203	178	400*400*250	180,000	8.0

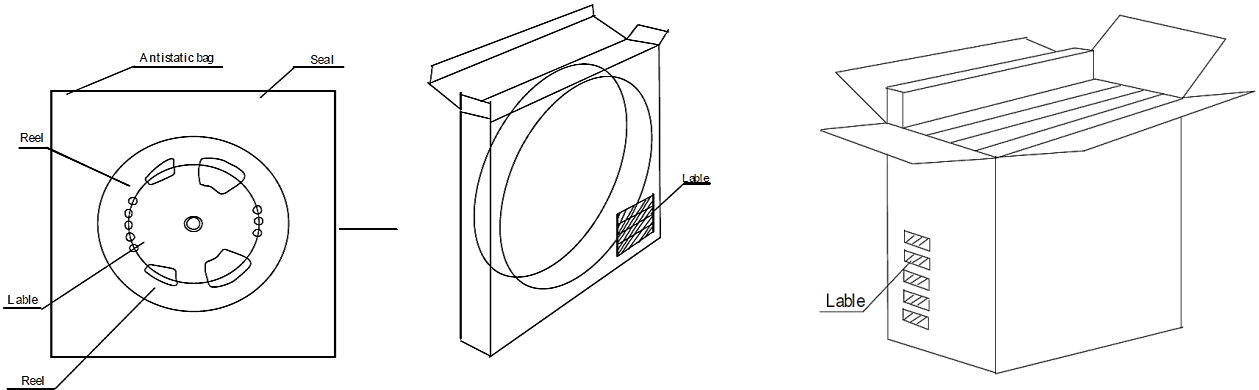

**DISCLAIMER**

NextGen Component, Inc. reserves the right to make changes to the product(s) and or information contained herein without notice. No liability is assumed as a result of their use or application. No rights under any patent accompany the sale of any such product(s) or information