



**SPECIFICATION SHEET**

|                                |                                                                                                                                                                                                                                                 |
|--------------------------------|-------------------------------------------------------------------------------------------------------------------------------------------------------------------------------------------------------------------------------------------------|
| <b>SPECIFICATION SHEET NO.</b> | N0513- CA45B010K476TA                                                                                                                                                                                                                           |
| <b>DATE</b>                    | May 13, 2021                                                                                                                                                                                                                                    |
| <b>REVISION</b>                | A0                                                                                                                                                                                                                                              |
| <b>DESCRIPTION</b>             | SMD Tantalum Capacitors CA45 Series, Case B, EIA code 3528-21<br>Rated Voltage 10 Vdc, Capacitance 47μF, Tolerance ±10%, ESR 1.5Ω Max.<br>Operating Temp. Range -55°C ~+125°C,<br>Package in Tape/Reel, 2000pcs/Reel<br>RoHS/RoHS III compliant |
| <b>CUSTOMER</b>                |                                                                                                                                                                                                                                                 |
| <b>CUSTOMER PART NUMBER</b>    |                                                                                                                                                                                                                                                 |
| <b>CROSS REF. PART NUMBER</b>  |                                                                                                                                                                                                                                                 |
| <b>ORIGINAL PART NUMBER</b>    | CA45-B010K476T                                                                                                                                                                                                                                  |
| <b>PART CODE</b>               | CA45B010K476TA                                                                                                                                                                                                                                  |

|                         |                                                                                     |                                                                                      |                                                                                       |
|-------------------------|-------------------------------------------------------------------------------------|--------------------------------------------------------------------------------------|---------------------------------------------------------------------------------------|
| <b>VENDOR APPROVE</b>   |                                                                                     |                                                                                      |                                                                                       |
| Issued/Checked/Approved |  |  |  |
| DATE: May 13, 2021      |                                                                                     |                                                                                      |                                                                                       |

|                         |  |
|-------------------------|--|
| <b>CUSTOMER APPROVE</b> |  |
|                         |  |
| DATE:                   |  |

**SMD TANTALUM CAPACITORS CA45 SERIES CASE B**

**MAIN FEATURE**

- RoHS III Compliant
- Wide Operating Temperature Range -55~+125°C
- Small volume, High Stability
- Good Frequency Characteristic

**APPLICATION**

- For Surface Mount Consumer Electronic Equipment
- Color TV sets, PC, Mobile Telephone sets Pickup camera Radar etc.

**PART CODE GUIDE**

**RFQ**  
[Request For Quotation](#)

|             |          |            |          |            |          |          |
|-------------|----------|------------|----------|------------|----------|----------|
| <b>CA45</b> | <b>B</b> | <b>010</b> | <b>K</b> | <b>476</b> | <b>T</b> | <b>A</b> |
| 1           | 2        | 3          | 4        | 5          | 6        | 7        |

- 1) **CA45**: Series code for SMD Tantalum Capacitors
- 2) **B**: Case size code for Dimension L3.50\*W2.80\*H1.90mm, EIA code 3528-21
- 3) **010**: Rated voltage Code, 010: 10 Vdc
- 4) **K**: Capacitance Tolerance code, K: +/-10%; M: +/-20%
- 5) **476**: Capacitance Code: 1<sup>st</sup> two digits represent Significant figures, 3<sup>rd</sup> Digit specifies number of Zeros. 476: 47µF
- 6) **T**: Package in Tape/Reel, 2000pcs/Reel
- 7) **A**: Internal control or Customer’s Special Code (A~Z or 1~9)

**SMD TANTALUM CAPACITORS CA45 SERIES CASE B**

**DIMENSION (Unit: mm)**



Image for reference



CA45 Case B

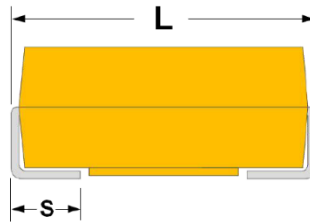

| Item | Dimension |
|------|-----------|
| L    | 3.50±0.20 |
| W1   | 2.80±0.20 |
| W2   | 2.20±0.20 |
| H    | 1.90±0.20 |
| S    | 0.70±0.20 |

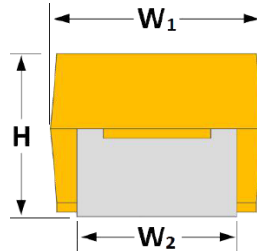

Marking: A476

Capacitance code: 47µF



Polarity: Anode (+)

Rate Voltage Code: A=10V

| Code             | F   | G | J   | A  | C  | D  | E  | V  | T  |
|------------------|-----|---|-----|----|----|----|----|----|----|
| Rate Voltage (V) | 2.5 | 4 | 6.3 | 10 | 16 | 20 | 25 | 35 | 50 |

**SMD TANTALUM CAPACITORS CA45 SERIES CASE B**

**PRODUCT STRUCTURE** Image for reference

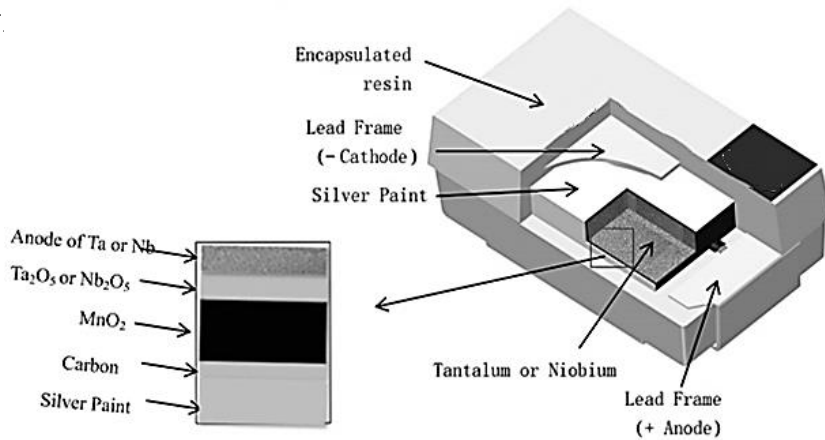

**LAND DIMENSIONS/COURTYARD**



**Density Level A:** For low-density product applications. Recommended for wave solder applications and provides a wider process window for reflow solder processes.

**Density Level B:** For products with a moderate level of component density. Provides Recommended Profile Conditions for reflow solder processes.

**Density Level C:** For high component density product applications. Before adapting the Min. land pattern variations, the user should perform qualification testing based on the conditions outlined in IPC - 7351).

**Note:**

1. Height of these chips may create problems in wave soldering.
2. Land pattern geometry is too small for silkscreen outline.

| Case Code                                    | Item                                           | Code | Dimension (mm) |
|----------------------------------------------|------------------------------------------------|------|----------------|
| B<br>(EIA 3528-21)                           | Density Level A Max. (Most) Land Protrusion    | W    | 2.35           |
|                                              |                                                | L    | 2.21           |
|                                              |                                                | S    | 0.92           |
|                                              |                                                | V1   | 6.32           |
|                                              |                                                | V2   | 4.00           |
|                                              | Density Level B Max. (Nominal) Land Protrusion | W    | 2.23           |
|                                              |                                                | L    | 1.80           |
|                                              |                                                | S    | 1.12           |
|                                              |                                                | V1   | 5.22           |
|                                              |                                                | V2   | 3.50           |
| Density Level C Max. (Least) Land Protrusion | W                                              | 2.13 |                |
|                                              | L                                              | 1.42 |                |
|                                              | S                                              | 1.28 |                |
|                                              | V1                                             | 4.36 |                |
|                                              | V2                                             | 3.24 |                |

**SMD TANTALUM CAPACITORS CA45 SERIES CASE B**

**ELECTRONICAL CHARACTERISTICS**

| Item                        | Unit | Symbol         | Characteristic                                                                                                                                                      | Condition                                                                       |
|-----------------------------|------|----------------|---------------------------------------------------------------------------------------------------------------------------------------------------------------------|---------------------------------------------------------------------------------|
| Operating Temperature Range | °C   |                | -55~+125                                                                                                                                                            | @ > 85°C<br>Applying Voltage<br>Derating: 10V                                   |
| Rated Voltage Range         | V DC |                | <b>10</b>                                                                                                                                                           |                                                                                 |
| Capacitance Tolerance       | %    |                | ±10                                                                                                                                                                 | @25°C, 100Hz                                                                    |
| Leakage Current             | µA   | I <sub>0</sub> | Measured after 5 Minutes Application of rated voltage reading, I <sub>0</sub> ≤ 0.01 C <sub>R</sub> U <sub>R</sub> or <b>4.7µA Max.</b> whichever is greater @25 °C | C <sub>R</sub> : (µF) Nominal Capacitance<br>U <sub>R</sub> : (V) Rated voltage |
| Capacitance                 | µF   | C <sub>R</sub> | <b>47</b>                                                                                                                                                           | @25°C, 100Hz                                                                    |
| Dissipation Factor          | %    | tgδ            | 8.0 Max.                                                                                                                                                            | @25°C, 100Hz                                                                    |
| ESR                         | Ω    |                | 1.5 Max.                                                                                                                                                            | @25°C, 100Hz                                                                    |

**TEMPERATURE CHARACTERISTICS**

| Item                        | Unit | Dissipation Factor (tgδ Max)                                                              |     |      | Capacitance change                |     |      | Leakage Current (I Max.)     |                   |
|-----------------------------|------|-------------------------------------------------------------------------------------------|-----|------|-----------------------------------|-----|------|------------------------------|-------------------|
| Temperature Characteristics |      | @Nominal Capacitance 47µF                                                                 |     |      |                                   |     |      |                              |                   |
|                             | °C   | -55                                                                                       | +85 | +125 | -55                               | +85 | +125 | +85                          | +125              |
|                             | %    | 9                                                                                         | 9   | 12   |                                   |     |      |                              |                   |
|                             | %    |                                                                                           |     |      | ±10                               | ±10 | ±12  |                              |                   |
|                             | µA   |                                                                                           |     |      |                                   |     |      | 8*I <sub>0</sub>             | 10*I <sub>0</sub> |
| Load Life                   |      | ≤150% of the specified value                                                              |     |      | Within ± 10% of the initial value |     |      | ≤ 8 * of the specified value |                   |
| Failure Rate Level          |      | Under the normal load of 1000 hours, the failure rate of the product is less than 100 ppm |     |      |                                   |     |      |                              |                   |

**SMD TANTALUM CAPACITORS CA45 SERIES CASE B**

**APPLICATION NTOE**

**Storage Condition**

- 1) Environmental temperature: 10°C ~ +30°C
- 2) Relative humidity no more than 60%
- 3) Storing period: No more than one and half year since the date of stocking.

**Application Guide**

**1) Ripple Current and Voltage**

If the ripple current is applied to the capacitor, the Joule heat (power dissipated) will be generated in the capacitor, so it will affect the reliability of the capacitor.

**(1) Power Dissipated**

The actual power dissipated can be calculated using the following formula:  $P=I^2 \times ESR$ .....Formula 1

P: Power dissipated (W); I: Ripple current (A); ESR: Equivalent series resistance ( $\Omega$ )

Power Dissipation for Case B ( EIA Code 3528-21): 75mW Max. @+25°C

**(2) Ripple Current**

Using the maximum power dissipation 75mW Max., the ripple current can be calculated using the following

formula:  $I= \sqrt{\frac{P}{ESR}} \times K \times F$ .....Formula 2

K: Temperature derating factor..... Table 1; F: Frequency derating factor..... Table 2

ESR: Refer to the ratings of each specific product

Table 1: Temperature Drop Factor K

| Temperature | Temperature Derating Factor K |
|-------------|-------------------------------|
| 25 °C       | 1                             |
| 85 °C       | 0.9                           |
| 125 °C      | 0.4                           |

Table 2: Frequency Derating Factor F

| Frequency (KHz) | 10   | 100 | 500  | 1000 |
|-----------------|------|-----|------|------|
| MnO2            | 0.80 | 1.0 | 1.15 | 1.20 |
| Polymer         | 0.75 | 1.0 | 1.10 | 1.30 |

Using formula 3 to calculate corrugated voltage E:  $E=Z \times I$ ..... Formula 3

E: Ripple voltage; Z: Specific frequency impedance

## SMD TANTALUM CAPACITORS CA45 SERIES CASE B

### (3) Ripple Voltage

The ripple voltage applied to the capacitor is limited by three criteria.

- (a) The power dissipation in the ESR of capacitor must not exceed 75mW Max. @+25°C
- (b) The positive peak AC voltage plus the DC bias voltage must not exceed the DC voltage rating of the capacitor.
- (c) The negative peak AC voltage, in combination with the bias voltage, if any, must not exceed the permissible reverse voltage ratings presented.

### 2) Reverse Voltage

Solid tantalum capacitors are polarized devices, and applied reverse voltage can not be allowed. If the reverse voltage is unavoidable, a small degree of transient reverse voltage is permissible for short periods as follow.

25°C..... 10% of Max. rated voltage or 1V whichever is smaller

85°C..... 5% of Max. rated voltage or 0.5V whichever is smaller

125°C.....1% of Max. rated voltage or 0.1V whichever is smaller

Even under these restrictions, capacitors can not be used continuously in reverse voltage mode.

### 3) Working Voltage

- (1) For general applications, using 50% of rated voltage of capacitors or less.
- (2) When used at the power circuit, low impedance circuit, coupling circuit or witching circuit which has leakage current problems, please design the circuit with voltage under 30% of the working voltage (max 50%) to avoid the adverse effect of the surge current.
- (3) Derating voltage when temperature above 85°C.

When the chip tantalum capacitor is used at 85°C or more temperatures, the reduced voltage ( $U_T$ ) is calculated from the following expression, however, note that the ambient temperature is not more than 125°C.

$$U_T = V_0 (U_R - U_C)(T - 85) / 40$$

$U_R$ : Rated voltage (V);  $U_C$ : Derating voltage at 125°C; T: Ambient temperature (°C)

## SMD TANTALUM CAPACITORS CA45 SERIES CASE B

### 4) Protective Resistance

In a circuit (switching circuit, charge / discharge circuit, etc.) that has an instantaneous current, series resistance is at least  $3\Omega/V$ , this can improve the reliability of tantalum capacitors. If the capacitor is in a low impedance circuit, the voltage applied to the capacitor should be half or one third of the rated voltage.

### 5) Redundancy

MnO<sub>2</sub> tantalum capacitors will heat, and may cause fire and burn in the short circuit. This is determined by the situation, time and other factors. When the circuit is designed, it is possible to provide the best possible space to keep the tantalum capacitor reliability.

### 6) Test Condition

Ambient Temperature 25°C; Relative Humidity 60 to 70%; Air Pressure 800 to 1060mbar. Test and experiment, in order to make the test results not problems, it is necessary to will test the product after fully discharge.

This product is a polar components, testing or when using it is strictly prohibited to will is negative pick back, in order to avoid performance failure

### 7) Soldering

The SMD tantalum capacitor can be used for reflow soldering, which is not suitable for wave soldering and manual welding. The reflow temperature are  $\leq 250^{\circ}\text{C}$ ,  $\leq 5$  seconds. If you must use manual welding, should use the melted solder to contact lead, and the electric soldering iron power should be less than or equal to 25W, temperature should be less than  $300^{\circ}\text{C}$ , welding time should be less than 3 seconds, can not use electric iron contact the product lead directly, and in particular, can not contact the product ontology directly. Recommended profile conditions for convection and IR reflow reflect the profile conditions of the IPC/J-STD-020D standard for moisture sensitivity testing



**SMD TANTALUM CAPACITORS CA45 SERIES CASE B**

**8) Recommended Profile Conditions**

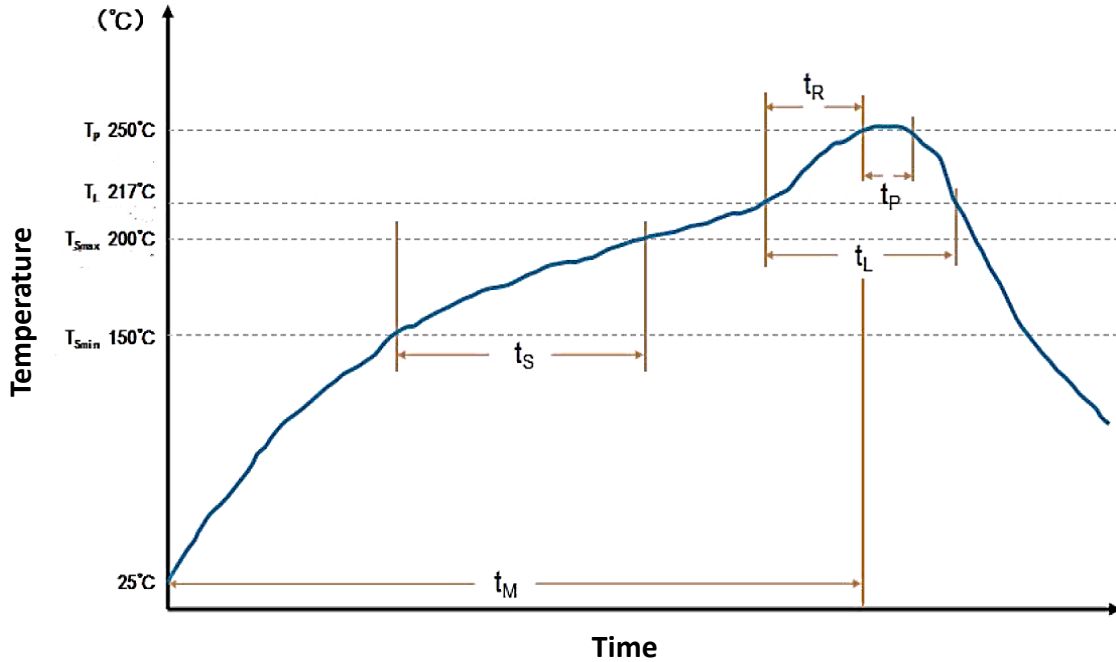

| Characteristics                       | Unit      | Symbol     | SnPb Assembly | Pb-Free Assemble |
|---------------------------------------|-----------|------------|---------------|------------------|
| Preheat Temperature Min.              | °C        | T smin     | 100           | 150              |
| Preheat Temperature Max.              | °C        | T smax     | 150           | 200              |
| Preheat time                          | Second    | T s        | 60~120        | 60~120           |
| Ramp-up Rate                          | °C/Second | T L to T p | ≤ 3           | ≤ 3              |
| Liquidous Temperature                 | °C        | T L        | 183           | 217              |
| Time Above Liquidous                  | Second    | t L        | 30~150        | 60~150           |
| Peak Temperature                      | °C        | T p        | 220 or 235    | 245 or 250       |
| Time within 5°C Max. Peak Temperature | Second    | t p        | ≤ 10          | ≤ 3              |
| Ramp-down Rate                        | °C/Second | T p to T L | ≤ 6           | ≤ 6              |
| Time 25°C to Peak Temperature         | minute    |            | ≤ 6           | ≤ 6              |

**SMD TANTALUM CAPACITORS CA45 SERIES CASE B**

**9) Recommended Voltage Derating Guidelines**

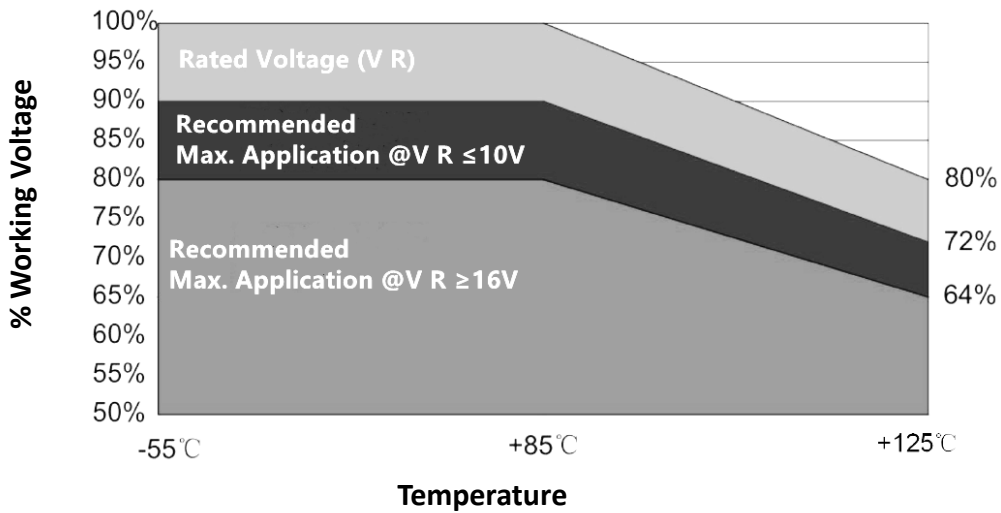

| Condition                                         | -55 °C ~ 85 °C        | -55 °C ~ 125 °C       |
|---------------------------------------------------|-----------------------|-----------------------|
| % Change in Working DC Voltage with Temperature   | V <sub>R</sub>        | 80% of V <sub>R</sub> |
| Recommended Max. Application @V <sub>R</sub> ≤10V | 90 of V <sub>R</sub>  | 72% of V <sub>R</sub> |
| Recommended Max. Application @V <sub>R</sub> ≥16V | 80% of V <sub>R</sub> | 64% V <sub>R</sub>    |

**SMD TANTALUM CAPACITORS CA45 SERIES CASE B**

**REEL 7"/180MM DIMENSION (Unit: mm, 2000pcs/Reel)**



| Code | Dimension   |
|------|-------------|
| A    | 178.0+/-2.0 |
| B    | 50.0 Min.   |
| C    | 13.0+/-0.50 |
| G    | 8.4+/-1.0   |
| T    | 1.5+/-1.0   |

**TAPE WIDE 8MM DIMENSION (Unit: mm)**

Note: Tolerance  $\pm 0.2$ mm over 10 sprocket hole spaces

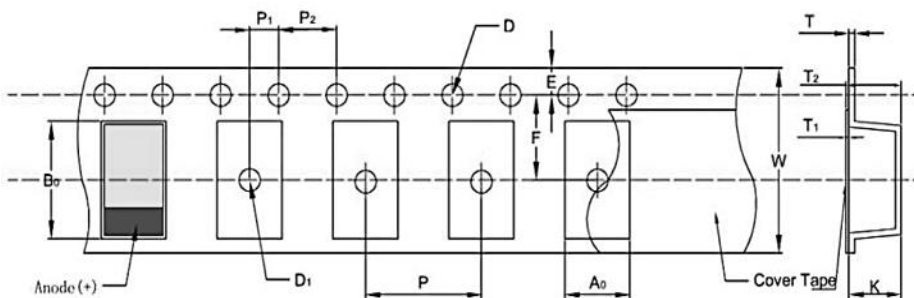

| Code | Dimension   |
|------|-------------|
| A 0  | 3.15+/-0.10 |
| B 0  | 3.77+/-0.10 |
| K    | 2.22+/-0.10 |
| W    | 8.00+/-0.30 |
| E    | 1.75+/-0.10 |
| F    | 3.50+/-0.05 |
| P    | 4.00+/-0.10 |
| P 1  | 2.00+/-0.05 |
| P 2  | 4.00+/-0.10 |
| D    | 1.50+/-0.20 |
| D 1  | 1.00+/-0.25 |

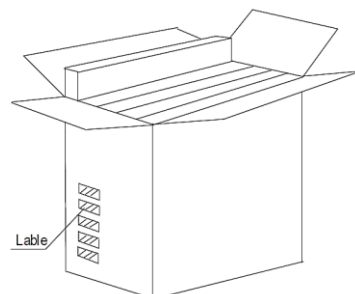
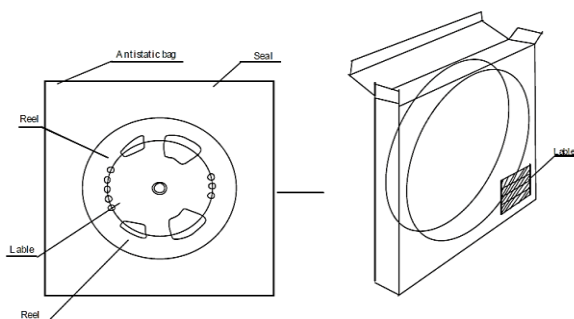

**DISCLAIMER**

NextGen Component, Inc. reserves the right to make changes to the product(s) and or information contained herein without notice. No liability is assumed as a result of their use or application. No rights under any patent accompany the sale of any such product(s) or information