



SPECIFICATION SHEET

SPECIFICATION SHEET NO.	P0530- RALLF3053A10B1
DATE	May 30, 2022
REVISION	A1
DESCRIPTION	<p>RED LED LAMPS with Flange, 3MM Round, Φ3.0*5.3mm, Viewing angle 20°</p> <p>Power dissipation, 72mW Max. DC Forward Current: 30 mA Max., Reverse Voltage. 5.0V Max.</p> <p>Operating Temp. Range -25°C ~+85°C</p> <p>Package in bulk, RoHS/RoHS III compliant</p>
CUSTOMER	
CUSTOMER PART NUMBER	
CROSS REF. PART NUMBER	
ORIGINAL PART NUMBER	TGS RALLF3053A10BLF
PART CODE	RALLF3053A10B1

VENDOR APPROVE			
Issued/Checked/Approved			
DATE: May 30, 2022			

CUSTOMER APPROVE	
DATE:	

5/30/2022

RED LED LAMPS WITH FLANGE 3050 SERIES

MAIN FEATURE

- Low power consumption
- Long life-solid state reliability
- Low Costs and Short Lead time
- RoHS III Compliant And Halogen Free Products

APPLICATION

- Display Quality Commercial, Full Spectrum Lighting

RFQ
Request For Quotation

PART CODE GUIDE

RA	LLF	3050	A	10	B	1
1	2	3	4	5	6	7

- 1) **RA**: Product code for Red LED Lamps
- 2) **LLF**: LED LAMPS with Flange
- 3) **3050**: Series Code, $\Phi 3.0 \times 5.3\text{mm}$,
- 4) **A**: Grade Code, Grade A
- 5) **10**: Reverse current code. 10: 1.0 μA Max.
- 6) **B**: Package in Bulk
- 7) **1**: Internal control code, 1~3 digits or letter; Blank: N/A

RED LED LAMPS WITH FLANGE 3050 SERIES

DIMENSION (Unit: mm)



Image for reference

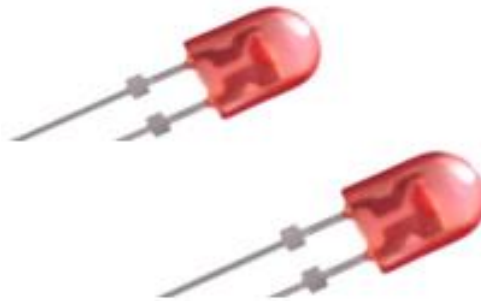

3050 Series

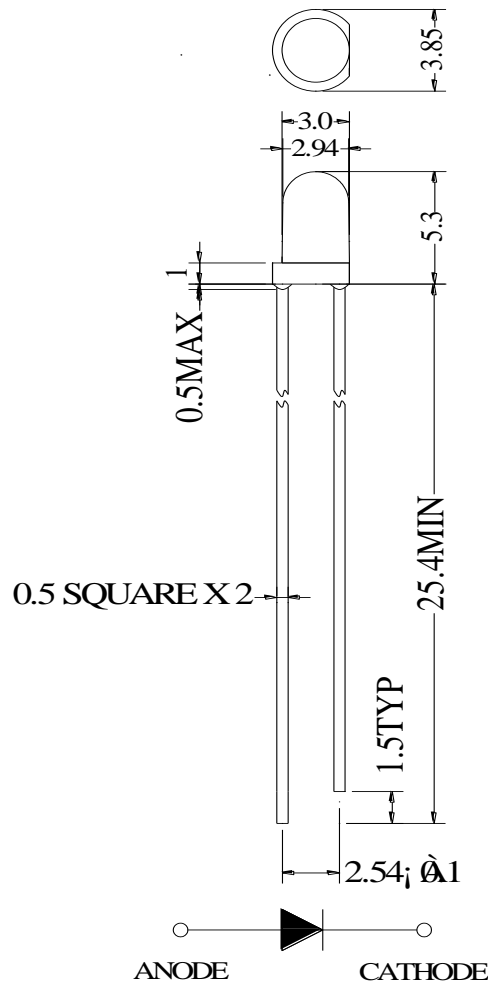

Note:

1. Tolerance is ± 0.25 unless otherwise noted;
2. Lead spacing is measured where the leads emerge from the package;
3. Specifications are subject to change without notice.

RED LED LAMPS WITH FLANGE 3050 SERIES
ELECTRICAL CHARACTERISTICS
Selection Guide

Order Part Code	Original Part No.	Emitted Color	Resin Color	Viewing Angle
RALLF3053A10B1	TGS RALLF3053A10BLF	Red	Clear	20°

Absolute Maximum Ratings at Ta=25°C

Parameter	Symbol	Value	Unit
Power dissipation	Pd	72	mW
DC Forward Current	If	30	mA
Peak Forward Current ⁽¹⁾	Ifp	100	mA
Reverse Voltage	Vr	5	V
Electro-Static-Discharge (HBM)	ESD	2000	V
Operating Temperature	Topr	-25 ~ +85	°C
Storage Temperature	Tstg	-40 ~ +100	°C
Lead Solder Temperature ⁽²⁾	Tsol	250 for 5sec	°C

Note: (1).1/10 duty cycle, 0.1 ms pulse width (2).2mm below package base.

Electrical/Optical Characteristics Ta=25°C

Parameter	Symbol	Condition	Value			Unit
			Min.	Typ.	Max.	
Forward voltage	Vf	If=20mA	---	2.0	2.4	V
Luminous intensity	Iv	If=20mA	850	1700	---	mcd
Dominant wavelength	λ_d	If=20mA	630	640	650	nm
Peak wavelength	λ_p	If=20mA	---	645	---	nm
Reverse current	Ir	Vr=5V	---	---	1	μ A

Note:

1. Forward Voltage: $\pm 0.1V$ 2. Wavelength: $\pm 1.5nm$ 3. Luminous Intensity: $\pm 10\%$

RED LED LAMPS WITH FLANGE 3050 SERIES

TYPICAL ELECTRO-OPTICAL CHARACTERISTICS CURVES

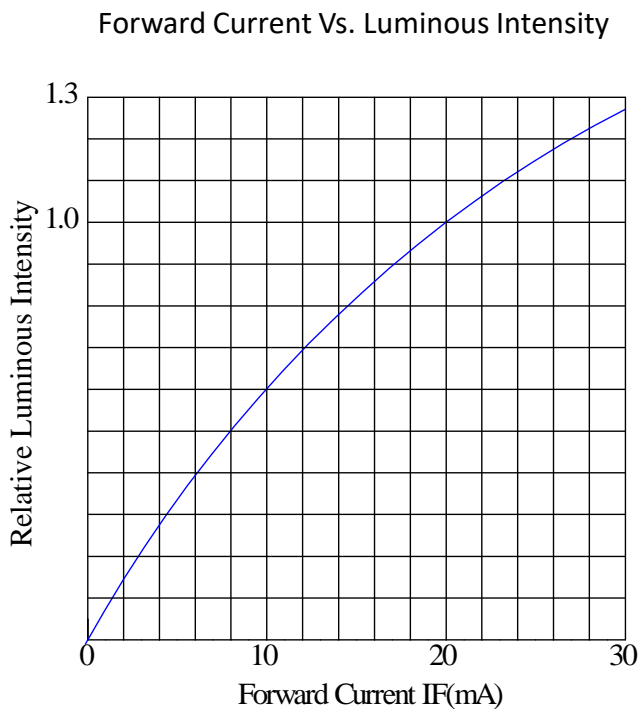
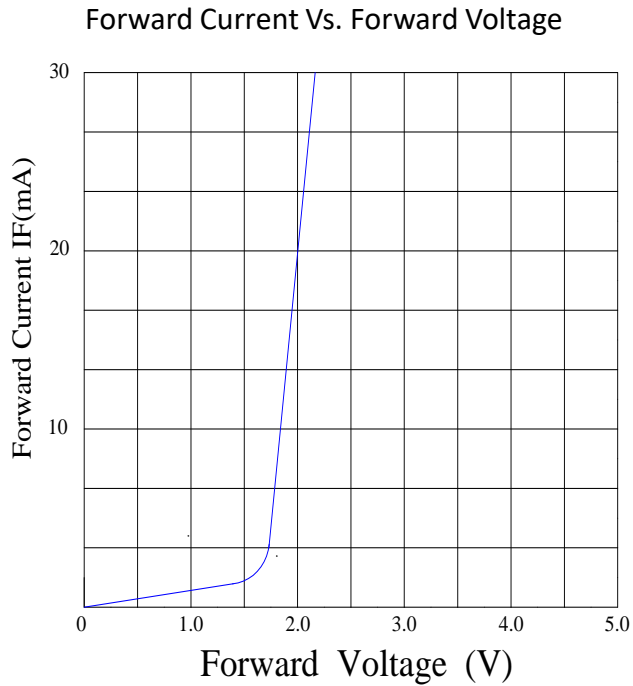

RED LED LAMPS WITH FLANGE 3050 SERIES

TYPICAL ELECTRO-OPTICAL CHARACTERISTICS CURVES

Ambient Temperature Vs. Forward Current

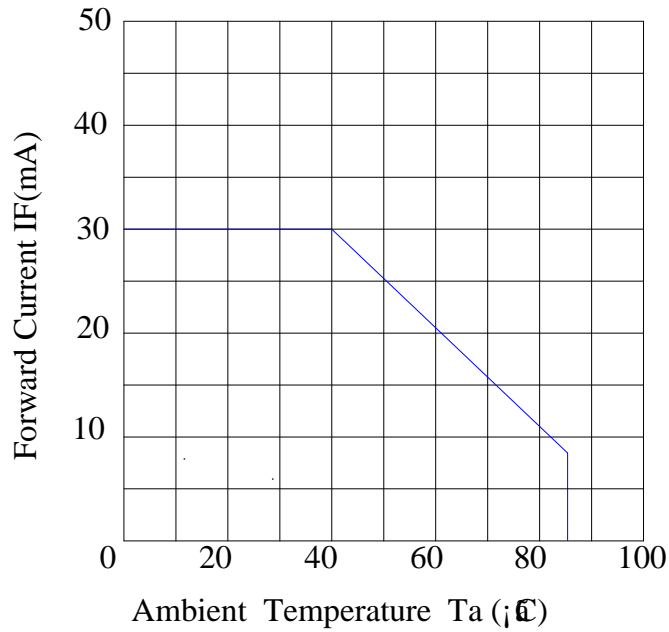

Radiation Diagram

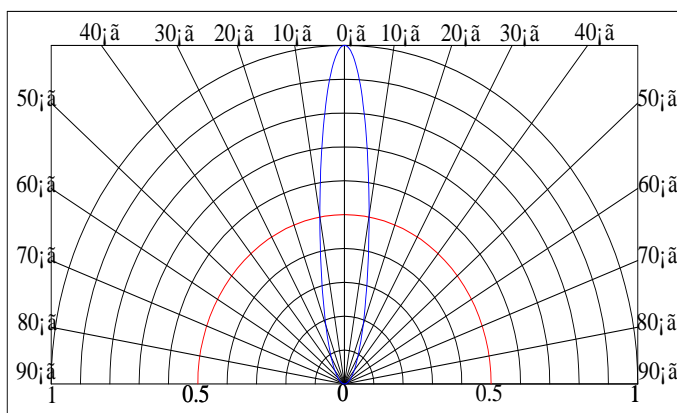

RED LED LAMPS WITH FLANGE 3050 SERIES

PRECAUTIONS

1. Storage

Under the storage conditions of 30°C or less and humidity less than 60%RH, the LEDs can be storage for 3months. Storage in a sealed container with moisture absorbent material can prolong the storage time to a certain extent bad storage conditions may cause the lead frames to corrode or degradation of LED characteristics. It is recommended that the LEDs be used as soon as possible.

2. Static electricity

Static electricity of surge voltage damages the LED .Damaged LED will show some unusual chrematistics such as the forward voltage becomes lower or the LED do not light at the low current even not light. All devices equipment and machinery must be properly grounded. At the same time, it is recommended that wrist Bands or anti-electrostatic gloves anti-electrostatic containers be used when dealing with the LED.

3. Design Consideration

When designing a circuit, the current through each LED must not exceed the absolute maximum rating specified for each LED .In the meanwhile , resistors for protection should be applied otherwise slight voltage shift will cause big current change, bum out may happen. Thermal Design is paramount important in because heat generation may result in the Characteristics decline, such as brightness decreased, Color changed and so on. Please consider the heat generation of the LED when making the system design.

4. Lead Forming

Any lead forming must be done before soldering, not during or after soldering. When forming leads ,the leads should bent at a point at least 3mm from the base of the expose bulb. Bending at the same point twice or even more should be avoided. Please use proper tools to hold and bent the leads, do not use the base of the lead frame as a fulcrum during lead forming .Bending s tress to the base of the lead frame may cause character is tics change on LED or even break it. Just for the same reason, when mounting the LED on to printed circuit board, the holes on the circuit board should be exactly aligned with the leads of the LED.

RED LED LAMPS WITH FLANGE 3050 SERIES

PRECAUTIONS

5. Soldering

Be careful because damages always caused during soldering. Please note that stress to the leads and expose bulb should be avoided during soldering particularly when heated. When soldering, leave certain distance from soldering joint to base, the distance is determined by different soldering techniques. It is recommended that soldering be performed base on the following conditions.

DIP Soldering		Hand Soldering	
Pre-Heat	100°CMax.60 sec. Max	Temperature	350°C Max
Dipping Time	250°CMax.5 sec Max	Soldering Time	3 Sec. Max
Dipping Position	2mm ,Min. From soldering joint to base	Soldering Position	2mm ,Min From soldering joint to base

DISCLAIMER

NextGen Component, Inc. reserves the right to make changes to the product(s) and or information contained herein without notice. No liability is assumed as a result of their use or application. No rights under any patent accompany the sale of any such product(s) or information