



**SPECIFICATION SHEET**

<b>SPECIFICATION SHEET NO.</b>	Q0526- CR0201FM1M2S01
<b>DATE</b>	May. 26, 2023
<b>REVISION</b>	A0
<b>DESCRIPTION</b>	Thick Film Chip Resistors, 0201 (0603 Metric), CR01 Series, Dimension L0.60*W0.30*H0.23mm, 2 Terminations Tolerance: ±1%, Resistance 1.2M ohm, Dissipation Max. 1/20W @ 70°C Temperature Coefficient Rate (TCR) Max. ±200ppm/°C Operating Temp. Range -55°C ~+125°C Package in Tape/Reel, 15,000pcs/Reel RoHS/RoHS III compliant and HF
<b>CUSTOMER</b>	
<b>CUSTOMER PART NUMBER</b>	
<b>CROSS REF. PART NUMBER</b>	
<b>ORIGINAL PART NUMBER</b>	Aillen CR01FM1M2
<b>PART CODE</b>	CR0201FM1M2S01

<b>VENDOR APPROVE</b>			
Issued/Checked/Approved			
DATE: May. 26, 2023			

<b>CUSTOMER APPROVE</b>	
DATE:	

5/26/2023

**THICK FILM CHIP RESISTORS CR01 SERIES**

**DESCRIPTION**

The resistors are constructed in a high grade ceramic body (aluminum oxide). Internal metal electrodes are added at each end and connected by a resistive paste that is applied to the top surface of the substrate. The composition of the paste is adjusted to give the approximate resistance required and the value is trimmed to within tolerance by laser cutting of this resistive layer. The resistive layer is covered with a protective coat. Finally, the two external end terminations are added. For ease of soldering the outer layer of these end terminations is a Tin (lead free) alloy.



**MAIN FEATURE**

- High Reliability And Stability
- Reduced Size Of Final Equipment
- Lower Assembly Costs
- Higher Component And Equipment Reliability
- RoHS III Compliant And Halogen Free Products

**APPLICATION**

- Consumer Electrical Equipment
- EDP, Computer Application
- Telecom Application

**RFQ**

[Request For Quotation](#)

**PART CODE GUIDE**

CR	0201	F	M	1M2	S01
1	2	3	4	5	6

- 1) **CR**: Product code for Thick Film Chip Resistors
- 2) **0201**: Size Code, 0201 (0603 Metric), CR01 Series, Dimensions L0.60\*W0.30\*H0.23mm,
- 3) **F**: Resistance Range Tolerance Code, P: Jumper; B: +/-0.1%; D: +/-0.5%; F: +/-1%; J: +/-5%
- 4) **M**: Package Code, A: 4Kpcs/7"Reel; B:5kpcs/7"Reel; C:10kpcs/7"Reel; M:15kpcs/7"Reel; D:10kpcs/10"Reel; E:20kpcs/10"Reel
- 5) **1M2**: Resistance value code. 0R: 0ohm; 1R2: 1.2ohm; 10R: 10ohm; 20R: 20ohm; 51R: 51ohm; 160R: 160ohm; 390R: 390ohm  
1K: 1Kohm; 1K3: 1.3Kohm; 10K: 10Kohm; 18K: 18Kohm; 100K: 100Kohm; 124K: 124Kohm; 1M: 1.0Mohm; 1M2: 1.2Mohm
- 6) **S01**: Internal control code, digits and letter; Blank: N/A

**THICK FILM CHIP RESISTORS CR01 SERIES**

**DIMENSION (Unit: mm)**

Image for reference



**General Marking:**  
Blank

CR01 series



Item	Dimension
L	0.60±0.03
W	0.30±0.03
T	0.23±0.03
T b	0.15±0.05
T t	0.10±0.05

**Resistors Construction For Reference**

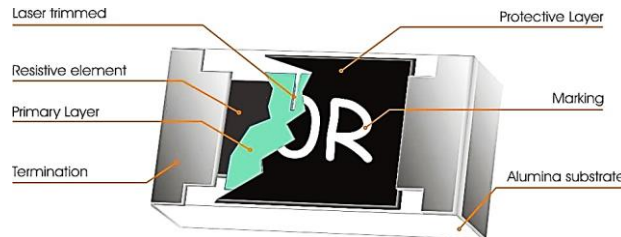

**Recommended Solder Pad**

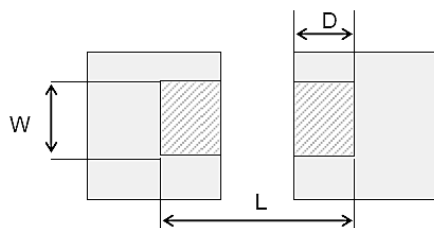

Item	Dimension (mm)
W	0.25~0.30
L	0.70~0.90
D	0.30~0.40

**THICK FILM CHIP RESISTORS CR01 SERIES**
**GENERAL ELECTRONICAL CHARACTERISTICS**

Item	Unit	Symbol	Characteristic	Condition
<b>Product Name</b>		CR	Thick Film Chip Resistors	
<b>Size</b>		0201	CR01 Series, L0.60*W0.30*H0.23mm	
<b>Resistance Range</b>	Ω		1.2M	
<b>Resistance Tolerance</b>	%	F	+/-1	
<b>TCR</b>	<b>10Ω~10MΩ</b>	ppm/°C	≤±200	
	<b>1Ω~9.76Ω</b>		-200~+600	
<b>Max. Dissipation</b>	W		1/20	@ Tamb=70°C
<b>Operating Temperature</b>	°C		-55 ~+125	
<b>Max. Operation Voltage</b>	V		25	@DC or RMS
<b>Max. Overload Voltage</b>	V		50	@DC or RMS

**Note**

- 1) This is the maximum voltage that may be continuously supplied to the resistor element, see "IEC publication 60115-8"
- 2) Max. Operation Voltage : So called RCWV (Rated Continuous Working Voltage) is determined by  

$$RCWV = \sqrt{\text{Rated Power} \times \text{Resistance Value}}$$
or Max. RCWV listed above, whichever is lower.
- 3) Test condition for jumper (0 Ω)

Item	Unit	Symbol	Characteristic	Condition
<b>Power Rating At 70°C</b>	W		1/20	
<b>Max. Resistance</b>	mΩ		50	
<b>Rated Current</b>	A		1.0	
<b>Peak Current</b>	A		2.5	
<b>Operating Temperature</b>	°C		-55 ~+125	

## THICK FILM CHIP RESISTORS CR01 SERIES

### PRODUCT CHARACTERIZATION

Standard values of nominal resistance are taken from the E24 & E96 series for resistors with a tolerance of +/-1% & +/-5%. The values of the E24/E96 series are in accordance with "IEC publication 60063"

### DERATING

The power that the resistor can dissipate depends on the operating temperature; see Fig.1

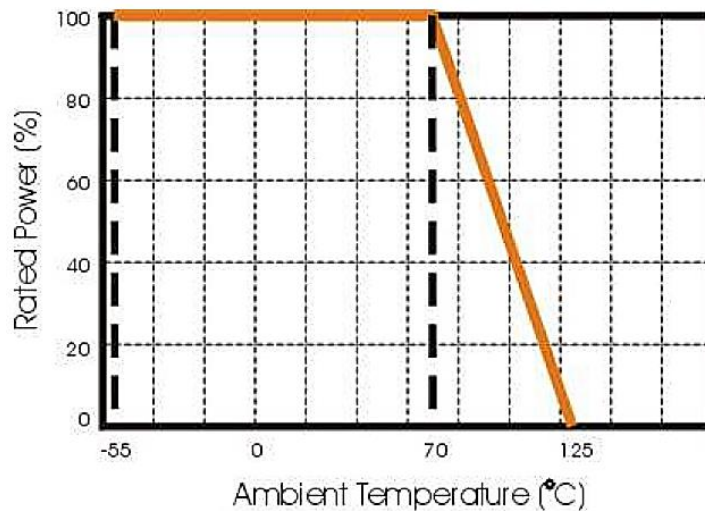

Fig 1 Maximum dissipation in percentage of rated power as a function of the ambient temperature for CR0402

### MOUNTING

Due to their rectangular shapes and small tolerances, Surface Mountable Resistors are suitable for handling by automatic placement systems. Chip placement can be on ceramic substrates and printed-circuit boards (PCBs). Electrical connection to the circuit is by individual soldering condition. The end terminations guarantee a reliable contact.

**THICK FILM CHIP RESISTORS CR01 SERIES**

**REFLOW SOLDERING CONDITION**

The robust construction of chip resistors allows them to be completely immersed in a solder bath of 260 °C for 10 seconds. Therefore, it is possible to mount Surface Mount Resistors on one side of a PCB and other discrete components on the reverse (mixed PCBs). Surface Mount Resistors are tested for solderability at 235 °C during 2 seconds. The test condition for no leaching is 260°C for 30 seconds. Typical examples of soldering processes that provide reliable joints without any damage are given in Fig 2.



Fig 2. Infrared soldering profile for Chip Resistors

**THICK FILM CHIP RESISTORS CR01 SERIES**
**TEST AND REQUIREMENT (JIS C 5201-1 : 1998)**

TEST	PROCEDURE / TEST METHOD	REQUIREMENT	
		Resistor	0Ω
<b>Electrical Characteristics</b> <b>JIS C 5201-1: 1998</b> <b>Clause 4.8</b>	- DC resistance values measurement - Temperature Coefficient of Resistance (T.C.R) Natural resistance change per change in degree centigrade. $\frac{R_2 - R_1}{R_1(t_2 - t_1)} \times 10^6 \text{ (ppm/}^\circ\text{C)}$ t1 : 20°C+5°C-1°C; t2 : -55°C or +125°C R1 : Resistance at reference temperature (20°C+5°C/- 1°C) R2: Resistance at test temperature (-55°C or +125°C)	Within the specified tolerance Refer to “QUICK REFERENCE DATA”	<50mΩ
<b>Short time overload (S.T.O.L) Clause 4.13</b>	Permanent resistance change after a 5second application of a voltage 2.5 times RCWV or the maximum overload voltage specified in the above list, whichever is less.	ΔR/R max. ±(2%+0.10Ω)	<50mΩ
<b>Resistance to soldering heat(R.S.H) Clause 4.18</b>	Un-mounted chips completely immersed for 10±1second in a SAC solder bath at 260°C±5°C	ΔR/R max. ± (1%+0.05Ω) no visible damage	<50mΩ
<b>Solderability Clause 4.17</b>	Un-mounted chips completely immersed for 2±0.8 second in a SAC solder bath at 235°C±5°C	95% coverage min., good tinning and no visible damage	
<b>Temperature cycling Clause 4.19</b>	30 minutes at -55°C±3°C, 2~3 minutes at 20°C+5°C-1°C, 30 minutes at +125°C±3°C, 2~3 minutes at 20°C+5°C1°C, total 5 continuous cycles	ΔR/R max. ±(1%+0.05Ω)	<50mΩ
<b>Damp Heat (Load life in humidity) Clause 4.24</b>	1000 +48/-0 hours, loaded with RCWV or Vmax in humidity chamber controller at 40°C±2°C and 90~95% relative humidity, 1.5hours on and 0.5 hours off	10Ω≤R<1MΩ : ΔR/R max. ±(3%+0.10Ω) R<10Ω, R≥1MΩ : ΔR/R max. ±(5%+0.10Ω)	<50mΩ

**THICK FILM CHIP RESISTORS CR01 SERIES**

**TEST AND REQUIREMENT (JIS C 5201-1 : 1998)**

TEST	PROCEDURE / TEST METHOD	REQUIREMENT	
		Resistor	0Ω
<b>Load Life (Endurance)</b> <b>Clause 4.25</b>	1000+48/-0 hours; loaded with RCWV or V max in chamber controller 70±2°C, 1.5 hours on and 0.5 hours off	Ditto.	
<b>Bending strength</b> <b>Clause 4.33</b>	Resistors mounted on a 90mm glass epoxy resin PCB(FR4), bending once 5mm for 10sec	No visual damaged, ΔR/R max. ±(1%+0.05Ω)	<50mΩ
<b>Adhesion</b> <b>Clause 4.32</b>	Pressurizing force: 3N, Test time: 10±1sec.	No remarkable damage or removal of the terminations	

**STORAGE AND HANDLING CONDITIONS**

- 1) Products are recommended to be used up within two years since operation date as ensured shelf life. Check solderability in case shelf life extension is needed.
- 2) To store products with following condition: Temperature : 5 to 40°C Humidity: 20 to 70% relative humidity
- 3) Don't store products in a corrosive environment such as sulfide, chloride gas, or acid. It may cause oxidization of electrode, which easily be resulted in poor soldering b.To store products on the shelf and avoid exposure to moisture. Don't expose products to excessive shock, vibration, direct sunlight and so on.



**THICK FILM CHIP RESISTORS CR01 SERIES**

**REEL DIMENSION (Unit: mm)**

7": 15,000Ppcs/Reel



Code	Dimension 7"	Dimension 10"	Dimension 13"
A	178.0+/-2.0	254.0+/-2.0	330.0+/-2.0
B	60.0 +/-1.0	100 +/-1.0	100+/-1.0
C	13.0+/-0.20	13.0+/-0.20	13.0+/-0.20
T	9.0+/-0.50	9.0+/-0.5	9.0+/-0.5

**TAPE DIMENSION (Unit: mm)**

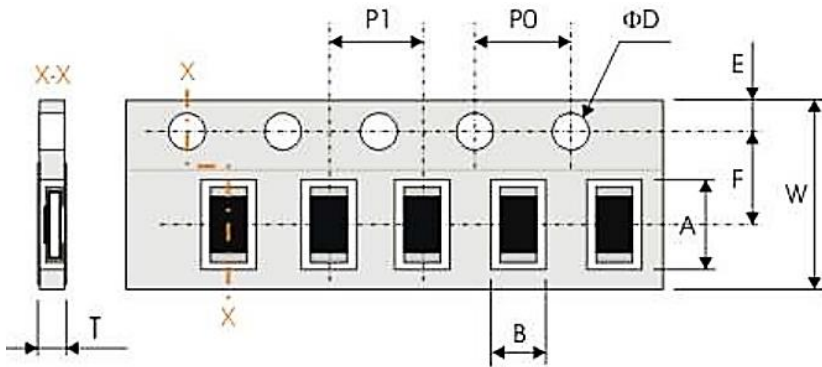

Code	Dimension
A	0.67±0.05
B	0.37±0.05
W	8.00±0.20
F	3.50±0.05
E	1.75±0.10
P 1	2.00±0.05
P0	4.00±0.05
ΦD	1.50±0.10
T	0.45±0.05

**TAPING QUANTITY AND TAPE MATERIAL**

Tape	Paper Tape						Embossed Tape	Bulk Cassette
	4 mm Pitch			2 mm Pitch			4 mm Pitch	
Reel Size	7"	10"	13"	7"	10"	13"	7"	
CR01	-	-	-	15000pcs	-	-	-	-

## THICK FILM CHIP RESISTORS CR01 SERIES

### PERFORMANCE OF TAPING

#### Strength of Carrier Tape and Top Cover Tape

Carrier Tape: When a tensile force 1.02kgf is applied in the direction of unreeling the tape, the tape shall withstand this force. Top cover Tape: When a tensile force 1.02kgf is applied to the tape, the tape shall withstand this force.

#### Peel Force of Top Cover Tape

Unless otherwise specified, the peel force of top cover tape shall be 10.2 to 71.4 g f when the top cover tape is pulled at a speed of 300mm/min with the angle between the taped during peel and the direction of unreeling maintained at 165 to 180° as illustrated in Fig.



### DISCLAIMER

NextGen Component, Inc. reserves the right to make changes to the product(s) and or information contained herein without notice. No liability is assumed as a result of their use or application. No rights under any patent accompany the sale of any such product(s) or information