



SPECIFICATION SHEET

| | |
|--------------------------------|---|
| SPECIFICATION SHEET NO. | Q0605- CR1206JB330RS1 |
| DATE | June. 5, 2023 |
| REVISION | A0 |
| DESCRIPTION | Thick Film Chip Resistors, 1206(3216 Metric), CR06 Series, Dimension L3.10*W1.60*H0.60mm, 2 Terminations Tolerance: ±5%, Resistance 330 ohm, Dissipation Max. 1/4W @ 70°C Temperature Coefficient Rate (TCR) Max. ±100ppm/°C Operating Temp. Range -55°C ~+155°C Package in Tape/Reel, 5,000pcs/Reel RoHS/RoHS III compliant and HF |
| CUSTOMER | |
| CUSTOMER PART NUMBER | |
| CROSS REF. PART NUMBER | |
| ORIGINAL PART NUMBER | Aillen CR06JB330R |
| PART CODE | CR1206JB330RS1 |

| | | | |
|-------------------------|---|--|---|
| VENDOR APPROVE | | | |
| Issued/Checked/Approved |  |  |  |
| DATE: June. 5, 2023 | | | |

| | |
|-------------------------|--|
| CUSTOMER APPROVE | |
| | |
| DATE: | |

6/5/2023

THICK FILM CHIP RESISTORS CR06 SERIES

DESCRIPTION

The resistors are constructed in a high grade ceramic body (aluminum oxide). Internal metal electrodes are added at each end and connected by a resistive paste that is applied to the top surface of the substrate. The composition of the paste is adjusted to give the approximate resistance required and the value is trimmed to within tolerance by laser cutting of this resistive layer. The resistive layer is covered with a protective coat. Finally, the two external end terminations are added. For ease of soldering the outer layer of these end terminations is a Tin (lead free) alloy.



MAIN FEATURE

- High Reliability And Stability
- Reduced Size Of Final Equipment
- Lower Assembly Costs
- Higher Component And Equipment Reliability
- RoHS III Compliant And Halogen Free Products

APPLICATION

- Consumer Electrical Equipment
- EDP, Computer Application
- Telecom Application

RFQ

[Request For Quotation](#)

PART CODE GUIDE

| CR | 1206 | J | B | 330R | S1 |
|----|------|---|---|------|----|
| 1 | 2 | 3 | 4 | 5 | 6 |

- 1) **CR**: Product code for Thick Film Chip Resistors
- 2) **1206**: Size Code, 1206(3216 Metric), CR06 series, Dimension L3.10*W1.60*H0.60mm
- 3) **J**: Resistance Range Tolerance Code, P: Jumper; B: +/-0.1%; D: +/-0.5%; F: +/-1%; J: +/-5%
- 4) **B**: Package Code, A: 4Kpcs/7"Reel; B:5kpcs/7"Reel; C:10kpcs/7"Reel; M:15kpcs/7"Reel; D:10kpcs/10"Reel; E:20kpcs/10"Reel
- 5) **330R**: Resistance value code. 0R: 0ohm; 1R2: 1.2ohm; 12R: 12ohm; 20R: 20ohm; 51R: 51ohm; 240R: 240ohm; 330R: 330ohm
1K:1Kohm; 2K: 2Kohm; 3K9: 3.9Kohm; 15K: 15 Kohm;10K5: 10.5Kohm; 1K21: 1.21Kohm; 100K: 100Kohm; 240K: 240Kohm; 1M: 1.0Mohm; 2M: 2Mohm
- 6) **S1**: Internal control code, digits and letter; Blank: N/A

THICK FILM CHIP RESISTORS CR06 SERIES

DIMENSION (Unit: mm)

Image for reference



General Marking:

The nominal resistance shall be marked in 3 digits or 4 digits and marked on over coat side.

CR06 series

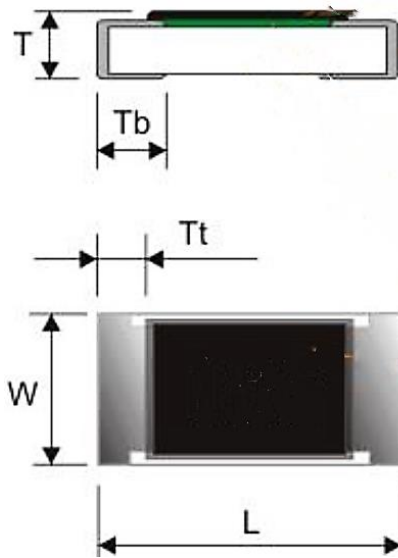

| Item | Dimension |
|------|-----------|
| L | 3.10±0.10 |
| W | 1.60±0.10 |
| T | 0.60±0.15 |
| T b | 0.45±0.20 |
| T t | 0.50±0.20 |

Resistors Construction For Reference

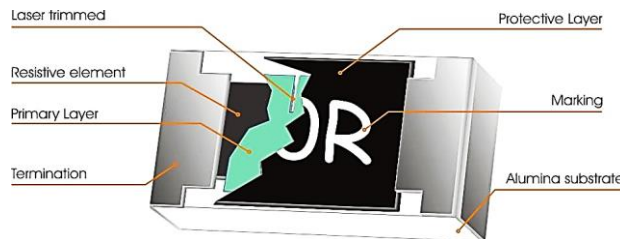

Recommended Solder Pad

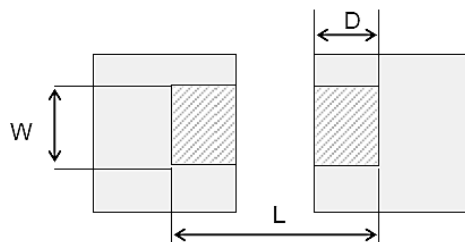

| Item | Dimension |
|------|-----------|
| W | 2.00~2.40 |
| L | 4.40~5.00 |
| D | 1.20~1.80 |

THICK FILM CHIP RESISTORS CR06 SERIES
GENERAL ELECTRONICAL CHARACTERISTICS

| Item | Unit | Symbol | Characteristic | Condition |
|-------------------------------|---------------------------|--------|-------------------------------------|-------------|
| Product Name | | CR | Thick Film Chip Resistors | |
| Size | | 1206 | CR06 Series, L3.10*W1.60*H0.60mm | |
| Resistance Range | Ω | | 330 | |
| Resistance Tolerance | % | J | ±5.0 | |
| TCR | 10MΩ≥ R>10Ω | ppm/°C | ≤ ±100 | |
| | R≤10Ω | | -200~+400 | |
| Max. Dissipation | W | | 1/4 | @ Tamb=70°C |
| Operating Temperature | °C | | -55 ~+155 | |
| Max. Operation Voltage | V | | 200 | @DC or RMS |
| Max. Overload Voltage | V | | 400 | @DC or RMS |

Note

- 1) This is the maximum voltage that may be continuously supplied to the resistor element, see “IEC publication 60115-8”
- 2) Max. Operation Voltage : So called RCWV (Rated Continuous Working Voltage) is determined by

$$RCWV = \sqrt{\text{Rated Power} \times \text{Resistance Value}}$$
or Max. RCWV listed above, whichever is lower.
- 3) Test condition for jumper (0 Ω)

| Item | Unit | Symbol | Characteristic | Condition |
|------------------------------|------|--------|----------------|-----------|
| Power Rating At 70°C | W | | 1/4 | |
| Max. Resistance | mΩ | | 50 | |
| Rated Current | A | | 2.0 | |
| Peak Current | A | | 5.0 | |
| Operating Temperature | °C | | -55 ~+155 | |

THICK FILM CHIP RESISTORS CR06 SERIES

PRODUCT CHARACTERIZATION

Standard values of nominal resistance are taken from the E24 & E96 series for resistors with a tolerance of $\pm 0.1\%$, $\pm 0.5\%$, $\pm 1\%$ & $\pm 5\%$. The values of the E24/E96 series are in accordance with "IEC publication 60063"

DERATING

The power that the resistor can dissipate depends on the operating temperature; see Fig.1

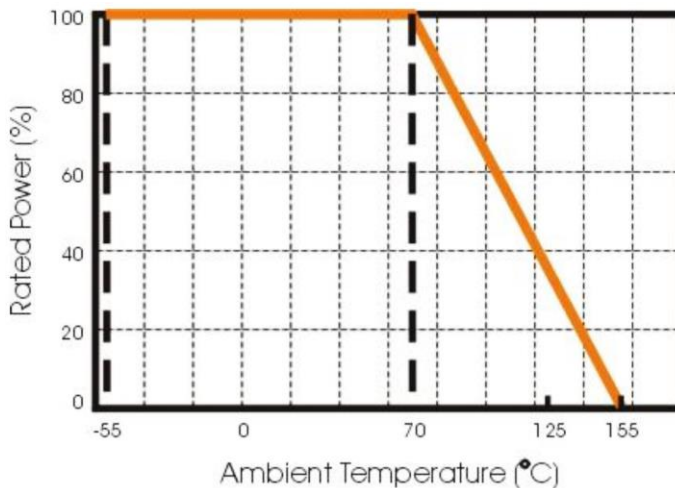

Fig 1 Maximum dissipation in percentage of rated power as a function of the ambient temperature for CR06 ,CR05, CR03, CR02

MOUNTING

Due to their rectangular shapes and small tolerances, Surface Mountable Resistors are suitable for handling by automatic placement systems. Chip placement can be on ceramic substrates and printed-circuit boards (PCBs). Electrical connection to the circuit is by individual soldering condition. The end terminations guarantee a reliable contact.

STORAGE AND HANDLING CONDITIONS

- 1) Products are recommended to be used up within two years since operation date as ensured shelf life. Check solderability in case shelf life extension is needed.
- 2) To store products with following condition: Temperature : 5 to 40°C Humidity: 20 to 70% relative humidity
- 3) Don't store products in a corrosive environment such as sulfide, chloride gas, or acid. It may cause oxidization of electrode, which easily be resulted in poor soldering b.To store products on the shelf and avoid exposure to moisture. Don't expose products to excessive shock, vibration, direct sunlight and so on.

THICK FILM CHIP RESISTORS CR06 SERIES

REFLOW SOLDERING CONDITION

The robust construction of chip resistors allows them to be completely immersed in a solder bath of 260 °C for 10 seconds. Therefore, it is possible to mount Surface Mount Resistors on one side of a PCB and other discrete components on the reverse (mixed PCBs). Surface Mount Resistors are tested for solderability at 235 °C during 2 seconds. The test condition for no leaching is 260°C for 30 seconds. Typical examples of soldering processes that provide reliable joints without any damage are given in Fig 2.

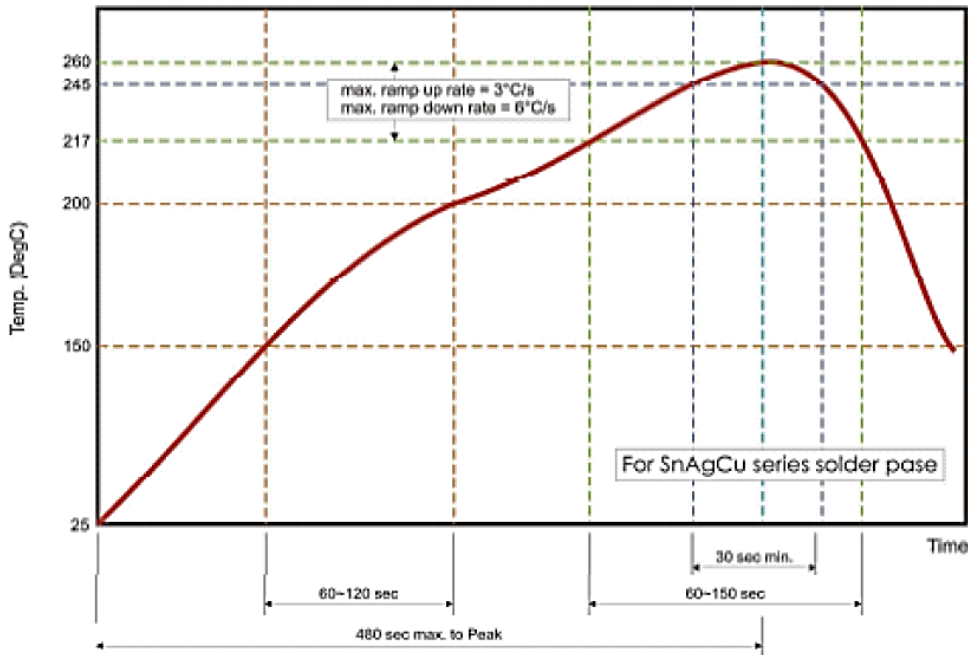

Fig 2. Infrared soldering profile for Chip Resistors

TEST AND REQUIREMENTS

Essentially all tests are carried out according to the schedule of IEC publication 115-8, category **LCT/UCT/56**(rated temperature range: **Lower Category Temperature, Upper Category Temperature**; damp heat, long term, 56 days). The testing also meets the requirements specified by EIA, EIAJ and JIS. The tests are carried out in accordance with IEC publication 68, "Recommended basic climatic and mechanical robustness testing procedure for electronic components" and under standard atmospheric conditions according to IEC 60068-1, subclause 5.3. Unless otherwise specified, the following value supplied

Temperature: 15 °C to 35 °C. Relative humidity: 45% to 75%.

Air pressure: 86kPa to 106 kPa (860 mbar to 1060 mbar).

All soldering tests are performed with mildly activated flux.

THICK FILM CHIP RESISTORS CR06 SERIES
TEST AND REQUIREMENT (JIS C 5201-1 : 1998)

| TEST | PROCEDURE / TEST METHOD | REQUIREMENT | |
|--|--|--|-------|
| | | Resistor | Ω |
| Electrical Characteristics JIS C 5201-1: 1998 Clause 4.8 | - DC resistance values measurement - Temperature Coefficient of Resistance (T.C.R) Natural resistance change per change in degree centigrade. $\frac{R_2 - R_1}{R_1(t_2 - t_1)} \times 10^6 \text{ (ppm/}^\circ\text{C)}$ t1 : 20°C+5°C-1°C; t2 : -55°C or +155°C R1 : Resistance at reference temperature (20°C+5°C/- 1°C) R2: Resistance at test temperature (-55°C or +155°C) | Within the specified tolerance Refer to “QUICK REFERENCE DATA” | <50mΩ |
| Resistance To Soldering Heat(R.S.H) JIS C 5201-1:1998 Clause 4.18 | Un-mounted chips completely immersed for 10±1 second in a SAC solder bath at 260°C±5°C | ±5%: ΔR/R max. ±(1%+0.05Ω); ±1%: ΔR/R max. ±(0.5%+0.05Ω) no visible damage | <50mΩ |
| Solderability JIS C 5201-1: 1998 Clause 4.17 | Un-mounted chips completely immersed for 2±0.5 second in a SAC solder bath at 235°C±5°C | 95% coverage min., good tinning and no visible damage | |
| Temperature cycling JIS C 5201-1: 1998 Clause 4.19 | 30 minutes at -55°C±3°C, 2~3 minutes at 20°C+5°C-1°C, 30 minutes at +125°C±3°C, 2~3 minutes at 20°C+5°C-1°C, total 5 continuous cycles | ±5%: ΔR/R max. ±(1%+0.05Ω); ±1%: ΔR/R max. ±(0.5%+0.05Ω) no visible damage | <50mΩ |
| High Temperature Exposure MIL-STD-202 method 108 | 1000+48/-0 hours; without load in a temperature chamber controlled 155 ± 3 °C | ±5%: ΔR/R max. ±(2%+0.1Ω); ±1%: ΔR/R max. ±(1%+0.1Ω) no visible damage | <50mΩ |

THICK FILM CHIP RESISTORS CR06 SERIES

TEST AND REQUIREMENT (JIS C 5201-1 : 1998)

| TEST | PROCEDURE / TEST METHOD | REQUIREMENT | |
|---|--|--|-------|
| | | Resistor | Ω |
| Bending strength JISC5201-1: 1998 Clause 4.33 | Resistors mounted on a 90mm glass epoxy resin PCB(FR4), bending once 3mm for 10sec, 5mm for CR02 | ±5%: ΔR/R max. ±(1%+0.05Ω); ±1%: ΔR/R max. ±(1%+0.05Ω) no visible damage | <50mΩ |
| Adhesion JISC5201-1: 1998 Clause 4.32 | Pressurizing force: 5N, Test time: 10±1sec | No remarkable damage or removal of the terminations | |
| Short Time Overload (STOL) JISC5201-1: 1998 Clause 4.13 | 2.5 times RCWV or max. overload voltage, for 5seconds | ±5%: ΔR/R max. ±(2%+0.05Ω); ±1%: ΔR/R max. ±(1%+0.05Ω) no visible damage | <50mΩ |
| Load life in Humidity JISC5201-1: 1998 Clause 4.24 | 1000 +48/-0 hours, loaded with RCWV or Vmax in humidity chamber controller at 40 C 2 C and 90~95% relative humidity, 1.5hours on and 0.5 hours off | ±5%: ΔR/R max. ±(2%+0.1Ω); ±1%: ΔR/R max. ±(1%+0.1Ω) no visible damage | <50mΩ |
| Load life (endurance) JISC5201-1: 1998 Clause 4.25 | 1000 +48/-0 hours, loaded with RCWV or Vmax in chamber controller 70±2°C, 1.5 hours on and 0.5 Hours off | ±5%: ΔR/R max. ±(3%+0.1Ω); ±1%: ΔR/R max. ±(1%+0.1Ω) no visible damage | <50mΩ |
| Insulation Resistance JISC5201-1: 1998 Clause 4.6 | Apply the maximum overload voltage (DC) for 1minute | R ≥ 10GΩ | |
| Dielectric Withstand Voltage JISC5201-1: 1998 Clause 4.7 | Apply the maximum overload voltage (AC) for 1 minute | No breakdown or flashover | |

6/5/2023

THICK FILM CHIP RESISTORS CR06 SERIES
REEL DIMENSION (Unit: mm)

7": 5,000Ppcs/Reel

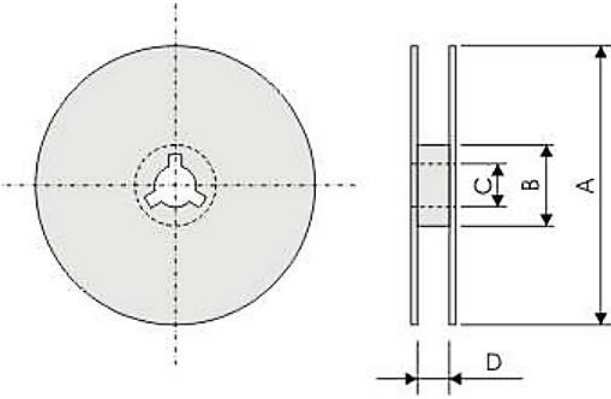

| Code | Dimension 7" | Dimension 10" | Dimension 13" |
|------|--------------|---------------|---------------|
| A | 178.0+/-2.0 | 254.0+/-2.0 | 330.0+/-2.0 |
| B | 60.0 +/-1.0 | 100 +/-1.00 | 100+/-1.00 |
| C | 13.0+/-0.20 | 13.0+/-0.20 | 13.0+/-0.20 |
| T | 9.00+/-0.50 | 9.00+/-0.50 | 9.00+/-0.50 |

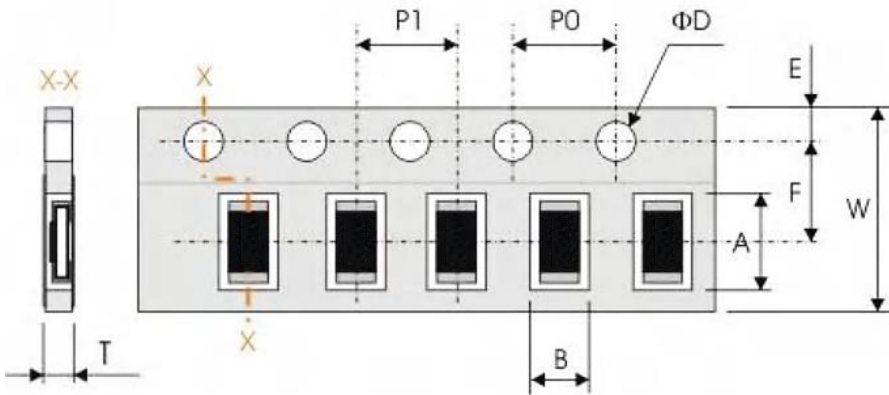
TAPE DIMENSION (Unit: mm)

| Code | Dimension |
|------|-------------|
| A | 3.60+/-0.20 |
| B | 2.00+/-0.20 |
| W | 8.00±0.30 |
| F | 3.50±0.20 |
| E | 1.75±0.10 |
| P 1 | 4.00±0. 10 |
| P0 | 4.00±0.10 |
| ΦD | 1.50±0.10 |
| T | 1.0 Max. |

TAPING QUANTITY AND TAPE MATERIAL

| Tape | Paper Tape | | | | | | Embossed Tape | Bulk Cassette |
|-----------|------------|-------|-------|------------|-----|-----|---------------|---------------|
| | 4 mm Pitch | | | 2 mm Pitch | | | 4 mm Pitch | |
| Reel Size | 7" | 10" | 13" | 7" | 10" | 13" | 7" | |
| CR06 | 5000 | 10000 | 20000 | | | | - | 5000 |

THICK FILM CHIP RESISTORS CR06 SERIES

PERFORMANCE OF TAPING

Strength of Carrier Tape and Top Cover Tape

Carrier Tape: When a tensile force 1.02kgf is applied in the direction of unreeling the tape, the tape shall withstand this force. Top cover Tape: When a tensile force 1.02kgf is applied to the tape, the tape shall withstand this force.

Peel Force of Top Cover Tape

Unless otherwise specified, the peel force of top cover tape shall be 10.2 to 71.4 g f when the top cover tape is pulled at a speed of 300mm/min with the angle between the taped during peel and the direction of unreeling maintained at 165 to 180° as illustrated in Fig.

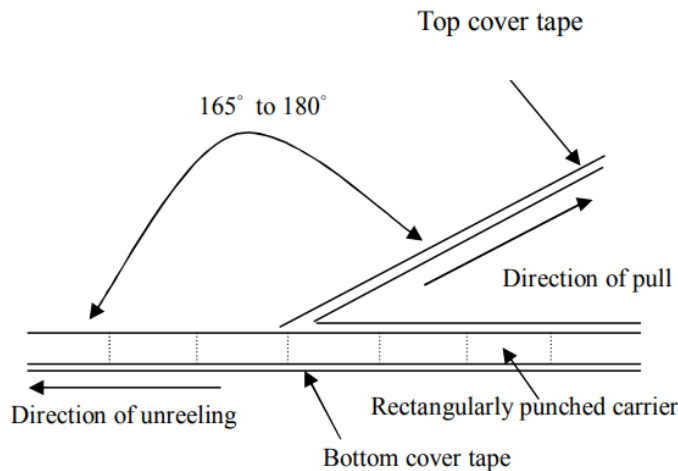

DISCLAIMER

NextGen Component, Inc. reserves the right to make changes to the product(s) and or information contained herein without notice. No liability is assumed as a result of their use or application. No rights under any patent accompany the sale of any such product(s) or information