



SPECIFICATION SHEET

SPECIFICATION SHEET NO.	Q0607- CRCL05FBR56S01
DATE	June. 7, 2023
REVISION	A0
DESCRIPTION	Thick Film Low Ohm Chip Resistors (High power rating and low TCR), 0805 (2012 Metric), CL05 Series, Dimension L2.00*W1.25*H0.50mm, 2 Terminations, Tolerance: ±1.0%, Resistance 0.56 ohm, Dissipation Max. 1/4W @ 70°C, Temperature Coefficient Rate (TCR) Max. ±100ppm/°C Operating Temp. Range -55°C ~+155°C Package in Tape/Reel, 5,000pcs/Reel RoHS/RoHS III compliant and HF
CUSTOMER	
CUSTOMER PART NUMBER	
CROSS REF. PART NUMBER	
ORIGINAL PART NUMBER	Aillen CL05FBR56
PART CODE	CRCL05FBR56S01

VENDOR APPROVE			
Issued/Checked/Approved			
DATE: June. 7, 2023			

CUSTOMER APPROVE	
DATE:	

6/7/2023

THICK FILM LOW OHM CL05 SERIES

DESCRIPTION

The resistors are constructed in a high grade ceramic body (aluminum oxide). Internal metal electrodes are added at each end and connected by a resistive paste that is applied to the top surface of the substrate. The composition of the paste is adjusted to give the approximate resistance required and the value is trimmed to within tolerance by laser cutting of this resistive layer. The resistive layer is covered with a protective coat. Finally, the two external end terminations are added. For ease of soldering the outer layer of these end terminations is a Tin (lead free) alloy.



MAIN FEATURE

- High power rating and low TCR
- High reliability and stability
- Reduced size of final equipment
- RoHS exemption free and Lead free products

APPLICATION

- Power supply / Battery Pack
- Battery charger/ PC
- DC-DC power converter

RFQ

[Request For Quotation](#)

PART CODE GUIDE

CRCL	05	F	B	R56	S01
1	2	3	4	5	6

- 1) **CRCL**: Product code for Thick Film Low Ohm Chip Resistors
- 2) **05**: Size Code, 0805 (2012 Metric), CL05 Series, Dimension L2.00*W1.25*H0.50mm,
- 3) **F**: Resistance Range Tolerance Code, P: Jumper; B: +/-0.1%; D: +/-0.5%; F: +/-1%; J: +/-5%
- 4) **B**: Package Code, A: 4Kpcs/7"Reel; B:5kpcs/7"Reel; C:10kpcs/7"Reel; M:15kpcs/7"Reel; D:10kpcs/10"Reel; E:20kpcs/10"Reel
- 5) **R56**: Resistance value code. 0R: 0ohm; R56: 0.56ohm; 15R: 15ohm; 20R: 20ohm; 39R: 39ohm; 51R: 51ohm; 100R: 100ohm; 390R: 390ohm; 1K:1Kohm; 1K87: 1.87Kohm; 4K7: 4.7Kohm; 10K: 10Kohm; 10K5: 10.5Kohm; 12K: 12 Kohm; 150K: 150Kohm; 226K: 226Kohm; 1M: 1.0Mohm; 1M2: 1.2Mohm
- 6) **S01**: Internal control code, digits and letter; Blank: N/A

THICK FILM LOW OHM CL05 SERIES

DIMENSION (Unit: mm)

Image for reference



General Marking:

4-digits marking

*Each resistor is marked with a four digits code on the protective coating to designate the nominal resistance value

CL05 series

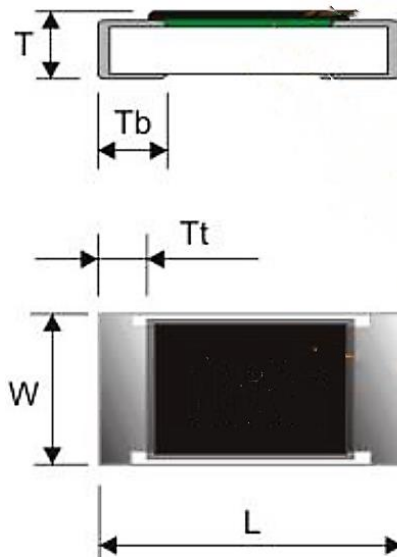

Item	Dimension
L	2.00±0.10
W	1.25±0.10
T	0.50±0.10
T b	0.40±0.20
T t	0.40±0.20

Resistors Construction For Reference

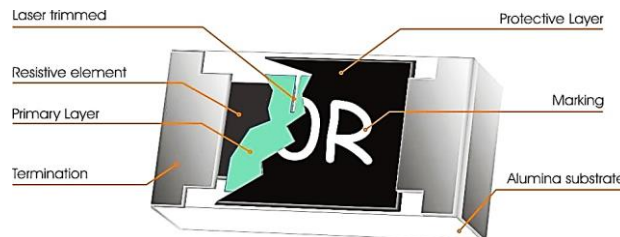

Recommended Solder Pad

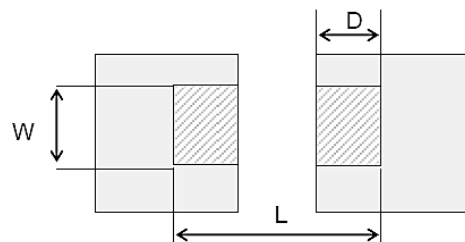

Item	Dimension
W	1.30
L	3.50
D	1.15

THICK FILM LOW OHM CL05 SERIES
GENERAL ELECTRONICAL CHARACTERISTICS

Item		Unit	Symbol	Characteristic	Condition
Product Name			CRCL	Thick Film Low Ohm Chip Resistors	
Size			05	CL05 Series, L2.00*W1.25*H0.50mm	
Resistance Range		Ω		0.56	
Resistance Tolerance		%	F	±1.0%	
TCR	20MΩ≥ R>10MΩ	ppm/°C		≤ ±1000	
	39MΩ≥ R>22MΩ			≤ ±600	
	47MΩ≥ R>40MΩ			≤ ±400	
	91MΩ≥ R>50MΩ			≤ ±200	
	910MΩ≥ R>100MΩ			≤ ±100	
Max. Dissipation		W		1/4	@ Tamb=70°C
Operating Temperature		°C		-55 ~+155	

1) This is the maximum voltage that may be continuously supplied to the resistor element, see “IEC publication 60115-8”

2) Max. Operation Voltage : So called RCWV (Rated Continuous Working Voltage) is determined by

$$RCWV = \sqrt{\text{Rated Power} \times \text{Resistance Value}} \text{ or Max. RCWV listed above, whichever is lower.}$$

3) Test condition for jumper (0 Ω)

PRODUCT CHARACTERIZATION

Standard values of nominal resistance are taken from the E24 & E96 series for resistors with a tolerance of $\pm 0.1\%$, $\pm 0.5\%$, $\pm 1\%$ & $\pm 5\%$. The values of the E24/E96 series are in accordance with "IEC publication 60063"

DERATING

The power that the resistor can dissipate depends on the operating temperature; see Fig.1

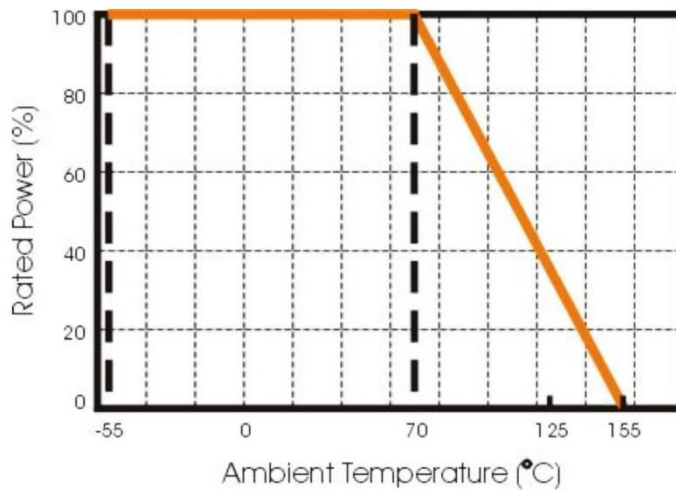

Fig 1 Maximum dissipation in percentage of rated power as a function of the ambient temperature

MOUNTING

Due to their rectangular shapes and small tolerances, Surface Mountable Resistors are suitable for handling by automatic placement systems. Chip placement can be on ceramic substrates and printed-circuit boards (PCBs). Electrical connection to the circuit is by individual soldering condition. The end terminations guarantee a reliable contact.

REFLOW SOLDERING CONDITION

The robust construction of chip resistors allows them to be completely immersed in a solder bath of 260 °C for 10 seconds. Therefore, it is possible to mount Surface Mount Resistors on one side of a PCB and other discrete components on the reverse (mixed PCBs). Surface Mount Resistors are tested for solderability at 235 °C during 2 seconds. The test condition for no leaching is 260°C for 30 seconds. Typical examples of soldering processes that provide reliable joints without any damage are given in Fig 2.

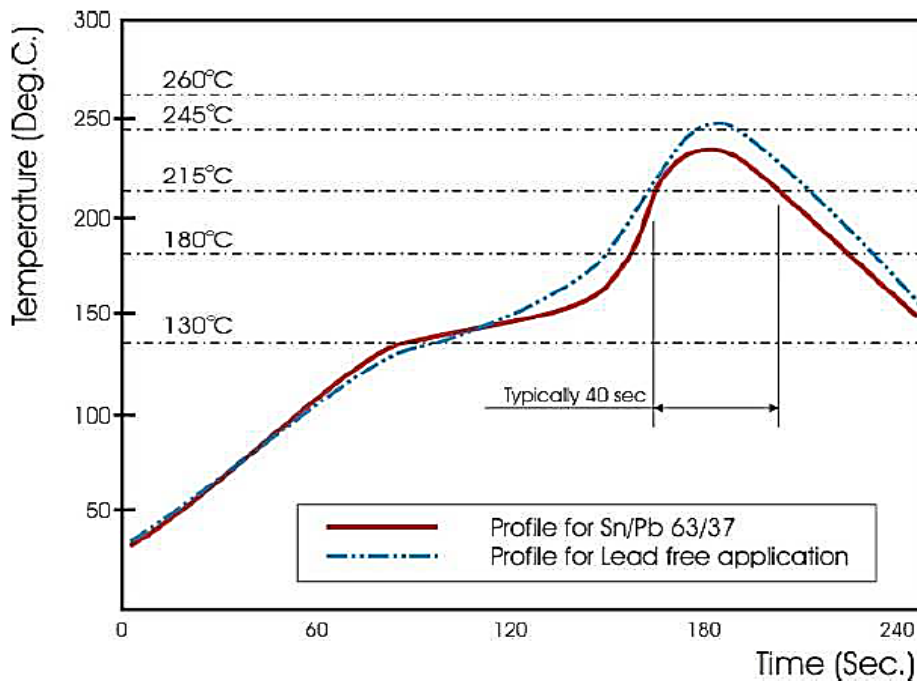

Fig 2. Infrared soldering profile for Chip Resistors

THICK FILM LOW OHM CL05 SERIES
TEST AND REQUIREMENT (JIS C 5201-1 : 1998)

TEST	PROCEDURE / TEST METHOD	REQUIREMENT
Temperature Coefficient of Resistance(T.C.R) Clause 4.8	Natural resistance change per change in degree centigrade. $\frac{R_2 - R_1}{R_1(t_2 - t_1)} \times 10^6 \text{ (ppm/}^\circ\text{C)}$ t1 : 25°C R1 : Resistance at reference temperature 25°C R2: Resistance at test temperature 155°C	Within the specified tolerance Refer to “QUICK REFERENCE DATA”
Short time overload (S.T.O.L) Clause 4.13	Permanent resistance change after a 5second application of a 5 times rated power.	J: Δ R/R max. ±(2%+0.5mΩ) F: Δ R/R max. ±(1%+0.5mΩ)
Resistance to soldering heat(R.S.H) Clause 4.18	Un-mounted chips completely immersed for 10±1second in a SAC solder bath at 260°C±5°C	J: Δ R/R max. ±(1%+0.5mΩ) F: Δ R/R max. ±(0.5%+0.5mΩ) no visible damage
Solderability Clause 4.17	Un-mounted chips completely immersed for 2±0.8 second in a SAC solder bath at 235°C±5°C	95% coverage min., good tinning and no visible damage
Temperature cycling Clause 4.19	30 minutes at -55°C±3°C, 2~3 minutes at 20°C+5°C-1°C, 30 minutes at +125°C±3°C, 2~3 minutes at 20°C+5°C1°C, total 5 continuous cycles	J: Δ R/R max. ±(1%+0.5mΩ) F: Δ R/R max. ±(0.5%+0.5mΩ) no visible damage
Damp Heat (Load life in humidity) Clause 4.24	1000 +48/-0 hours, loaded with RCWV or Vmax in humidity chamber controller at 40°C±2°C and 90~95% relative humidity, 1.5hours on and 0.5 hours off	J: Δ R/R max. ±(3%+0.5mΩ) F: Δ R/R max. ±(1%+0.5mΩ)
Load life (endurance) JISC5201-1: 1998 Clause 4.25	1000 +48/-0 hours, loaded with RCWV or Vmax in chamber controller 70±2°C, 1.5 hours on and 0.5 Hours off	J: Δ R/R max. ±(3%+0.5mΩ) F: Δ R/R max. ±(1%+0.5mΩ)
Bending strength Clause 4.33	Resistors mounted on a 90mm glass epoxy resin PCB(FR4); bending : 3mm for 0603/0805, 2mm for 1206 and above sizes, once for 10 seconds	J: Δ R/R max. ±(1%+0.5mΩ) F: Δ R/R max. ±(0.5%+0.5mΩ) no visible damage
Adhesion Clause 4.32	Pressurizing force: 5N, Test time: 10±1sec.	No remarkable damage or removal of the terminations
Insulation Resistance Clause 4.6	Test voltage: 100+/-15V	I.R≥1GΩ

THICK FILM CHIP RESISTORS CL05 SERIES
REEL DIMENSION (Unit: mm)

7": 5,000Ppcs/Reel

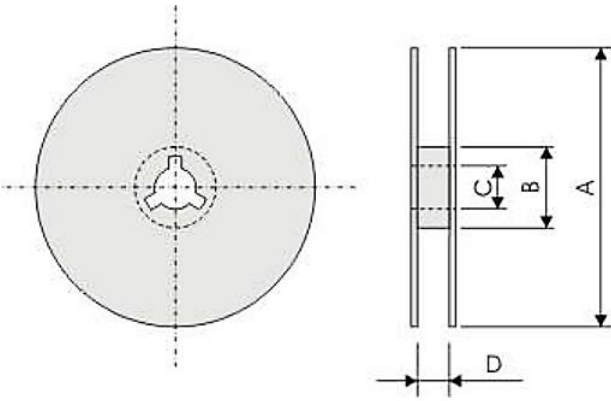

Code	Dimension 7"	Dimension 10"	Dimension 13"
A	178.0+/-2.0	254.0+/-2.0	330.0+/-2.0
B	60.0 +/-1.0	100 +/-1.0	100+/-1.0
C	13.0+/-0.20	13.0+/-0.20	13.0+/-0.20
D	10.0±1.5	10.0±1.5	10.0±1.5

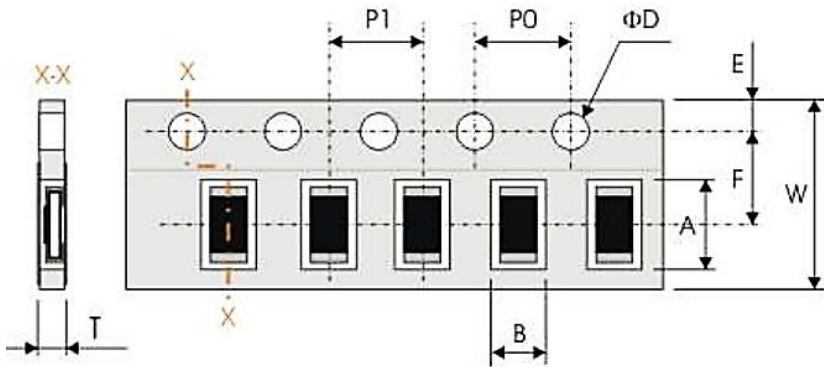
TAPE DIMENSION (Unit: mm)

Code	Dimension
A	2.40±0.20
B	1.65±0.20
W	8.00±0.30
F	3.50±0.20
E	1.75±0.10
P 1	4.00±0.10
P0	4.00±0.10
ΦD	1.50±0.10
T	1.0 Max.

TAPING QUANTITY AND TAPE MATERIAL

Tape	Paper Tape						Embossed Tape	Bulk Cassette
	4 mm Pitch			2 mm Pitch			4 mm Pitch	
Reel Size	7"	10"	13"	7"	10"	13"	7"	
CL05	5000	10000	20000	-	-	-	-	10000

PERFORMANCE OF TAPING

Strength of Carrier Tape and Top Cover Tape

Carrier Tape: When a tensile force 1.02kgf is applied in the direction of unreeling the tape, the tape shall withstand this force. Top cover Tape: When a tensile force 1.02kgf is applied to the tape, the tape shall withstand this force.

Peel Force of Top Cover Tape

Unless otherwise specified, the peel force of top cover tape shall be 10.2 to 71.4 g f when the top cover tape is pulled at a speed of 300mm/min with the angle between the taped during peel and the direction of unreeling maintained at 165 to 180° as illustrated in Fig.

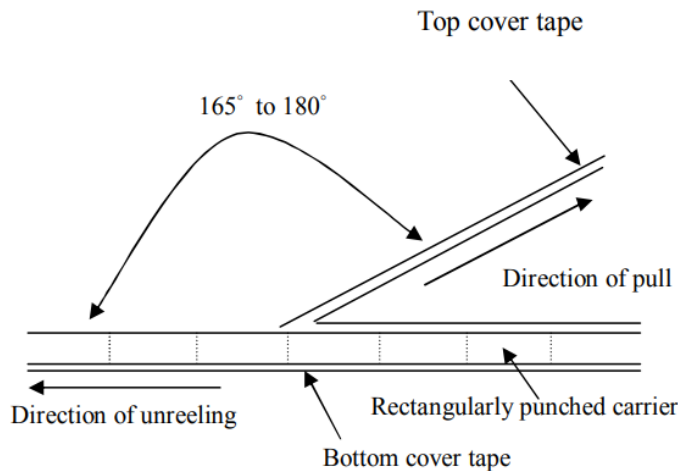

DISCLAIMER

NextGen Component, Inc. reserves the right to make changes to the product(s) and or information contained herein without notice. No liability is assumed as a result of their use or application. No rights under any patent accompany the sale of any such product(s) or information