



**SPECIFICATION SHEET**

<b>SPECIFICATION SHEET NO.</b>	Q0301- XB22M11840S416
<b>DATE</b>	March 01, 2023
<b>REVISION</b>	A0
<b>DESCRIPTION</b>	MHz SMD Crystal, Seam Seal, L7.0*W5.0*H1.1mm, 4 Pads, CM75 series 22.1184MHz, Tolerance +/-30ppm, Load Capacitor 16pF, Frequency stability +/-30ppm @Operating Temp. Range -40°C ~+85°C, ESR 30 ohm Max, Reflow Profile Condition 260 °C Max. Tape/Reel, 1000pcs/Reel RoHS/RoHS III compliant
<b>CUSTOMER</b>	
<b>CUSTOMER PART NUMBER</b>	
<b>CROSS REF. PART NUMBER</b>	
<b>ORIGINAL PART NUMBER</b>	TGS CM75 22M1184A30-16-30-40-30TLF
<b>PART CODE</b>	XB22M11840S416

<b>VENDOR APPROVE</b>			
Issued/Checked/Approved			
DATE: March 01, 2023			

<b>CUSTOMER APPROVE</b>	
DATE:	

03/01/2023

**MAIN FEATURE**

- SMD Crystal, Seam Seal, L7.0\*W5.0\*H1.1mm, 4 pads
- Low cost, High precision, High frequency stability
- Reflow Profile Condition 260 °C Max.
- Cross more competitors part
- RoHS/RoHS III compliant



**APPLICATION**

- Bluetooth, wireless communication set
- Communication Electronics

**PART CODE GUIDE**

**RFQ**

[Request For Quotation](#)

XB	22M11840	S	416
1	2	3	4

1) XB: Part family Code for SMD Crystal, Seam Seal, L7.0\*W5.0\*H1.1mm, 4 pads (CM75)

2) 22M11840: Frequency range code for 22.1184MHz

3) S: SMD type, Package Tape/Reel, 1000pcs/Reel

4) 416: Specification code for original part No.: **TGS CM75 22M1184A30-16-30-40-30TLF**

**DIMENSION (Unit: mm)**

Image for reference

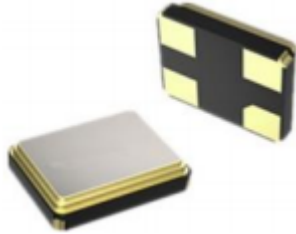

CM75

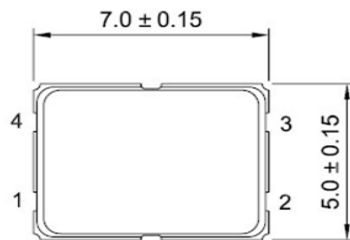

**Marking**  
standard

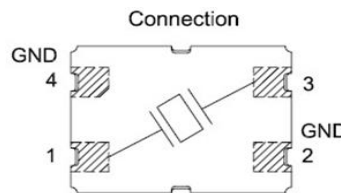
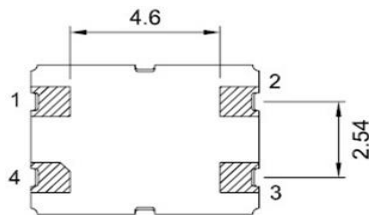

**Connection**  
#1 Crystal  
#2 Ground  
#3 Crystal  
#4 Ground

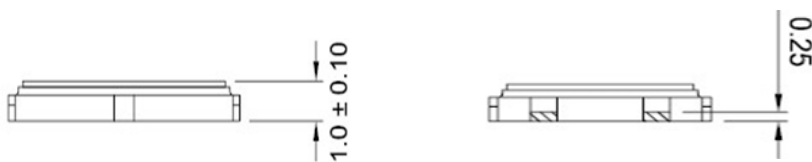

**Recommend Pad Layout**

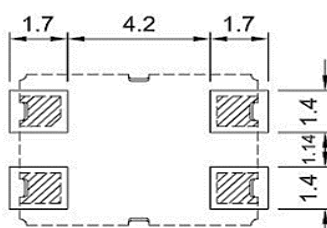

**ELECTRICAL PARAMETERS**

Parameter	Part No. Symbol	Units	Value			Condition
			Min.	Typical	Max.	
Original Manufacturer	TGS	TGS Crystals				
Holder Type	CM75	SMD Crystal, Seam Seal, L7.0*W5.0*H1.1mm, 4 pads				
Frequency Range	22M1184	MHz	22.1184			
Mode of Oscillation	A	AT Fundamental				
Frequency Tolerance	30	ppm	-30		+30	@25°C
Load Capacitance	-16	pF	16			
Stability over Operation Temperature	-30	ppm	-30		+30	
Operation Temperature	-40	°C	-40		+85	
Storage Temperature		°C	-55		+125	
Equivalent Series Resistance (ESR)	-30	Ω			30	
Drive Level		μW			300	
Shunt Capacitance (C0)		pF	0		7.0	
Motional Capacitance (C1)		fF	N/A			
DLD2		Ω	N/A			
FLD2		ppm	N/A			
RDL2		Ω	N/A			
SPDB		dB	N/A			
Aging		ppm/year			±3	@1 <sup>st</sup> year
Insulation Resistance		MΩ	500			@100VDC ± 15VDC
Others	Package	T	Tape/Reel			
	RoHS Status	LF	RoHS III compliant			
	Add Value		N/A			
	Internal Control Code *		N/A			

Note: 1) Original Part Number: **TGS CM75 22M1184A30-16-30-40-30TLF**

2) \* Internal Control Code- 2 letter or digits; Blank: N/A

03/01/2023

**MECHANICAL PERFORMANCE**

Item	Condition	Standard
Drop characteristics	Free drop from 75cm height on a hard wooden board for 3 times. (Board is thickness more than 30 mm.)	Frequency change: ≤5ppm Rr as specification
Shake characteristics	Shake frequency 10~55Hz, cyc1~2 minutes, swing 1.5mm, direction x/y/z, all 30 minutes, test after 1 hours.	Frequency change: ≤5ppm Rr as specification
Airproof characteristics	Put crystal into the pressure cabin with alcohol, keep pressure 0.4~0.5mpa 10 minutes, then take out and blow for 5 minutes	IR≥500MΩ
Weld characteristics	260±5°C, 3 seconds	90% exhibit tin ok
Humidity characteristics	+40±2°C & 90%~95% R.H. 250 hours	Frequency change: ≤5ppm Rr as specification
Low temperature characteristics	-30±2°C, 250 hours, put in room temperature, test after 1 hours.	Frequency change: ≤5ppm Rr as specification
High temperature characteristics	+85±2°C, 250 hours, put in room temperature, test after 1 hours.	Frequency change: ≤5ppm Rr as specification
Temperature cycling	-30±3°C/30±3 min~+85±2°C/30±3min, 5 cycles	Frequency change: ≤5ppm Rr as specification

**SUGGESTED REFLOW PROFILE (For Reference Only)**

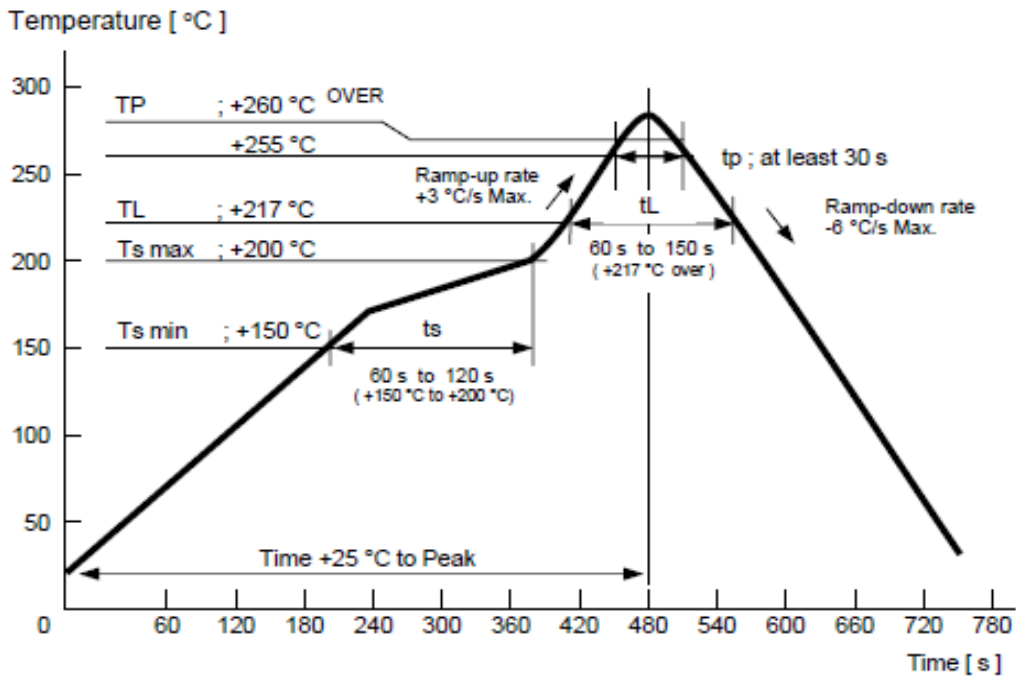

**TAPE/REEL (Unit: mm)**

All Devices are packed in accordance with EIA standard RS-481-2 and specifications., 1000pcs/Reel

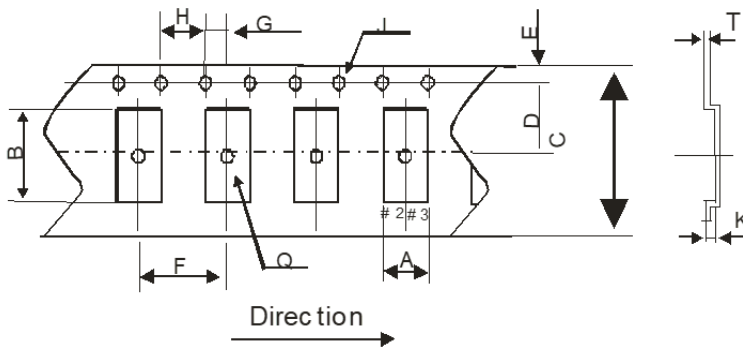
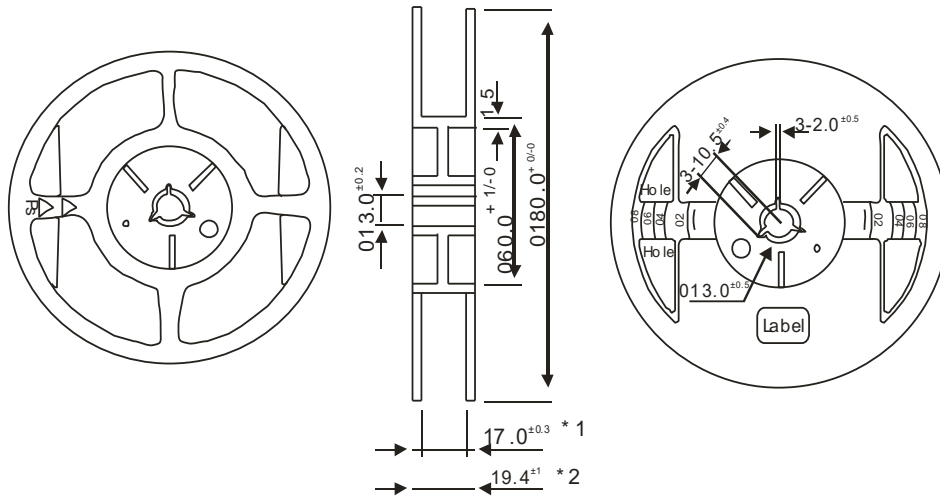

A	5.4 <sup>±0.1</sup>
B	7.4 <sup>±0.1</sup>
C	16.0 <sup>±0.2</sup>
D	7.5 <sup>±0.1</sup>
E	1.75 <sup>±0.1</sup>
F	8.0 <sup>±0.1</sup>
G	2.0 <sup>±0.1</sup>
H	4.0 <sup>±0.1</sup>
J	1.55 <sup>±0.05</sup>
K	1.4 <sup>±0.1</sup>
Q	1.6 <sup>+0.1/0</sup>
T	0.3 <sup>±0.05</sup>

Item		Empty Space
Tapa Leader	Cover Tape	Min.500mm
	Empty Pockets	Min.20 pockets
Tape Trailer	Cover Tape	Min.0mm
	Empty Pockets	Min.40mm

**DISCLAIMER**

NextGen Components, Inc. reserves the right to make changes to the product(s) and or information contained herein without notice. No liability is assumed as a result of their use or application. No rights under any patent accompany the sale of any such product(s) or information

03/01/2023