



SPECIFICATION SHEET

SPECIFICATION SHEET NO.	Q1028- NC1D120C30KTNG	
DATE	Oct. 28, 2023	
REVISION	A1	Updated With Most Recent Data -RoHS/REACH Test Report Link
DESCRIPTION AND MAIN PARAMETRICS	<p>Silicon Carbide (SiC) Enhanced Junction Barrier Schottky Diode (EJBS), TO-247-2L, NC1D Series, 2 Pins, Industrial Grade</p> <p>Repetitive Peak Reverse Voltage (VRRM): 1200V, Continuous Forward Current (IF) @Tc 152°C: 30A, Operating Junction Temperature Range (Tj,Max): 175°C</p> <p>Package in Tube, 30pcs/Tube</p> <p>RoHS/RoHS III compliant and HF Free</p>	
CUSTOMER		
CUSTOMER PART NO.		
CROSS REF. PART NO.		
ORIGINAL MFG/PART NO.	NovuSem/NC1D120C30KT	
PART CODE	NC1D120C30KTNG	

VENDOR APPROVE			
Issued/Checked/Approved			
DATE: Oct. 28, 2023			

CUSTOMER APPROVE
DATE:

SILICON CARBIDE (SiC) SCHOTTKY DIODE TO2472L NC1D SERIES

DESCRIPTION

Silicon Carbide (SiC) Enhanced Junction Barrier Schottky (EJBS) diode is cost-effective, quality-oriented, and is proven in accordance with industrial standards. SiC Schottky Diode is a composite structure of a PiN Diode and SBD structure. The PiN structure, in the reverse blocking state of the device, is used to shield the electric field of the Schottky region to reduce leakage current. The SBD structure realizes the low forward voltage through unipolar conduction. NovuSem has developed a SiC EJBS diode through the optimization of device structure and manufacturing process, The SiC EJBS diode features ultra-low leakage current (5 μ A) and high surge current capability comparable to that of the MPS (Merged PiN Schottky) structure.

MAIN FEATURE

- High Surge Current Capability
- Low Leakage Current
- No Reverse Recovery Current/Forward Recovery Voltage
- 175 °C Operating Junction Temperature
- Low Forward Voltage (VF) Drop With Positive Temperature Coefficient
- Temperature-Independent Switching Behavior
- RoHS III Compliant & HF Free



APPLICATION

- PV Inverters
- Charging Piles
- Energy Storage Systems
- Industrial Power Supply
- Industrial Motors
- Automotive Electronics.

SILICON CARBIDE (SiC) SCHOTTKY DIODE TO2472L NC1D SERIES

APPLICATION PERFORMANCE

- 1100V PV System Boost PFC: In the application of 11kW PV inverters, compared with FRD, NovuSem SiC EJBS diode reduces system loss by 30%, and reduces temperature increases in silicon-based IGBTs and SiC diodes by 6°C and 13°C respectively, greatly improving overall power density.
- Vienna rectifier for 20 kW charging piles: Novusem SiC EJBS diode improves system efficiency by 1.05% while reducing switching loss by 91% and total loss by 50% compared to FRD.

RFQ
[Request For Quotation](#)

PART CODE GUIDE

NC1D	120	C	30	K	T	NG
1	2	3	4	5	6	7

1. NC1D: NovuSem Silicon Carbide (SiC) Schottky Diode Gen 1 Industrial Grade series code
2. 120: Repetitive Peak Reverse Voltage (V RRM) code, 120: 1200V; 65: 650V
3. C: Material code, C: SiC; S: Silicon
4. 30: Continuous Forward Current (I F) @ Tc 152°C Code: 30: 30A.
5. K: Package/Case code, A: TO-220-2L; D: TO-252; F: TO-220F; G: TO-247-3L; H: TO-247-4L; K: TO-247-2L; M: DFN5X6 R: TO-263-7L; S: TO-263; T: TO-220-3L
6. T: Packing type code, T: Tube; R: Tape & Reel
7. NG: Internal Control Code, letter or digits (A~Z or 1~9) for Special Parametric; Blank: N/A

SILICON CARBIDE (SiC) SCHOTTKY DIODE TO2472L NC1D SERIES

DIMENSION – See Table 1 (Unit: mm)

1). All dimensions are listed in millimeters, angles are in degrees. 2). All Metal Surfaces are Tin Plate (Matte) except Area of Cut.

Image for Reference



Marking:

Line 1: Initial Part Code

Line 2/Line 3: Internal QC Code

Package/Case: TO-247-2L

Table 1

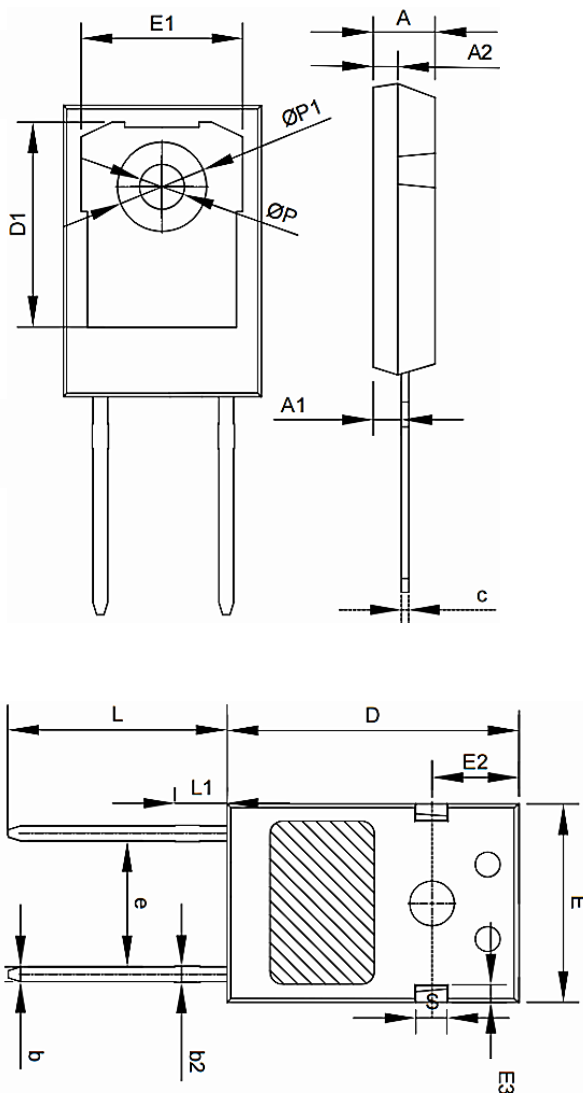

SYMBOL	TO-247-2L		
	Min.	Typ.	Max.
A	4.80	5.00	5.20
A1	2.21	2.41	2.61
A2	1.85	2.00	2.15
b	1.11	1.21	1.36
b2	1.91	2.01	2.21
c	0.51	0.61	0.75
D	20.70	21.00	21.20
D1	16.25	16.55	16.85
E	15.50	15.80	16.10
E1	13.00	13.30	13.60
E2	4.08	5.00	5.20
E3	2.30	2.50	2.70
e	10.88 Basic		
L	19.62	19.92	20.22
L1	-	-	4.30
S	6.15 Basic		
ØP	3.40	3.60	3.80
ØP1	-	-	7.30

SILICON CARBIDE (SiC) SCHOTTKY DIODE TO2472L NC1D SERIES

INTERNAL CIRCUIT DIAGRAM

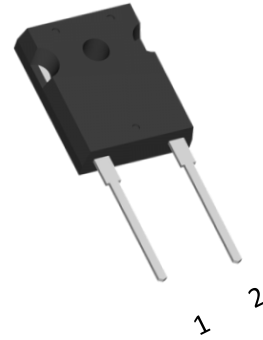
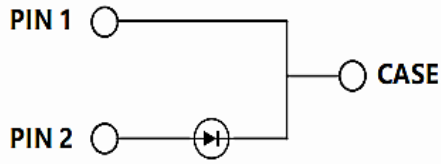

1200V SiC SCHOTTKY DIODE

VRRM	IF @ Tc = 152°C	Tj, Max.	PACKAGE/CASE
1200V	30A	175 °C	TO-247-2L

MAX. RATINGS @Tc=25 °C (unless otherwise specified)

PARAMETER	SYMBOL	TEST CONDITIONS	VALUE	UNIT
Repetitive Peak Reverse Voltage	VRRM		1200	V
DC Peak Reverse Voltage	VR		1200	V
Continuous Forward Current	IF	Tc=25°C	89	A
		Tc=135°C	42	
		Tc=152°C	30	
Repetitive Peak Forward Surge Current	IFRM	Tc=25°C, tp=10ms, half sine wave, 0.1Hz	250	A
Non-Repetitive Forward Surge Current	IFSM	Tc=25°C, tp=10ms, half sine wave	270	A
Power Dissipation	Ptot	Tc=25°C	405	W
		Tc=110°C	176	
i ² t Value	∫i ² dt	Tc=25°C, tp=10ms	362	A ² s
Operating Junction Tempe. Range	Tj		-55 ~ +175	°C
Storage Temperature Range	Tstg		-55 ~ +175	°C

SILICON CARBIDE (SiC) SCHOTTKY DIODE TO2472L NC1D SERIES
ELECTRICAL CHARACTERISTICS @Tc=25 °C (Unless Otherwise Specified)

PARAMETER	SYMBOL	CONDITIONS	VALUE			UNIT
			Min.	Typ.	Max.	
Forward Voltage	VF	IF=20A, Tj=25°C	-	1.41	1.6	V
		IF=20A, Tj=175°C	-	2.00	2.50	
Reverse Current	IR	VR=1200V, Tj=25°C	-	11	85	µA
		VR=1200V, Tj=175°C	-	55	300	
Total Capacitance	C	VR=0.1V, f=1MHz	-	2125	-	pF
		VR=400V, f=1MHz	-	146	-	
		VR=800V, f=1MHz	-	116	-	
Total Capacitive Charge	Qc	VR =800V, T j=25°C	-	160	-	nC
Capacitance Stored Energy	Ec	VR=800V	-	65	-	µJ

THERMAL CHARACTERISTICS

PARAMETER	SYMBOL	VALUE			UNIT
		Min.	Typ.	Max.	
Thermal Resistance from Junction to Case	R θJC	-	0.37	-	°C/W

SILICON CARBIDE (SiC) SCHOTTKY DIODE TO2472L NC1D SERIES

TYPICAL PERFORMANCE (For Reference Only)

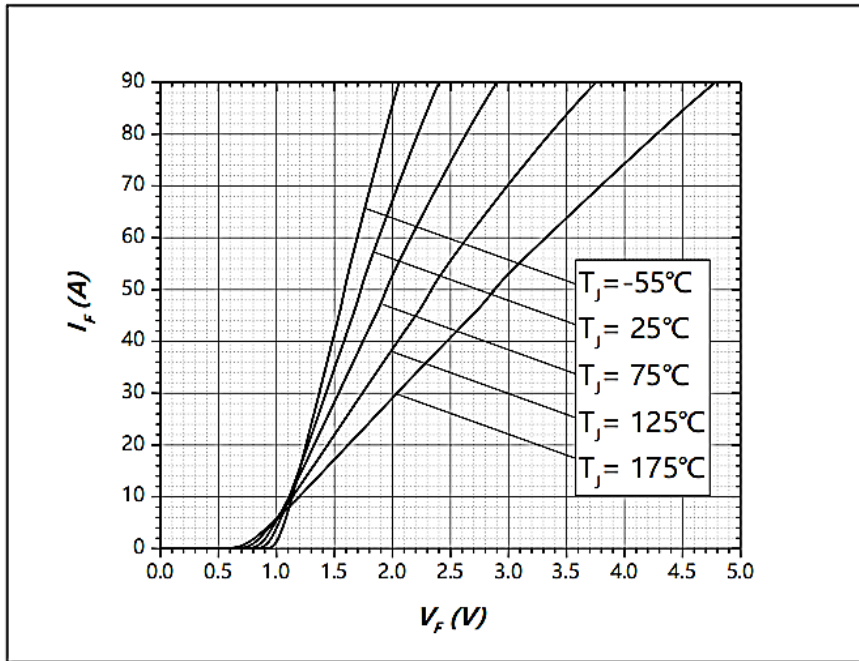

Figure 1. Forward Characteristics

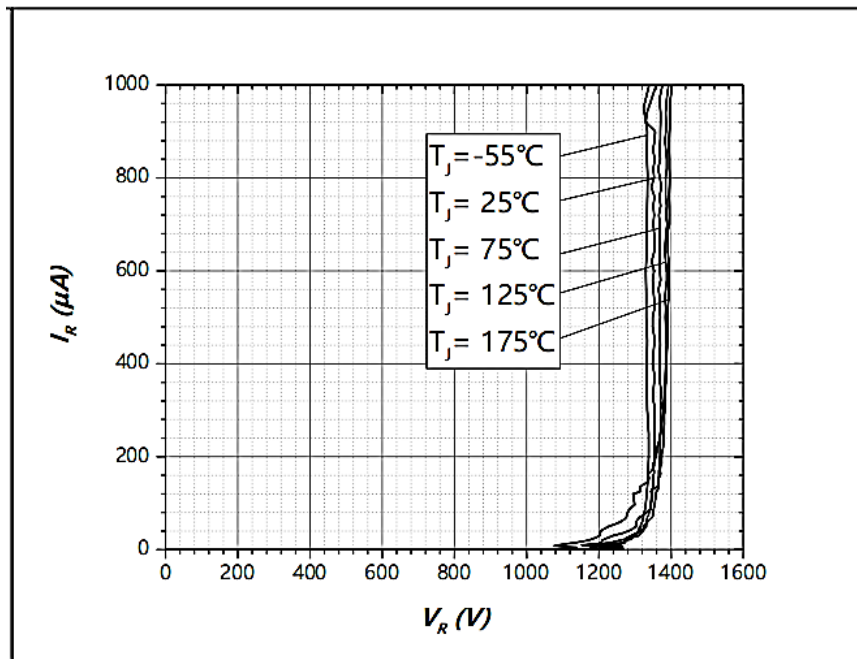

Figure 2. Reverse Characteristics

SILICON CARBIDE (SiC) SCHOTTKY DIODE TO2472L NC1D SERIES

TYPICAL PERFORMANCE (For Reference Only)

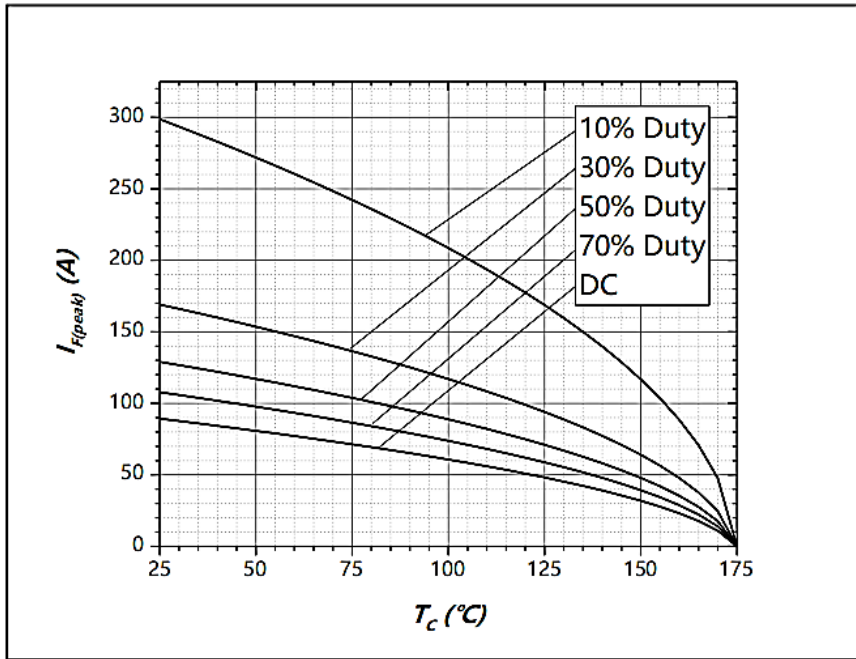

Figure 3. Current Derating

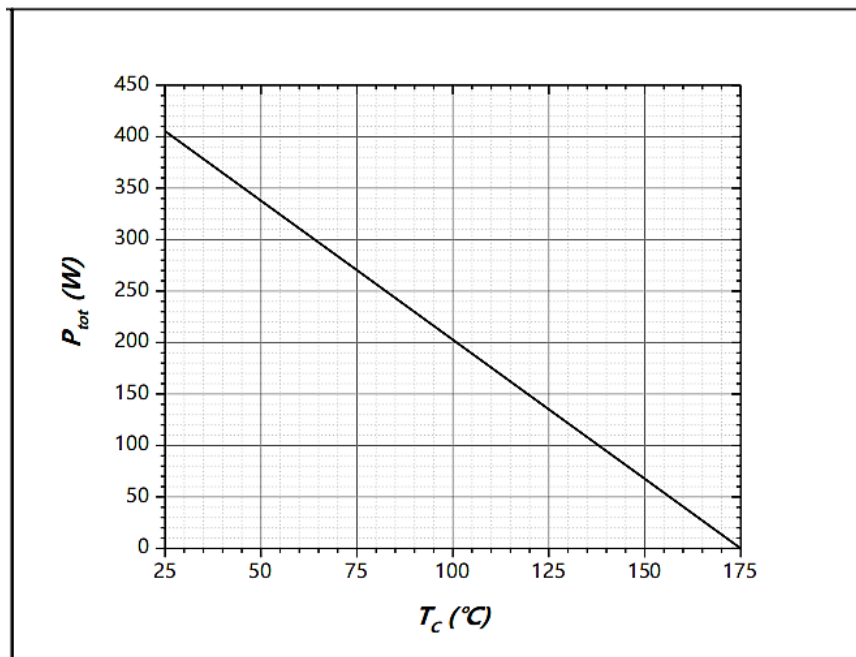

Figure 4. Power Derating

SILICON CARBIDE (SiC) SCHOTTKY DIODE TO2472L NC1D SERIES

TYPICAL PERFORMANCE (For Reference Only)

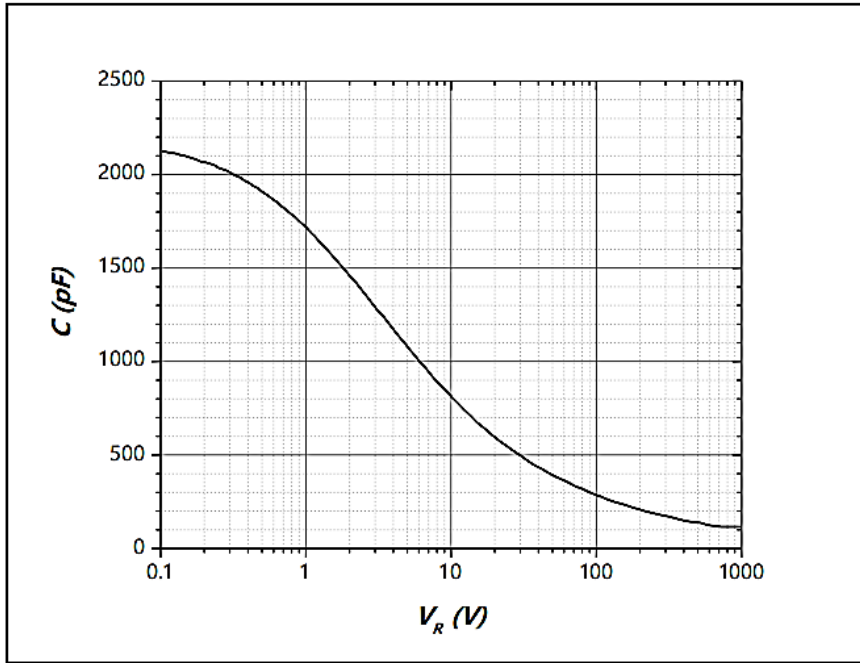

Figure 5. Capacitance vs. Reverse Voltage

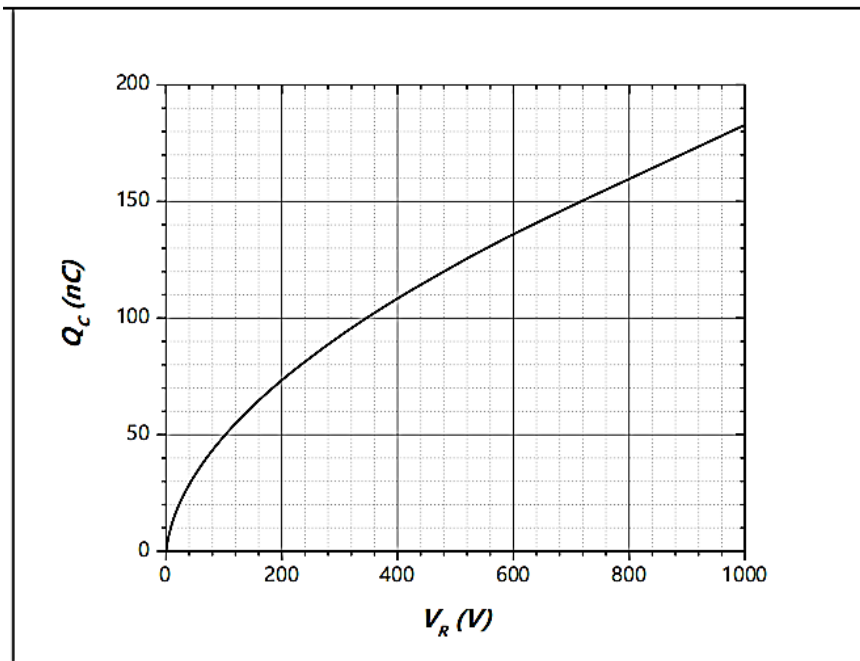

Figure 6. Total Capacitance Charge vs. Reverse Voltage

SILICON CARBIDE (SiC) SCHOTTKY DIODE TO2472L NC1D SERIES

TYPICAL PERFORMANCE (For Reference Only)

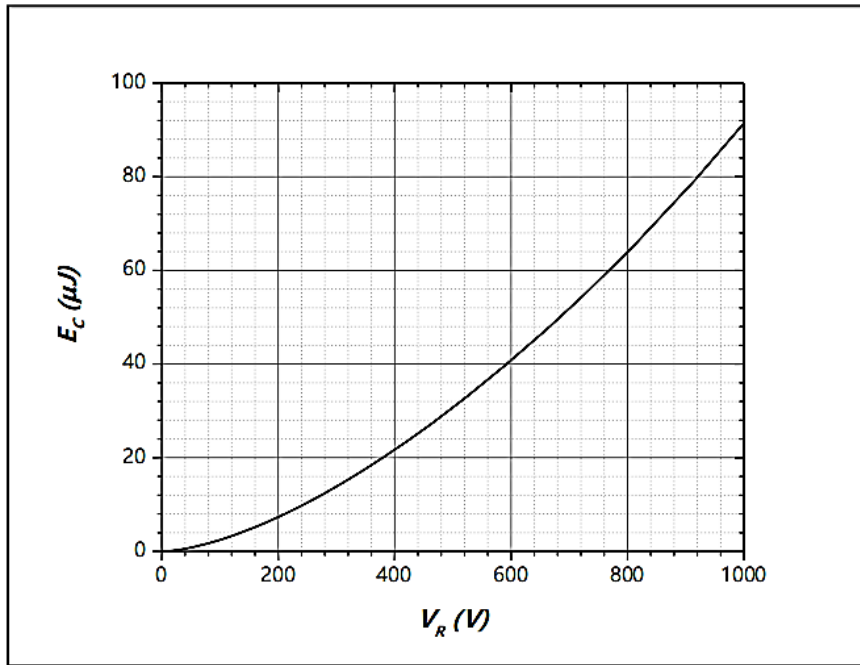

Figure 7. Capacitance Stored Energy

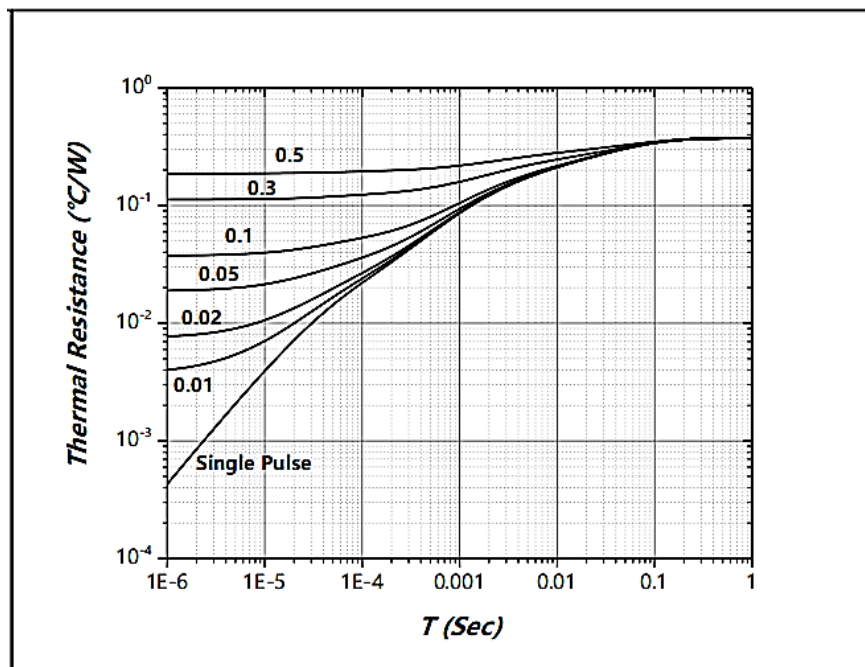

Figure 8. Transient Thermal Impedance

SILICON CARBIDE (SiC) SCHOTTKY DIODE TO2472L NC1D SERIES

ROHS COMPLIANCE

- The levels of RoHS restricted materials in this product are below the maximum concentration values (also referred to as the threshold limits) permitted for such substances, or are used in an exempted application, in accordance with EU RoHS Directive (EU) 2015/863 EC (RoHS3). RoHS Test Report for this product can be obtained can be obtained at Download Center.

REACH COMPLIANCE

- REACH substances of high concern (SVHCs) information is available for this product. Since the European Chemical Agency (ECHA) has published notice of their intent to frequently revise the SVHC listing for the foreseeable future, REACH Test Report for this product can be obtained can be obtained at Download Center.

IMPORTANT NOTES AND DISCLAIMER

- 1) All Product parametric performance is indicated in the Electrical Characteristics for the listed herein test conditions, unless otherwise noted. Product performance may not be indicated by the Electrical Characteristics if operated under different conditions.
- 2) NextGen Component, Inc (*NextGen*) reserves the right to make changes to this document and its products and specifications at any time without notice. Customers should obtain and confirm the latest product information and specifications before final design, purchase or use.
- 3) *NextGen* makes no warranty, representation or guarantee regarding the suitability of its products for any particular purpose, nor does NextGen assume any liability for application assistance or customer product design.
- 4) *NextGen* does not warrant or accept any liability with products which are purchased or used for any unintended or unauthorized application. No license is granted by implication or otherwise under any intellectual property rights of NextGen.
- 5) *NextGen* products are not authorized for use as critical components in life support devices or systems without express written approval by *NextGen*.
- 6) *NextGen* requires that customers first obtain an RMA (Returned Merchandise Authorization) number prior to returning any products. Returns must be made within 30 days of the date of invoice, be in the original packaging, unused and like-new condition. At the time of quoting or purchasing, a product may say that it is Non-Cancelable/ Non-Returnable (NCNR). These products are not returnable and not refundable.