



**SPECIFICATION SHEET**

<b>SPECIFICATION SHEET NO.</b>	Q1028- NC1M120C12HTNG	
<b>DATE</b>	Oct. 28, 2023	
<b>REVISION</b>	A1	Updated With Most Recent Data -RoHS/REACH Test Report Link
<b>DESCRIPTION AND MAIN PARAMETRICS</b>	<p>Silicon Carbide (SiC) MOSFET, TO-247-4L, NC1M Series, 4 Pins  N-Channel, Drain-Source Voltage (V<sub>DS</sub>): 1200V, Industrial Grade  Continuous Drain Current (I<sub>D</sub>) @25°C: 214A  Drain-Source On-State Resistance R<sub>DS(ON)</sub>: 12 mOhm  Operating Temperature: -55°C ~ 175°C (TJ)  Package in Tube  RoHS/RoHS III/REACH Compliant and HF Free</p>	
<b>CUSTOMER</b>		
<b>CUSTOMER PART NO.</b>		
<b>CROSS REF. PART NO.</b>		
<b>ORIGINAL MFG/PART NO.</b>	NovuSem/NC1M120C12HT	
<b>PART CODE</b>	NC1M120C12HTNG	

<b>VENDOR APPROVE</b>			
Issued/Checked/Approved			
DATE: Oct. 28, 2023			

<b>CUSTOMER APPROVE</b>	
DATE:	

## SILICON CARBIDE (SiC) MOSFET TO2474L NC1M SERIES

### DESCRIPTION

Silicon Carbide (SiC) MOSFET is produced to spec in accordance by NovuSem with industrial standards. The cost-effective NC1M series products drastically lower both static and dynamic losses. In higher frequency applications, our products can shrink system components such as inductors, capacitors, filters, and transformers, which can increase the overall power density and reduce the total system cost.

### MAIN FEATURE

- Low Switching Loss
- Short-circuit Capability(>3 $\mu$ s).
- High Avalanche Ruggedness
- 175°C Operating Junction Temperature
- High Blocking Voltage With Low On-resistance
- High Speed Switching With Low Capacitances
- Fast Intrinsic Diode With Low Reverse Recovery (Q rr)
- RoHS/RoHS III/REACH Compliant and HF Free



### APPLICATION

- PV Inverters
- Charging Piles
- Energy Storage Systems
- Industrial Power Supply
- Industrial Motors.

**SILICON CARBIDE (SiC) MOSFET TO2474L NC1M SERIES**

**PART CODE GUIDE**

**RFQ**

[Request For Quotation](#)

NC1M	120	C	12	H	T	NG
1	2	3	4	5	6	7

1. NC1M: NovuSem Silicon Carbide (SiC) MOSFET Gen 1 Industrial Grade series code
2. 120: Drain-Source Voltage (V<sub>DS</sub>) code, 120: 1200V; 65: 650V
3. C: Material code, C: SiC; S: Silicon
4. 12: Drain-Source On-State Resistance R<sub>DS(ON)</sub> Code, 12: 12mOhm
5. H: Package/Case code, A: TO-220-2L; D: TO-252; F: TO-220F; G: TO-247-3L; H: TO-247-4L; K: TO-247-2L; M: DFN5X6, R: TO-263-7L; S: TO-263; T: TO-220-3L
6. T: Packing type code, T: Tube; R: Tape & Reel
7. NG: Internal Control Code, letter or digits (A~Z or 1~9) for Special Parametric; Blank: N/A

**SILICON CARBIDE (SiC) MOSFET TO2474L NC1M SERIES**

**DIMENSION** – See Table 1 (Unit: mm)

1). All dimensions are listed in millimeters, angles are in degrees. 2). All Metal Surfaces are Tin Plate (Matte) except Area of Cut.

Image for reference



Marking:

Line 1: Initial Part Code

Line 2/Line 3: Internal QC Code

Package/Case: TO-247-4L

Table 1

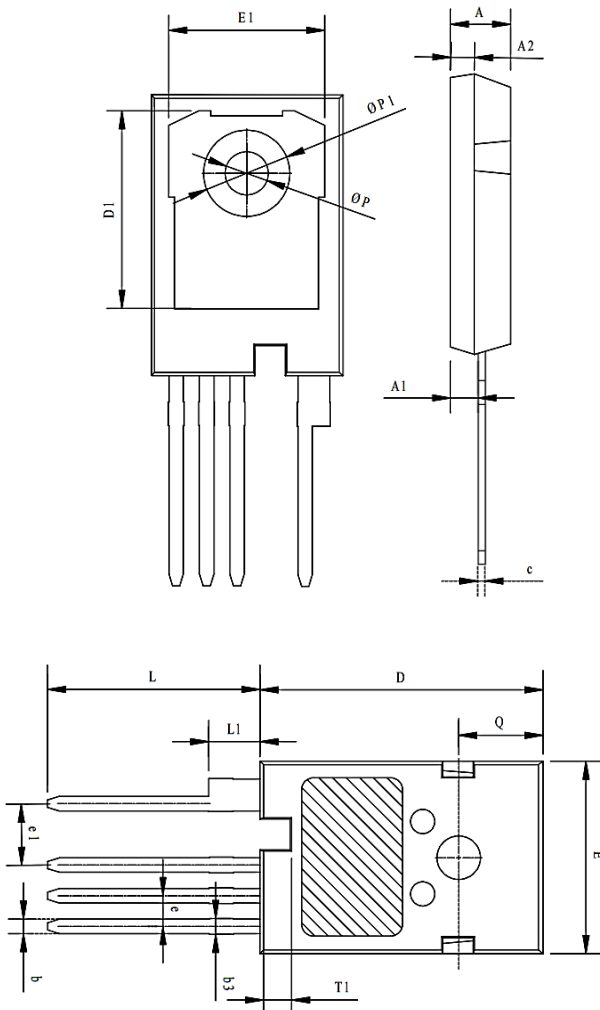

SYMBOL	TO-247-4L		
	Min.	Typ.	Max.
A	4.80	5.00	5.20
A1	2.21	2.41	2.61
A2	1.80	2.00	2.15
b	1.06	1.21	1.36
b1	2.33	2.63	2.93
b3	1.07	1.30	1.60
c	0.51	0.61	0.75
D	23.30	23.45	23.60
D1	16.25	16.55	16.85
E	15.74	15.94	16.14
E1	13.74	14.02	14.32
T1	2.35	2.5	2.65
e	2.54 Basic		
e1	5.08 Basic		
Q	5.49	5.79	6.00
L	17.27	17.57	17.82
L1	3.99	4.19	4.37
$\Phi P$	3.40	3.60	3.80
$\Phi P1$	7.19 Ref.		

## SILICON CARBIDE (SiC) MOSFET TO2474L NC1M SERIES

### INTERNAL CIRCUIT DIAGRAM

Pin 1 (D): Drain; Pin 2 (S): Power Source; Pin 3 (S): Driver Source; Pin 4 (G): Gate

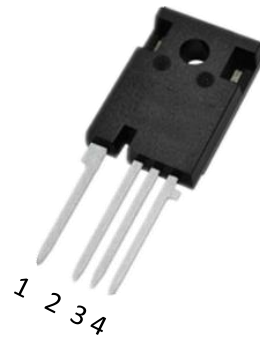
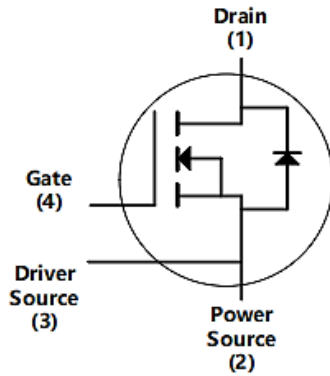

### 1200V N-CHANNEL SiC MOSFET

V <sub>DS</sub>	I <sub>D</sub> @ 25°C	R <sub>DS(on)</sub>	PACKAGE/CASE
1200V	214A	12mΩ	TO-247-4L

### MAX. RATINGS @T<sub>c</sub>=25 °C (Unless Otherwise Specified)

PARAMETER	SYMBOL	TEST CONDITIONS	VALUE	UNIT
Drain-Source Voltage	V <sub>DSMax</sub>	V <sub>GS</sub> =0V, I <sub>D</sub> =100μA	1200	V
Gate-Source Voltage	V <sub>GSop</sub>	Static	-5/+20	V
Max. Gate-Source Voltage	V <sub>GSMax</sub>	Static	-8/+22	V
Continuous Drain Current	I <sub>D</sub>	V <sub>GS</sub> =20V, T <sub>c</sub> =25°C	214	A
		V <sub>GS</sub> =20V, T <sub>c</sub> =100°C	151	
Pulsed Drain Current	I <sub>D</sub> (pulse)	Pulse width t <sub>p</sub> limited by T <sub>jmax</sub>	400	A
Power Dissipation	P <sub>D</sub>	T <sub>c</sub> =25°C, T <sub>j</sub> =175°C	938	W
Operating Junction Temperature Range	T <sub>J</sub>		-55 ~ +175	°C
Storage Temperature Range	T <sub>STG</sub>		-55 ~ +175	°C

**SILICON CARBIDE (SiC) MOSFET TO2474L NC1M SERIES**
**ELECTRICAL CHARACTERISTICS @Tc=25 °C (Unless Otherwise Specified) – Part 1**

PARAMETER	SYMBOL	CONDITIONS	VALUE			UNIT
			Min.	Typ.	Max.	
Drain-Source Breakdown Voltage	$V_{(BR)DSS}$	$V_{GS}=0V, I_D=100\mu A$	1200	-	-	V
Gates Threshold Voltage	$V_{GS(th)}$	$V_{DS}=V_{GS}, I_D=40mA$	2.0	2.7	3.5	V
		$V_{DS}=V_{GS}, I_D=40mA,$ $T_j=175^\circ C$	-	1.9	-	
Zero Gates Voltage Drain Crurent	$I_{DSS}$	$V_{DS}=1200V, V_{GS}=0V$	-	2	100	$\mu A$
Gates-Source Leakage Crurent	$I_{GSS}$	$V_{GS}=20V, V_{DS}=0V$	-	10	100	nA
Drain-Source On-State Resistance	$R_{DS(ON)}$	$V_{GS}=20V, I_D=100A$	-	12	20	m $\Omega$
		$V_{GS}=20V, I_D=100A,$ $T_j=175^\circ C$	-	20	-	
		$V_{GS}=18V, I_D=100A,$	-	13	25	
		$V_{GS}=18V, I_D=100A,$ $T_j=175^\circ C$	-	21	-	
Transconductance	$g_{fs}$	$V_{DS}=20V, I_{DS}=100A$	-	60	-	S
		$V_{DS}=20V, I_{DS}=100A,$ $T_j=175^\circ C$	-	52	-	
Turn-On Switching Energy (Body Diode FWD)	$E_{on}$	$V_{DS}=800V,$ $V_{GS}=-5V/20V, I_D=100A,$	-	5.2	-	mJ
Turn-Off Switching Energy (Body Diode FWD)	$E_{off}$	$R_G(ext)=5\Omega, L=100\mu H,$ $T_j=25^\circ C$ FWD=NC1M120C12HT	-	3.7	-	mJ
Turn-On Delay Time	$t_{d(on)}$	$V_{DD}=800V,$	-	24	-	ns
Rise Time	$t_r$	$V_{GS}=-5V/20V,$ $I_D=100A,$	-	149	-	ns
Turn-Off Delay Time	$t_{d(off)}$	$R_G(ext)=5\Omega, L=100\mu H$	-	145	-	ns
Fall Time	$t_f$		-	49	-	ns

**SILICON CARBIDE (SiC) MOSFET TO2474L NC1M SERIES**
**ELECTRICAL CHARACTERISTICS @Tc=25 °C (Unless Otherwise Specified) – Part 2**

PARAMETER	SYMBOL	CONDITIONS	VALUE			UNIT
			Min.	Typ.	Max.	
Gate to Source Charge	Q <sub>gs</sub>	V <sub>DS</sub> =800V, V <sub>GS</sub> =-5V/20V, I <sub>D</sub> =100A		215	-	nC
Gate to Drain Charge	Q <sub>gd</sub>			179	-	nC
Total Gate Charge	Q <sub>g</sub>			577	-	nC
Input Capacitance	C <sub>iss</sub>	V <sub>GS</sub> =0V, V <sub>DS</sub> =1000V f=1MHz V <sub>AC</sub> =25mV		8330	-	pF
Output Capacitance	C <sub>oss</sub>			343	-	pF
Reverse Transfer Capacitance	C <sub>rss</sub>			57	-	pF
COSS Stored Energy	E <sub>oss</sub>			217	-	μJ
Internal Gate Resistance	R <sub>G (int)</sub>	f=1MHz, V <sub>AC</sub> =25mV		0.8	-	Ω

**REVERSE DIODE CHARACTERISTICS @Tc=25 °C (Unless Otherwise Specified)**

PARAMETER	SYMBOL	CONDITIONS	VALUE			UNIT
			Min.	Typ.	Max.	
Diode Forward Voltage	V <sub>SD</sub>	V <sub>GS</sub> =-5V, I <sub>SD</sub> =50A	-	4.7	7	V
		V <sub>GS</sub> =-5V, I <sub>SD</sub> =50A, T <sub>j</sub> =175°C	-	3.8	-	V
Continuous Diode Forward Current	I <sub>S</sub>	V <sub>GS</sub> =-5V	-	214	-	A
Reverse Recovery Time	t <sub>rr</sub>	V <sub>GS</sub> =-5V, I <sub>SD</sub> =100A V <sub>R</sub> =800V, di/dt=1597A/μs	-	46	-	ns
Reverse Recovery Charge	Q <sub>rr</sub>		-	1	-	μC
Peak Reverse Recovery Current	I <sub>rrm</sub>		-	37	-	A

**THERMAL CHARACTERISTICS**

PARAMETER	SYMBOL	VALUE			UNIT
		Min.	Typ.	Max.	
Thermal Resistance from Junction to Case	R <sub>θJC</sub>	-	0.16	-	°C/W
Thermal Resistance From Junction to Ambient	R <sub>θJC</sub>	-	32	-	°C/W

**SILICON CARBIDE (SiC) MOSFET TO2474L NC1M SERIES**

TYPICAL PERFORMANCE - For Reference Only

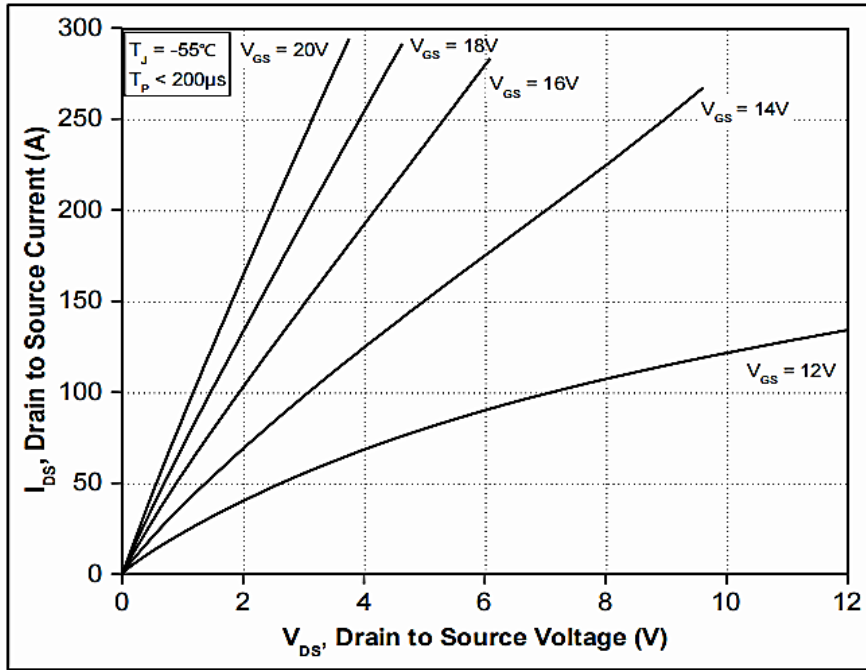

Figure 1. Output Characteristics  $T_J = -55^\circ\text{C}$

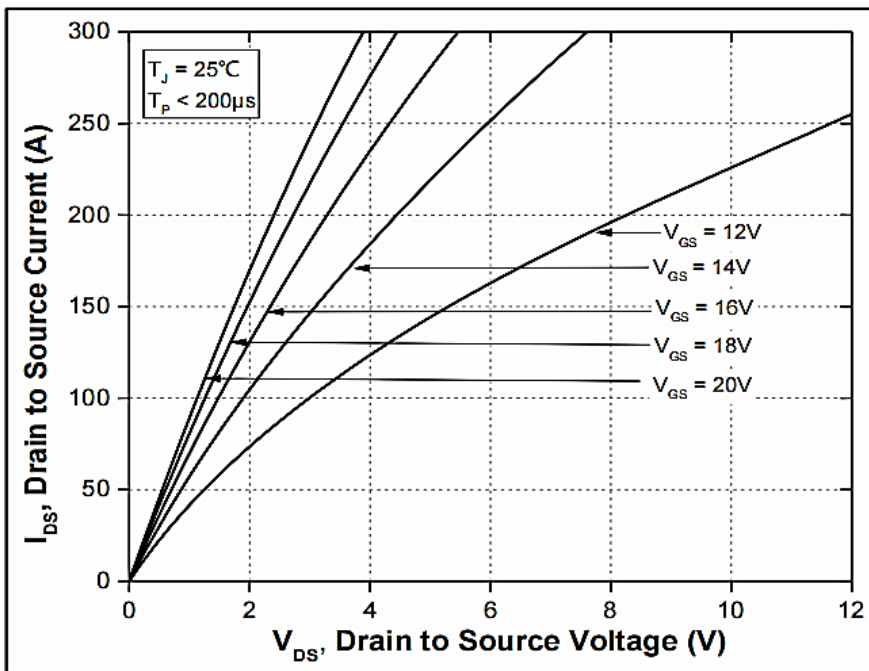

Figure 2. Output Characteristics  $T_J = 25^\circ\text{C}$



**SILICON CARBIDE (SiC) MOSFET TO2474L NC1M SERIES**

TYPICAL PERFORMANCE- For Reference Only

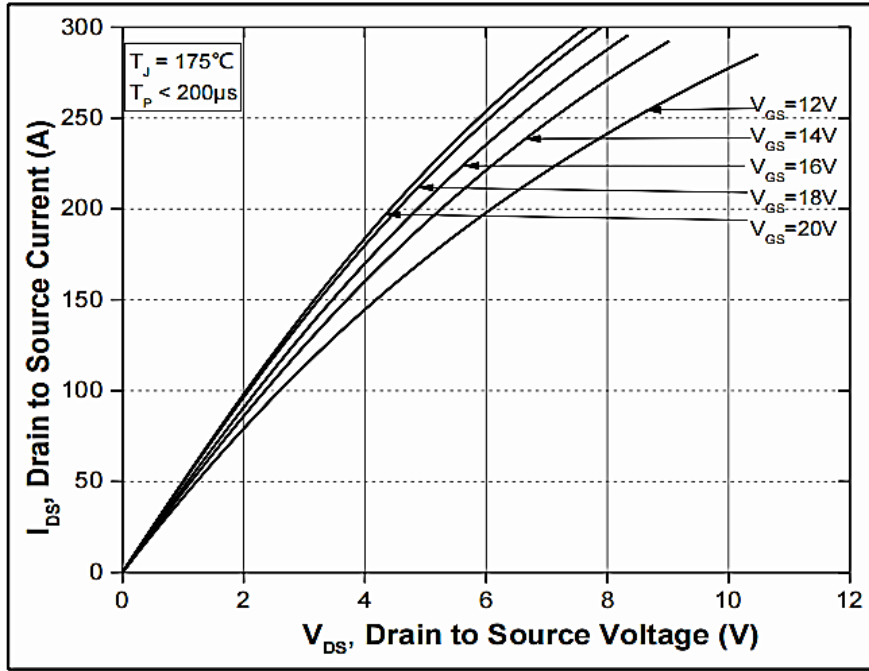

Figure 3. Output Characteristics  $T_J=175^\circ\text{C}$

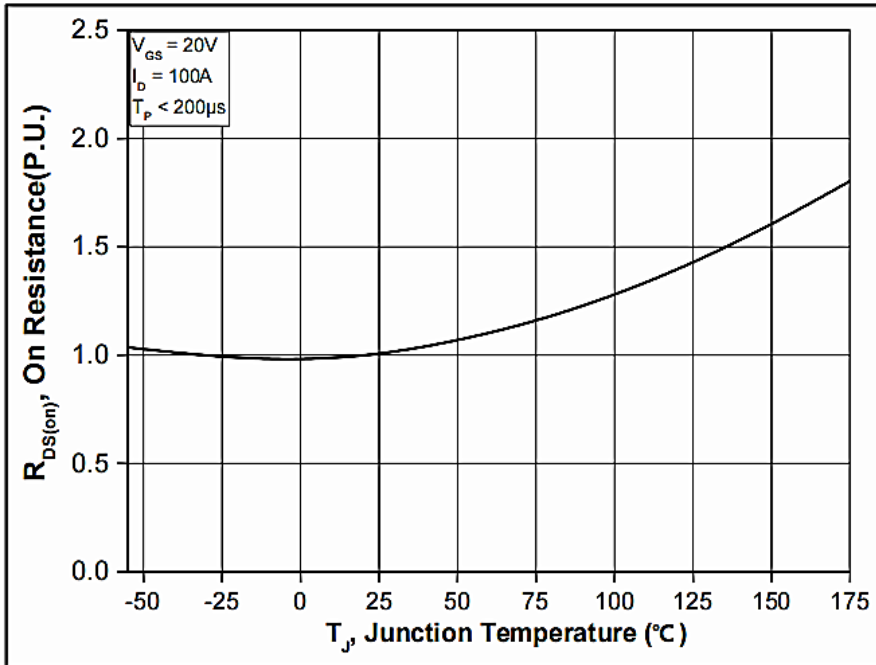

Figure 4. Normalized On-Resistance vs. Temperature

**SILICON CARBIDE (SiC) MOSFET TO2474L NC1M SERIES**

TYPICAL PERFORMANCE -For Reference Only

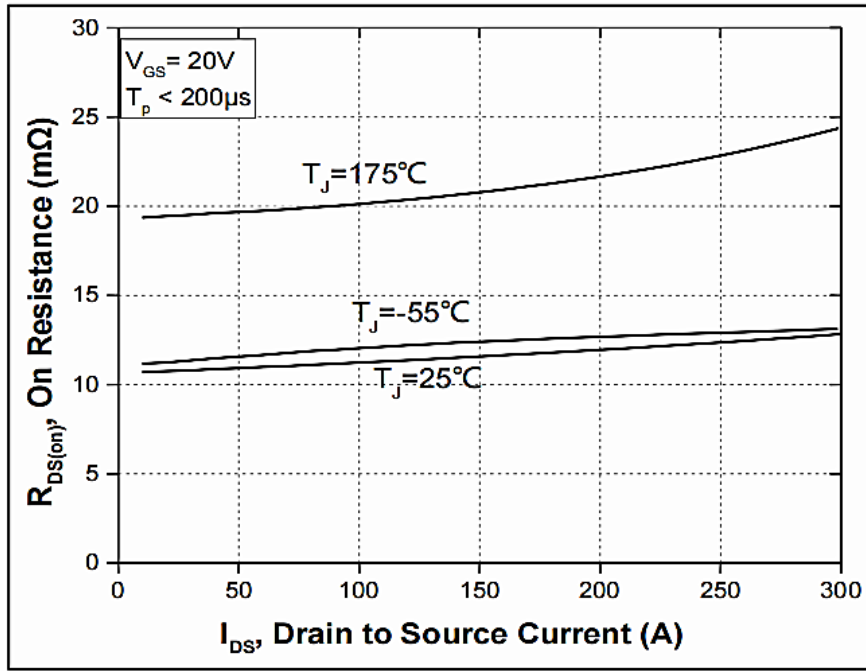

Figure 5. On-Resistance vs. Drain Current For Various Temperatures

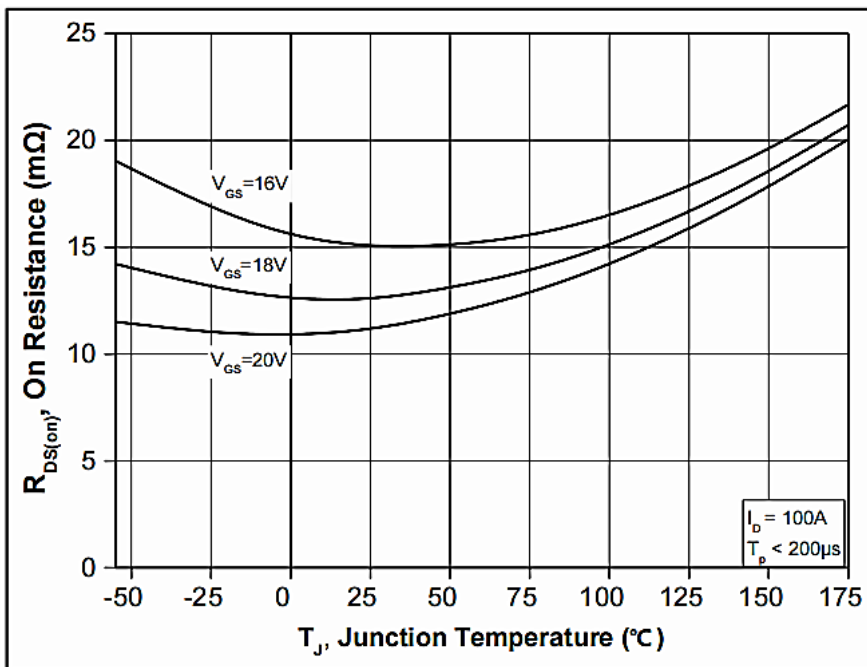

Figure 6. On-Resistance vs. Temperature For Various Gate Voltage

**SILICON CARBIDE (SiC) MOSFET TO2474L NC1M SERIES**

TYPICAL PERFORMANCE For Reference Only

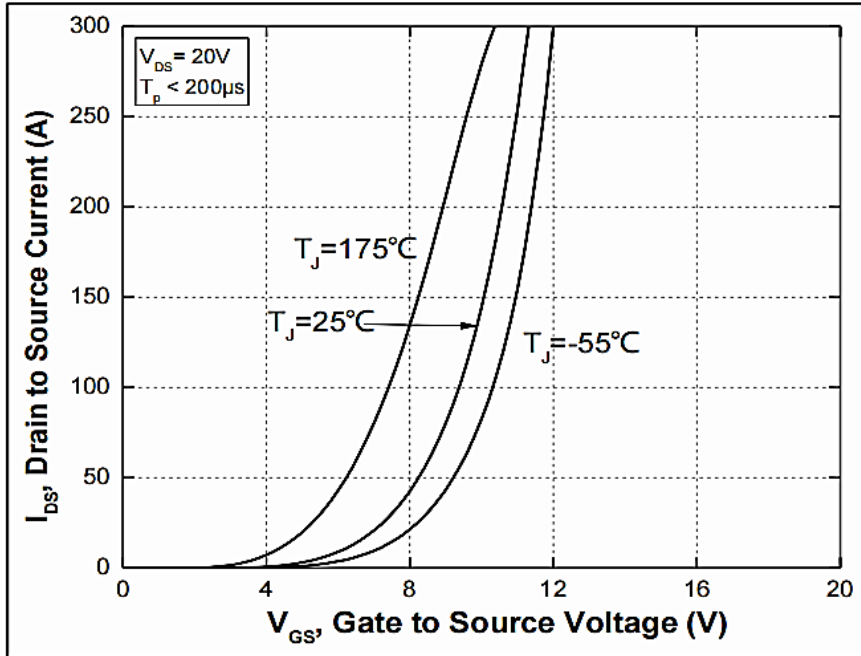

Figure 7. Transfer Characteristic for Various Junction Temperatures

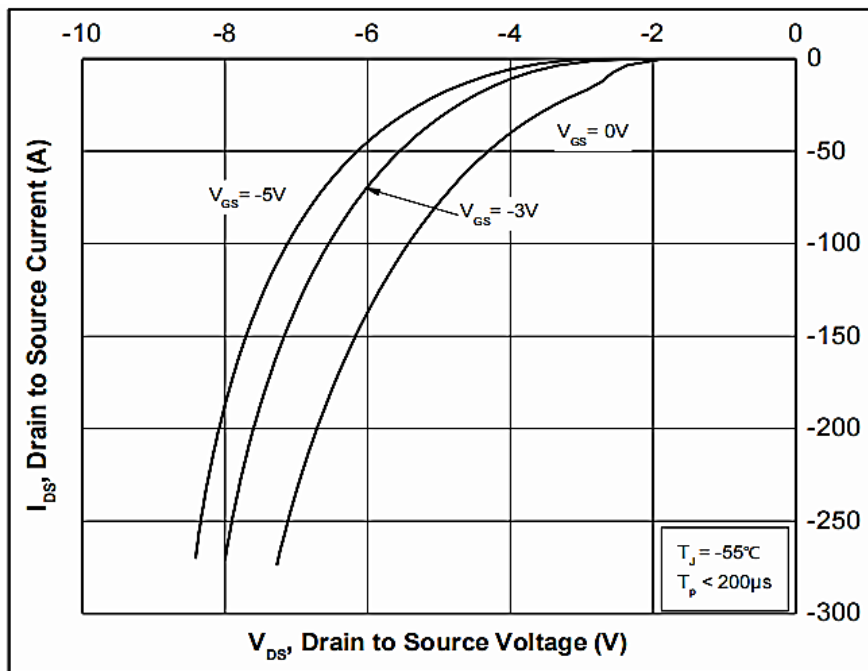

Figure 8. Body Diode Characteristic at  $-55^\circ\text{C}$

**SILICON CARBIDE (SiC) MOSFET TO2474L NC1M SERIES**

**TYPICAL PERFORMANCE-** For Reference Only

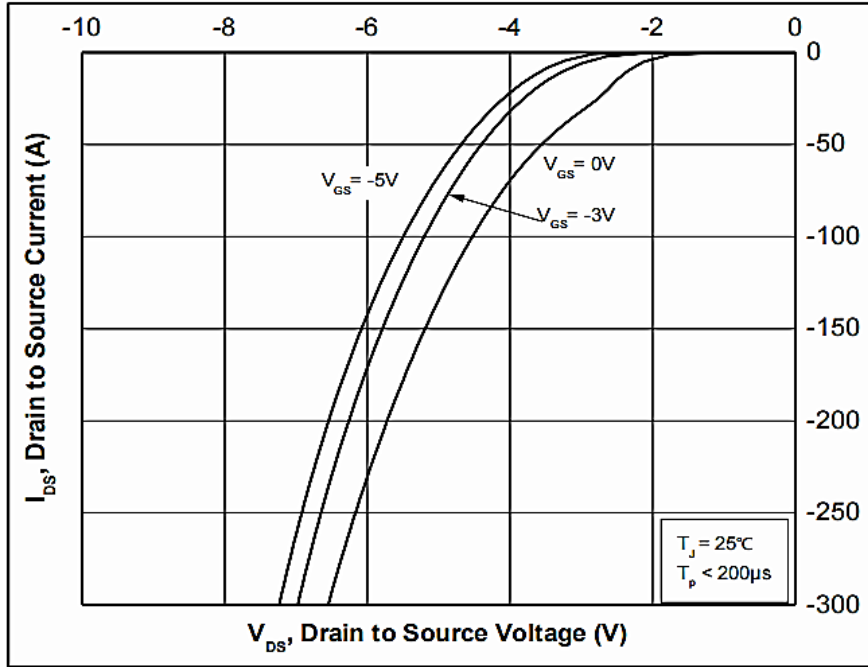

Figure 9. Body Diode Characteristic at 25°C

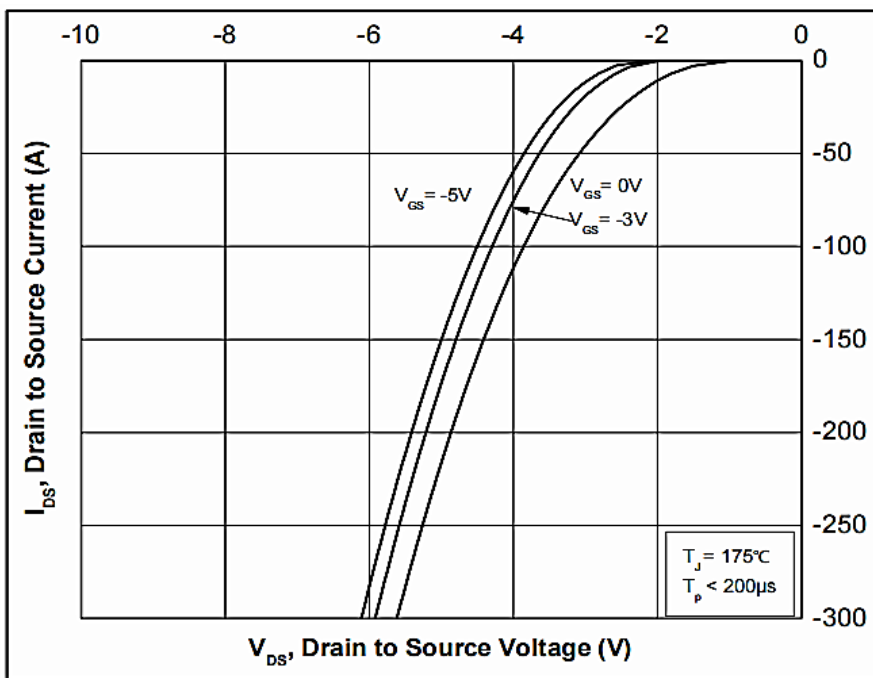

Figure 10. Body Diode Characteristic at 175°C

**SILICON CARBIDE (SiC) MOSFET TO2474L NC1M SERIES**

TYPICAL PERFORMANCE- For Reference Only

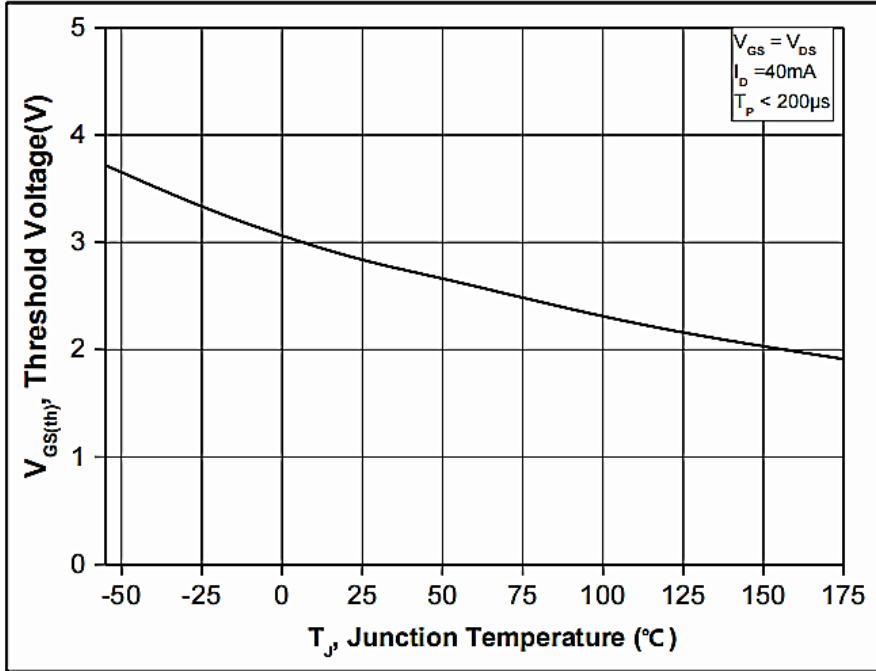

Figure 11. Threshold Voltage vs. Temperature

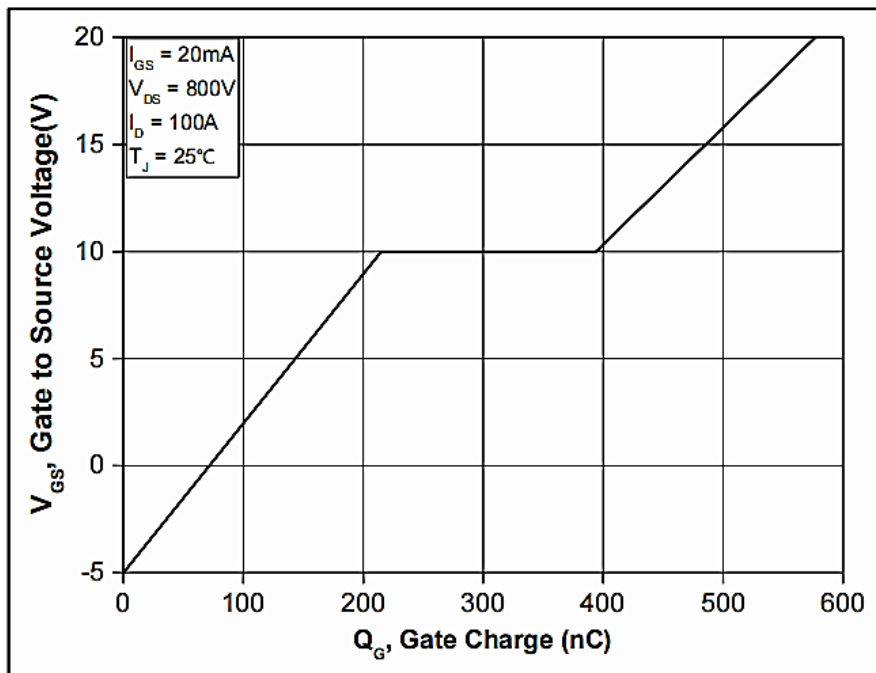

Figure 12. Gate Charge Characteristics

**SILICON CARBIDE (SiC) MOSFET TO2474L NC1M SERIES**

TYPICAL PERFORMANCE - For Reference Only

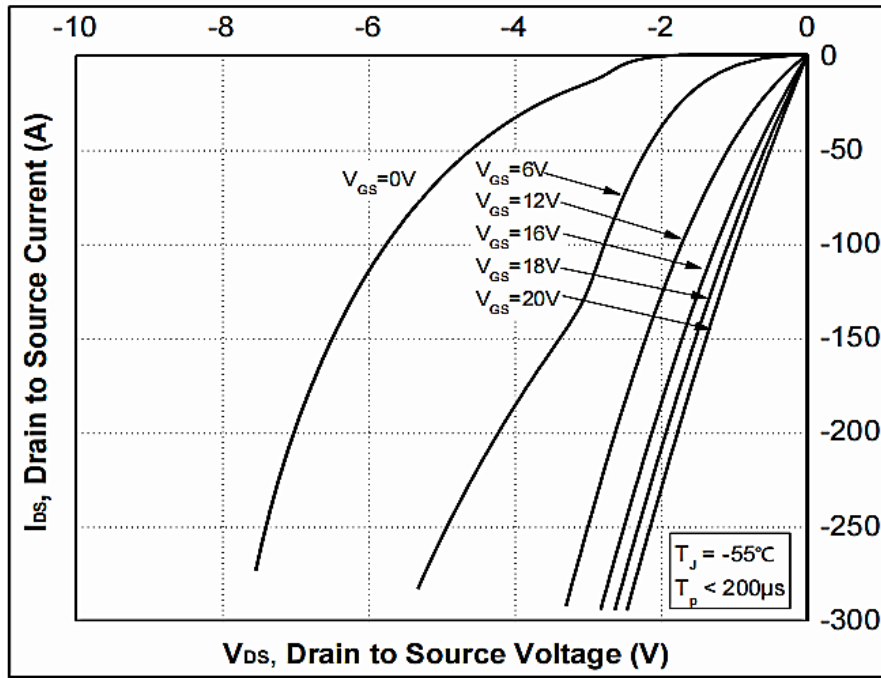

Figure 13. 3<sup>rd</sup> Quadrant Characteristic at  $-55^\circ\text{C}$

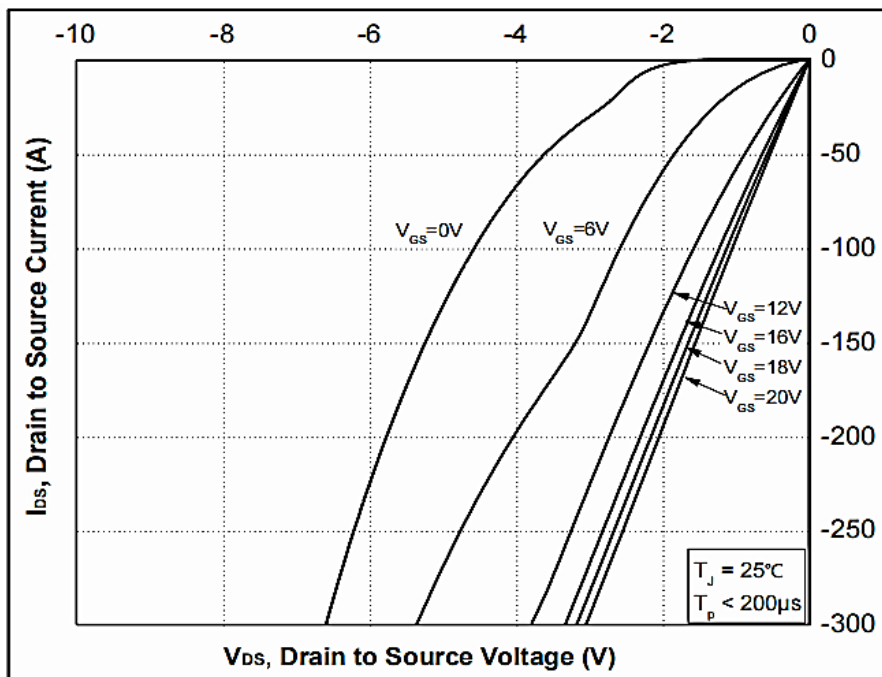

Figure 14. 3<sup>rd</sup> Quadrant Characteristic at  $25^\circ\text{C}$

**SILICON CARBIDE (SiC) MOSFET TO2474L NC1M SERIES**

TYPICAL PERFORMANCE - For Reference Only

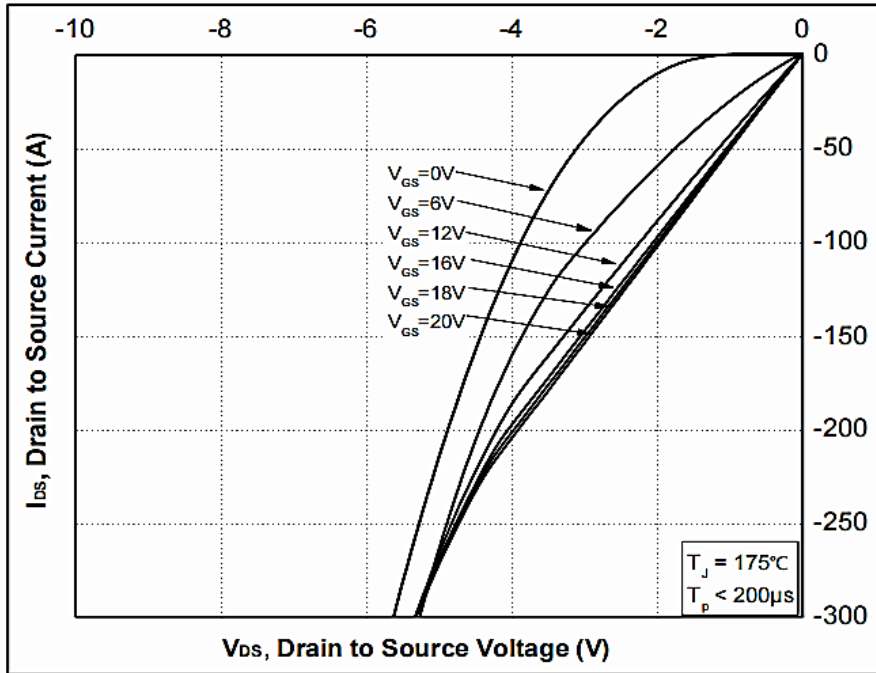

Figure 15. 3<sup>rd</sup> Quadrant Characteristic at 175°C

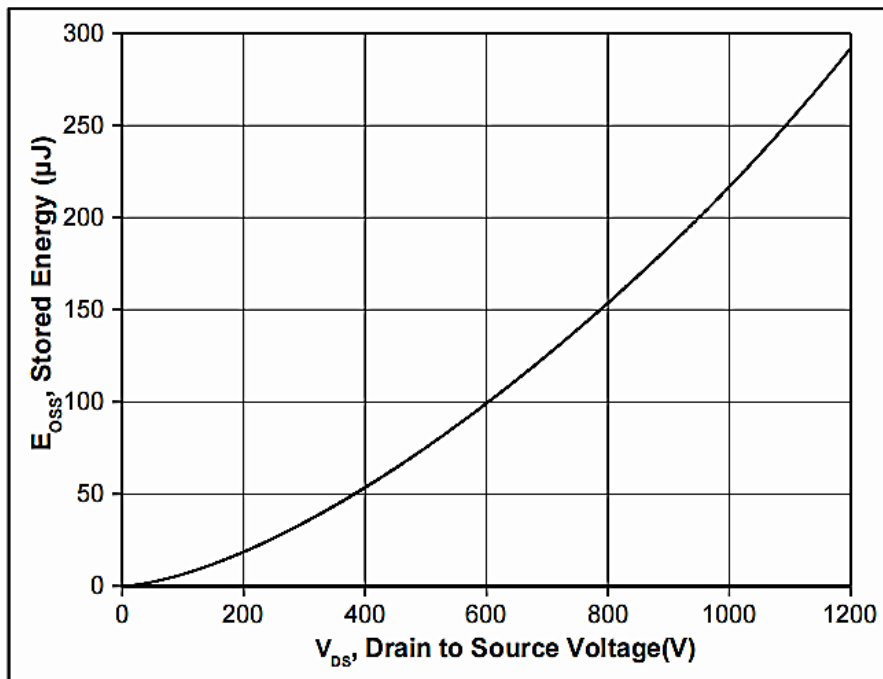

Figure 16. Output Capacitor Stored Energy

**SILICON CARBIDE (SiC) MOSFET TO2474L NC1M SERIES**

TYPICAL PERFORMANCE - For Reference Only

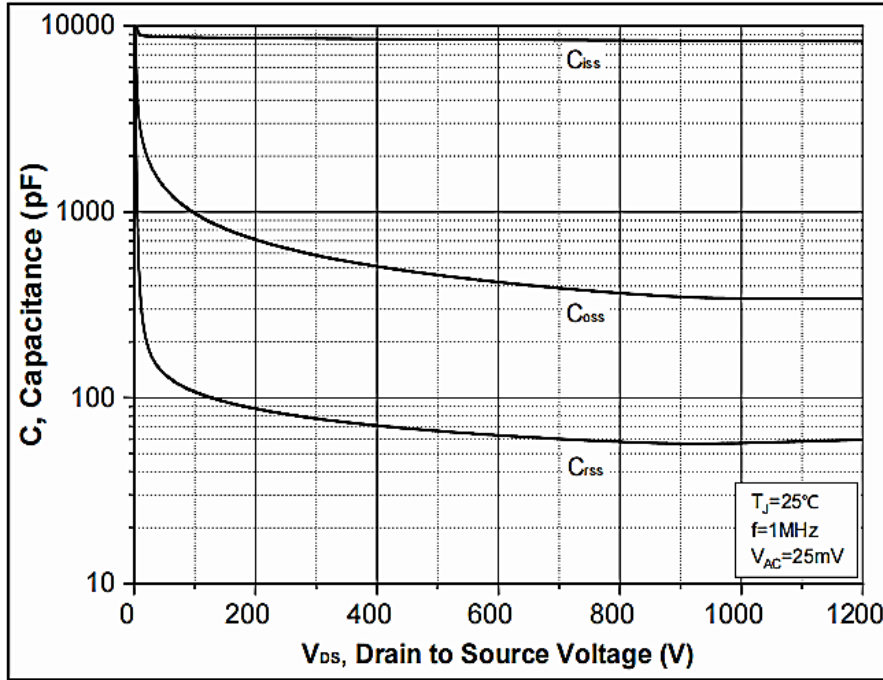

Figure 17. Capacitances vs. Drain-Source Voltage

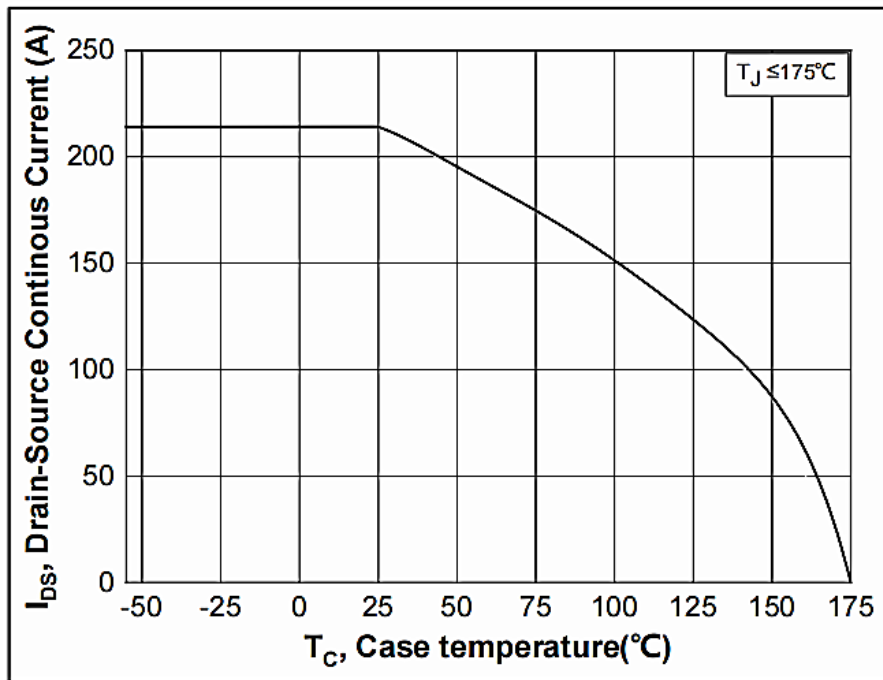

Figure 18. Continuous Drain Current Derating vs. Case Temperature



**SILICON CARBIDE (SiC) MOSFET TO2474L NC1M SERIES**

TYPICAL PERFORMANCE - For Reference Only

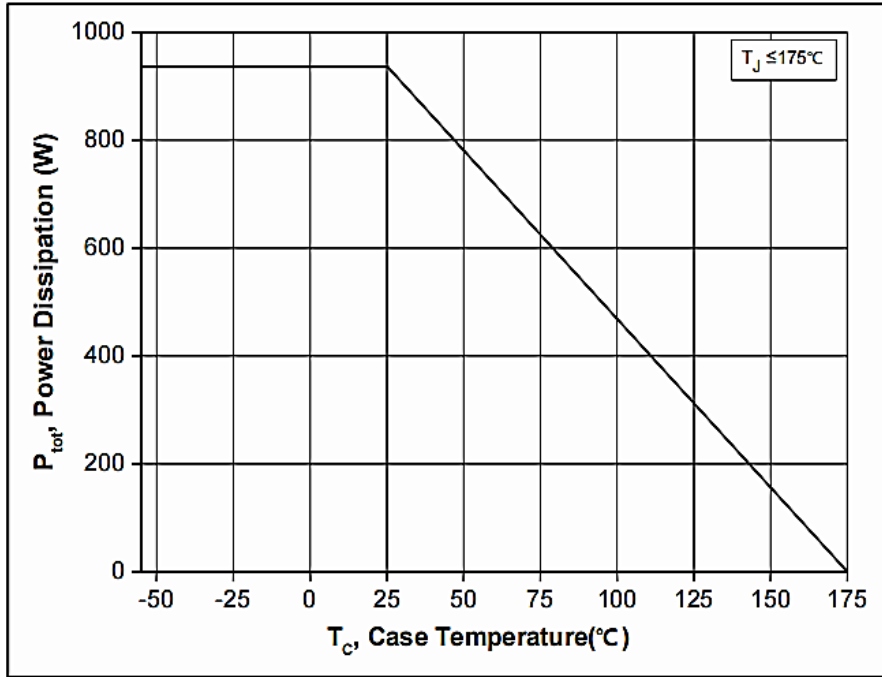

Figure 19. Maximum Power Dissipation Derating vs. Case Temperature

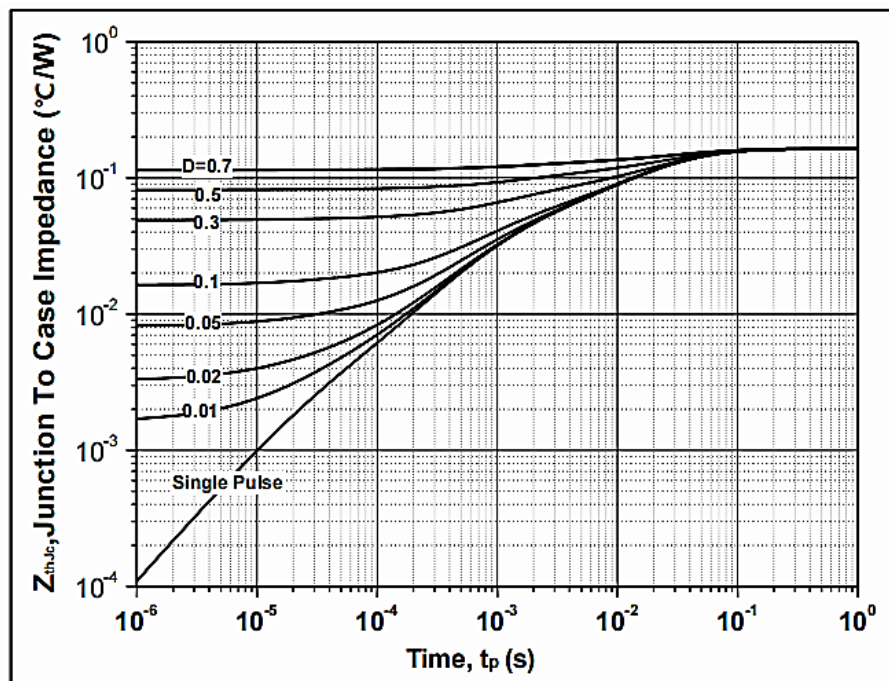

Figure 20. Transient Thermal Impedance (Junction - Case)

**SILICON CARBIDE (SiC) MOSFET TO2474L NC1M SERIES**

TYPICAL PERFORMANCE - For Reference Only

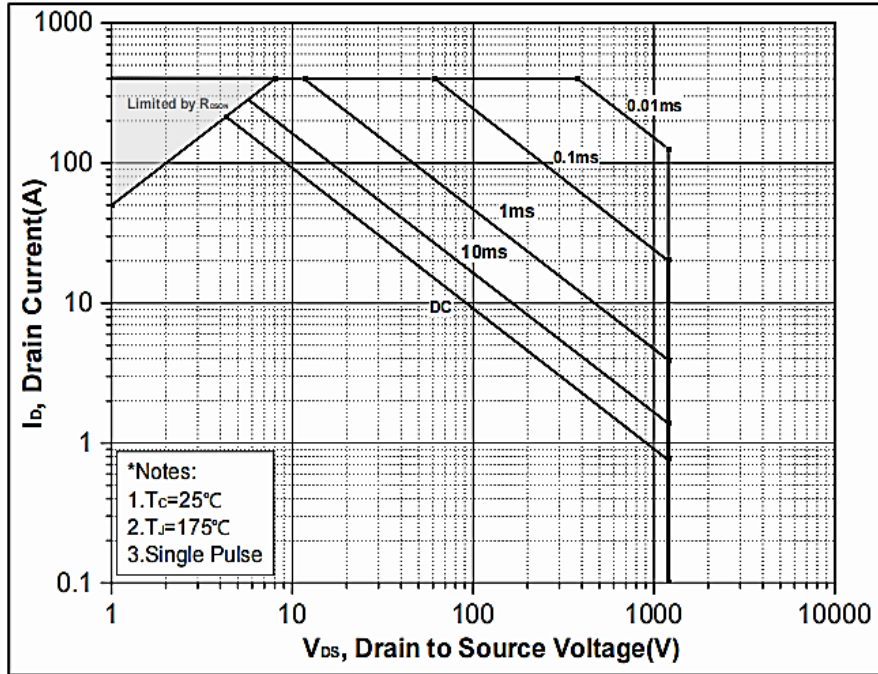

Figure 21. Safe Operating Area

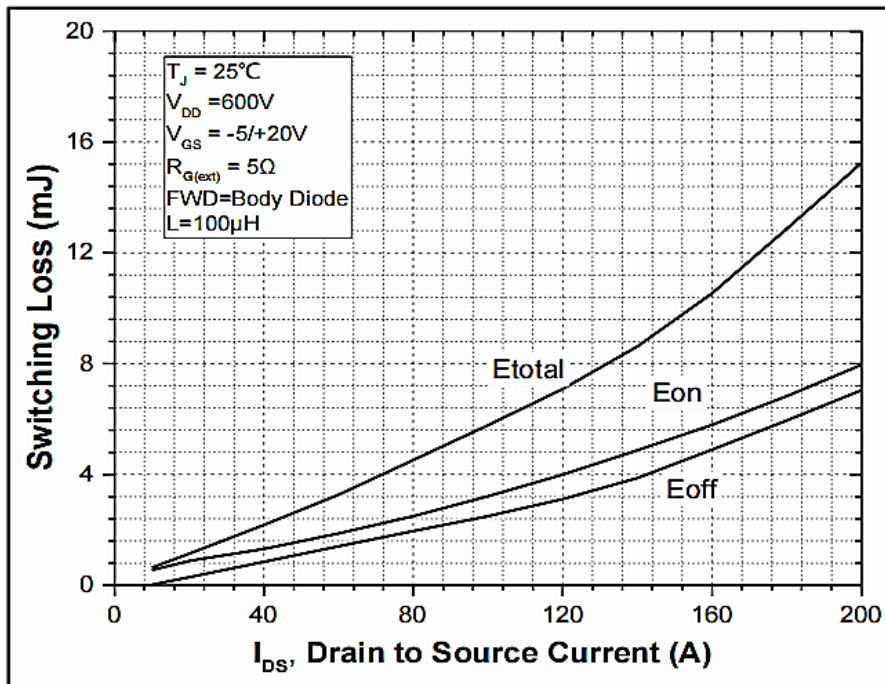

Figure 22. Clamped Inductive Switching Energy vs. Drain Current ( $V_{DD} = 600\text{V}$ )

**SILICON CARBIDE (SiC) MOSFET TO2474L NC1M SERIES**

TYPICAL PERFORMANCE - For Reference Only

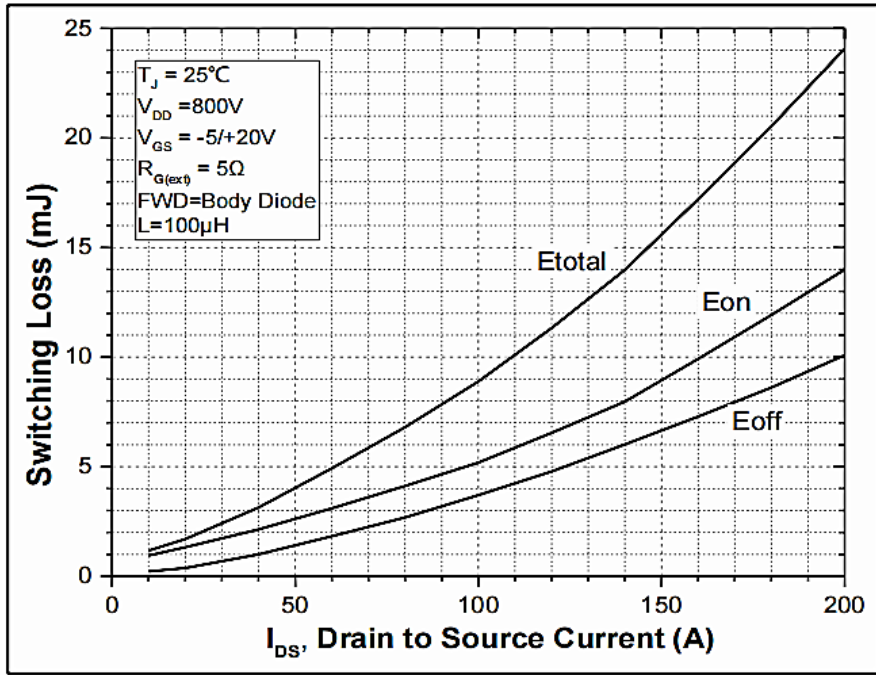

Figure 23. Clamped Inductive Switching Energy vs. Drain Current ( $V_{DD}=800V$ )

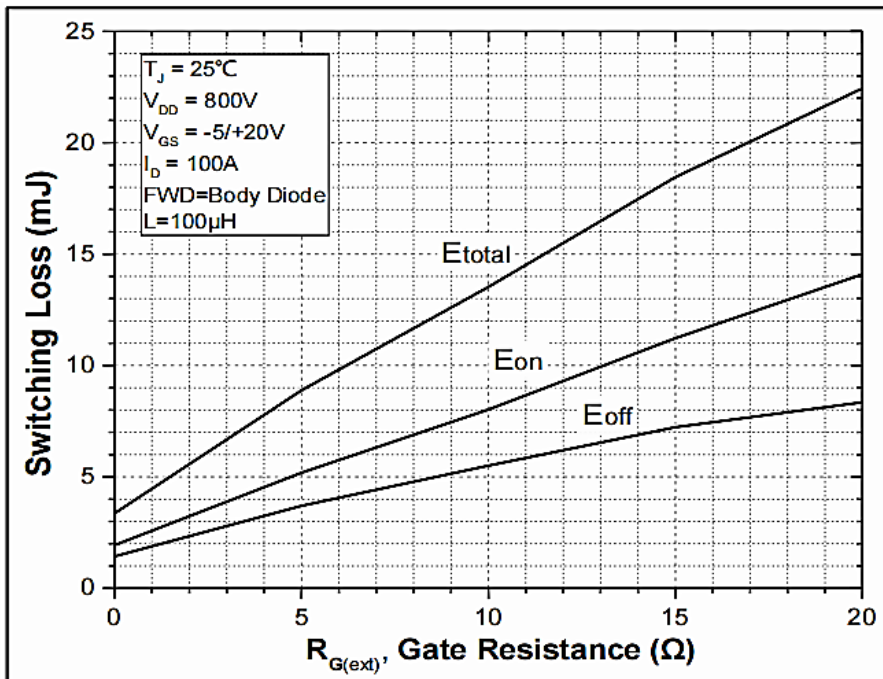

Figure 24. Clamped Inductive Switching Energy vs.  $R_{G(ext)}$

**SILICON CARBIDE (SiC) MOSFET TO2474L NC1M SERIES**

TYPICAL PERFORMANCE - For Reference Only

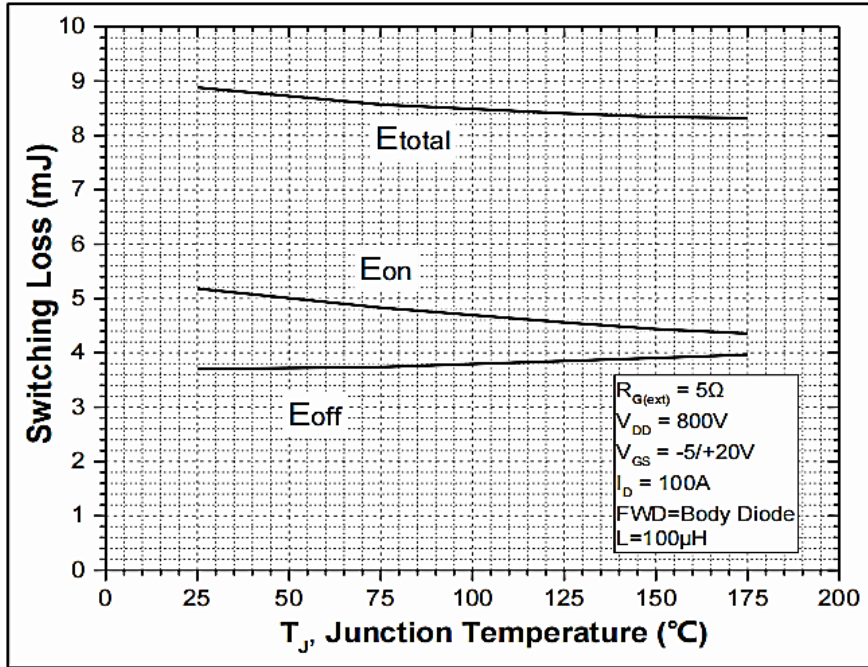

Figure 25. Clamped Inductive Switching Energy vs.  $T_j$

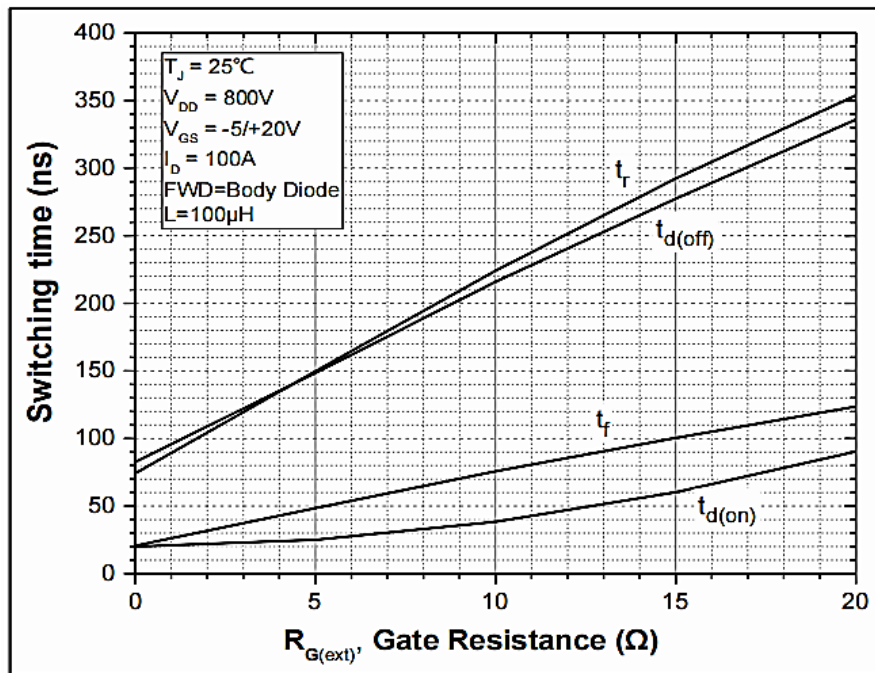

Figure 26. Switching Time vs.  $R_{G(ext)}$

## SILICON CARBIDE (SiC) MOSFET TO2474L NC1M SERIES

### ROHS COMPLIANCE

- The levels of RoHS restricted materials in this product are below the maximum concentration values (also referred to as the threshold limits) permitted for such substances, or are used in an exempted application, in accordance with EU RoHS Directive (EU) 2015/863 EC (RoHS3). RoHS Test Report for this product can be obtained can be obtained at Download Center.

### REACH COMPLIANCE

- REACH substances of high concern (SVHCs) information is available for this product. Since the European Chemical Agency (ECHA) has published notice of their intent to frequently revise the SVHC listing for the foreseeable future, REACH Test Report for this product can be obtained can be obtained at Download Center.

### IMPORTANT NOTES AND DISCLAIMER

- 1) All Product parametric performance is indicated in the Electrical Characteristics for the listed herein test conditions, unless otherwise noted. Product performance may not be indicated by the Electrical Characteristics if operated under different conditions.
- 2) NextGen Component, Inc (*NextGen*) reserves the right to make changes to this document and its products and specifications at any time without notice. Customers should obtain and confirm the latest product information and specifications before final design, purchase or use.
- 3) *NextGen* makes no warranty, representation or guarantee regarding the suitability of its products for any particular purpose, nor does NextGen assume any liability for application assistance or customer product design.
- 4) *NextGen* does not warrant or accept any liability with products which are purchased or used for any unintended or unauthorized application. No license is granted by implication or otherwise under any intellectual property rights of NextGen.
- 5) *NextGen* products are not authorized for use as critical components in life support devices or systems without express written approval by *NextGen*.
- 6) *NextGen* requires that customers first obtain an RMA (Returned Merchandise Authorization) number prior to returning any products. Returns must be made within 30 days of the date of invoice, be in the original packaging, unused and like-new condition. At the time of quoting or purchasing, a product may say that it is Non-Cancelable/ Non-Returnable (NCNR). These products are not returnable and not refundable.