



SPECIFICATION SHEET

SPECIFICATION SHEET NO.	Q1105-MM1W135S000FLX	
DATE	Nov. 05, 2023	
REVISION	A0	Updated With Most Recent Data - Official First Release
DESCRIPTION AND MAIN PARAMETRICS	<p>SMD Zener Diodes, MM1W series, Case SOD-123, 2 Pads MM1W135V Type, Voltage - Zener (Nom) (Vz): 135V, Peak Pulse Power: 1.0 Watts Operating Temp. Range -55°C ~+150°C Package in Tape/Reel, 3000pcs/Reel RoHS III/REACH Compliant and Halogen Free (HF)</p>	
CUSTOMER		
CUSTOMER PART NO.		
CROSS REF. PART NO.		
ORIGINAL MFG/PART NO.	MDD/MM1W135V	
PART CODE	MM1W135S000FLX	

VENDOR APPROVE			
Issued/Checked/Approved			
DATE: Nov. 05, 2023			

CUSTOMER APPROVE	
DATE:	

SMD ZENER DIODES MM1W SERIES

MAIN FEATURE

- Small Plastic Package Suitable For Surface Mounted Design.
- Wide Zener Reverse Voltage Range 3.3V To 330V.
- Glass Passivated Junction
- Tolerance Approximately $\pm 5\%$
- 1.0W Max. Peak Pulse Power
- High Temperature Soldering Guaranteed: 260°C/10 Seconds At Terminals
- REACH/RoHS III Complaint And Halogen Free
- Cross Main Competitor Parts In Market



APPLICATION

- For SMD Application

RFQ

[Request For Quotation](#)

PART CODE GUIDE

MM1W	135V	S	000FLX
1	2	3	4

1. MM1W: SMD Zener SERIES Diodes, Package Case SOD-123, MM1W series Code
2. 135V: Specification code for Voltage - Zener (Nom) (Vz): 135V
3. S: Package code, Tape/Reel
4. 000FLX: Marking code for "FLX" on the case surface, Different Marking for different specification

ELECTRICAL CHARACTERISTICS

See Page 5 ~ Page 7 For Different Part Code

HOW TO ORDER

Please indicate part code and send us your RFQ by E-mail, sales@nextgencomponent.com

SMD ZENER DIODES MM1W SERIES

DIMENSION - Unit: Inch/mm

Image for reference



Marking: Standard

- See Marking Code
- List at Page 5~ Page 7

Case Dimensic

SOD-123

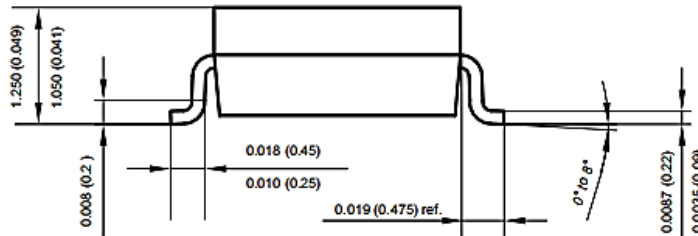
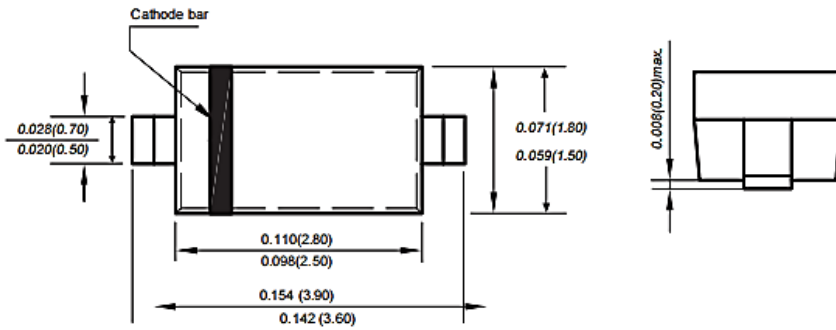

Recommend Pad Layout

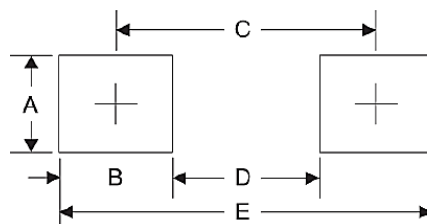

Symbol	Unit (Inch)	Unit (mm)
A	0.047	1.20
B	0.047	1.20
C	0.126	3.20
D	0.079	2.00
E	0.173	4.40

SMD ZENER DIODES MM1W SERIES

MECHANICAL DATA

Case	Terminals	Polarity	Mounting Position	Marking	Weight per piece
JEDEC SOD-123 molded plastic body	Solderable per MIL-STD-750, Method 2026	Polarity symbol marking on body	ANY	See Marking Code List (Page 5~Page 7)	0.00056 ounce 0.016 grams

MAX. RATING & CHARACTERISTICS - Ratings at 25°C Ambient Temperature Unless Otherwise Specified.

Parameter	SYMBOLS	VALUE	UNITS
Forward Voltage @ I _{FSM} =10mA	V _F	1.2	V
Peak Pulse Power Dissipation	P _D	1.0	W
Typical Thermal Resistance Junction To Ambient (Note 1)	R _{θJA}	300	°C/W
Peak Forward Surge Current	I _{FSM}	10.0	mA
Operating Junction Temperature Range	T _J	-55 ~ +150	°C
Storage Temperature Range	T _{stg}	-55 ~ +150	°C

Notes

1. Thermal resistance from junction to ambient at P.C.B. mounted with 2.0" X 2.0" (5 X 5 cm) copper areas pads.

SMD ZENER DIODES MM1W SERIES
ELECTRICAL CHARACTERISTICS UNIDIRECTIONAL TYPE - Ta = 25°C

Part Code	Zener Voltage Range (See Note 1) V _{ZT} @ I _{ZT} (V)			Test Current I _{ZT} (mA)	Dynamic Impedance Max. Z _{DT} @ I _{ZT} (Ω)	Reverse Current		Admissible Zener Current I _{ZM} (mA)	Marking Code
	Min.	Nom	Max.			Max. I _R (μA)	@ V _R (V)		
MM1W3V3S000FHD	3.1	3.3	3.5	75	10	100	1	285	FHD
MM1W3V6S000FHE	3.4	3.6	3.8	69	10	100	1	263	FHE
MM1W3V9S000FHF	3.7	3.9	4.1	64	9	50	1	243	FHF
MM1W4V3S000FHG	4.06	4.3	4.56	58	9	25	1	219	FHG
MM1W4V7S000FHJ	4.5	4.7	4.93	53	8	10	1	203	FHJ
MM1W5V1S000FHK	4.84	5.1	5.36	49	7	10	1	186	FHK
MM1W5V6S000FHL	5.32	5.6	5.92	45	5	10	2	170	FHL
MM1W6V2S000FHN	5.86	6.2	6.51	41	2	10	3	154	FHN
MM1W6V8S000FHO	6.46	6.8	7.18	37	3.5	10	4	140	FHO
MM1W7V5S000FHQ	7.12	7.5	7.88	34	4	10	5	127	FHQ
MM1W8V2S000FHR	7.79	8.2	8.67	31	4.5	10	6	116	FHR
MM1W9V1S000FHT	8.6	9.1	9.59	28	5	10	7	104	FHT
MM1W10S0000FHU	9.5	10	10.5	25	7	10	7	95	FHU
MM1W11S0000FHV	10.4	11	11.6	23	8	5	8	86	FHV
MM1W12S0000FHW	11.4	12	12.6	21	9	5	9	79	FHW
MM1W13S0000FHX	12.4	13	14.1	19	10	5	10	71	FHX
MM1W15S0000FHZ	13.8	15	15.8	17	14	5	11	63	FHZ
MM1W16S0000FJA	15.2	16	17.1	16	16	5	12	58	FJA
MM1W18S0000FJF	16.8	18	19.2	14	20	5	13	52	FJF
MM1W20S0000FJG	19	20	21.2	13	22	5	15	47	FJG
MM1W22S0000FJK	20.8	22	23.3	12	23	5	17	43	FJK

SMD ZENER DIODES MM1W SERIES
ELECTRICAL CHARACTERISTICS UNIDIRECTIONAL TYPE - Ta = 25°C

Part Code	Zener Voltage Range (See Note 1) V _{ZT} @ I _{ZT} (V)			Test Current I _{ZT} (mA)	Dynamic Impedance Max. Z _{ZT} @ I _{ZT} (Ω)	Reverse Current		Admissible Zener Current I _{ZM} (mA)	Marking Code
	Min.	Nom	Max.			Max. I _R (μA)	@ V _R (V)		
MM1W24S0000FJL	22.8	24	26	11	25	5	18	38	FJL
MM1W27S0000FJN	25.3	27	28.9	9.5	35	5	21	35	FJN
MM1W30S0000FJQ	28.2	30	32	8.5	40	5	23	31	FJQ
MM1W33S0000FJR	31.3	33	34.9	7.5	45	5	25	28	FJR
MM1W36S0000FJS	34.2	36	37.9	7	50	5	27	26	FJS
MM1W39S0000FJT	37.2	39	41.5	6.5	60	5	30	24	FJT
MM1W43S0000FLG	40.9	43	45.6	6	70	1	32	22	FLG
MM1W47S0000FLJ	44.9	47	49.8	5.5	80	1	35	20	FLJ
MM1W51S0000FLK	48.6	51	54	5	95	1	38	18	FLK
MM1W56S0000FLL	53.6	56	58.8	4.5	110	1	42	17	FLL
MM1W62S0000FLN	58.9	62	65.6	4	125	1	47	15	FLN
MM1W68S0000FLO	64.6	68	71.7	3.7	150	1	52	14	FLO
MM1W75S0000FLQ	71.2	75	78.8	3.3	175	1	56	12	FLQ
MM1W82S0000FLR	77.9	82	87	3	200	1	62	11	FLR
MM1W91S0000FLT	86	91	96	2.8	250	1	69	10	FLT
MM1W100S000FLU	95	100	105	2.5	350	1	76	9.5	FLU
MM1W110S000FLV	104	110	116	2.3	450	1	84	8.6	FLV
MM1W120S000FLW	114	120	127	2	550	1	91	7.8	FLW
MM1W135S000FLX	125	135	142	1.9	700	1	100	7	FLX
MM1W150S000FLZ	140	150	157	1.7	900	1	110	6.3	FLZ
MM1W165S000FPA	155	165	172	1.6	1100	1	120	5.8	FPA

SMD ZENER DIODES MM1W SERIES

ELECTRICAL CHARACTERISTICS UNIDIRECTIONAL TYPE - Ta = 25°C

Part Code	Zener Voltage Range (See Note 1) V _{ZT} @ I _{ZT} (V)			Test Current I _{ZT} (mA)	Dynamic Impedance Max. Z _{DT} @ I _{ZT} (Ω)	Reverse Current		Admissible Zener Current I _{ZM} (mA)	Marking Code
	Min.	Nom	Max.			Max. I _R (μA)	@ V _R (V)		
MM1W180S000FPF	170	180	191	1.4	1200	1	135	5.2	FPF
MM1W200S000FPG	189	200	211	1.2	1400	1	150	4.7	FPG
MM1W220S000FPK	209	220	231	1	1600	1	165	4.3	FPK
MM1W240S000FPL	229	240	251	1	1800	1	180	3.9	FPL
MM1W260S000FPM	249	260	271	1	2000	1	190	3.7	FPM
MM1W280S000FPN	269	280	291	1	2100	1	205	3.4	FPN
MM1W300S000FPQ	289	300	315	1	2300	1	230	3.1	FPQ
MM1W330S000FPR	313	330	346	1	2500	1	250	2.8	FPR

Notes 1: V_{ZT} is tested with pulses (20 ms)

RATINGS AND CHARACTERISTIC CURVES (For Reference Only) - $T_a = 25^\circ\text{C}$ Unless Otherwise Specified

Figure 1. Maximum Continuous Power Derating Curve

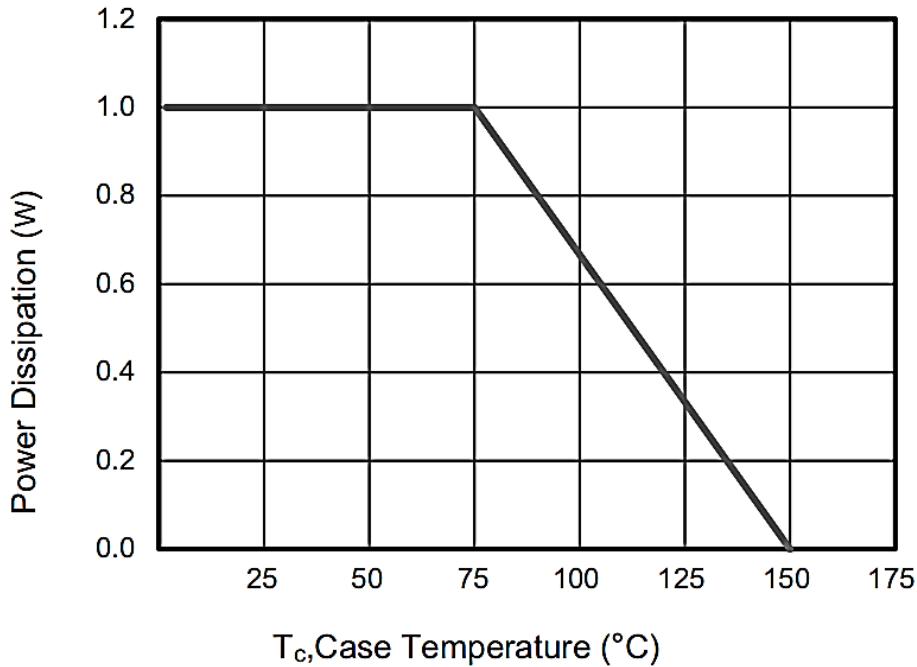
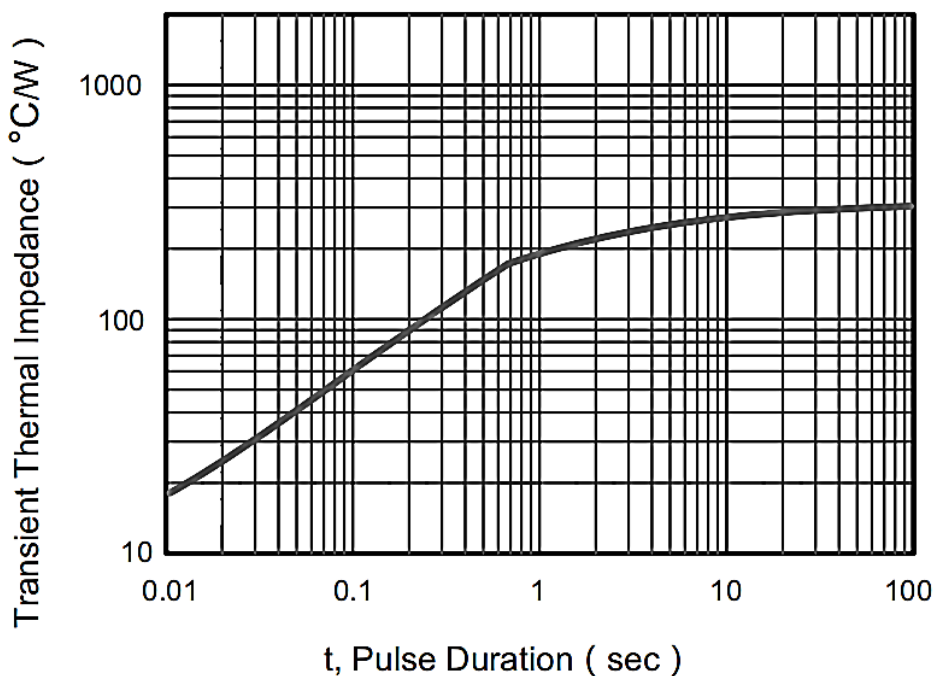

Figure 2. Typical Transient Thermal Impedance Curve



SMD ZENER DIODES MM1W SERIES
RELIABILITY

Number	Experiment Items	Experiment Method And Conditions	Reference Documents
1	Solder Resistance Test	Test 260°C± 5°C for 10 ± 2 sec. Immerse body into solder 1/16" ± 1/32"	MIL-STD-750D METHOD-2031.2
2	Solderability Test	230°C ±5°C for 5 sec.	MIL-STD-750D METHOD-2026.1 0
3	Pull Test	1 kg in axial lead direction for 10 sec.	MIL-STD-750D METHOD-2036.4
4	Bend Test	0.5Kg Weight Applied To Each Lead, Bending Arcs 90 °C ± 5 °C For 3 Times	MIL-STD-750D METHOD-2036.4
5	High Temperature Reverse Bias Test	TA=100°C for 1000 Hours at VR=80% Rated VR	MIL-STD-750D METHOD-1038.4
6	Forward Operation Life Test	TA=25°C Rated Average Rectified Current	MIL-STD-750D METHOD-1027.3
7	Intermittent Operation Life Test	On state: 5 min with rated IRMS Power Off state: 5 min with Cool Forced Air. On and off for 1000 cycles.	MIL-STD-750D METHOD-1036.3
8	Pressure Cooker Test	15 PSIG, TA=121°C, 4 hours	MIL-S-19500 APPENOIXC
9	Temperature Cycling Test	-55°C~+125°C; 30 Minutes For Dwelled Time 5 minutes for transferred time. Total: 10 cycles.	MIL-STD-750D METHOD-1051.7
10	Thermal Shock Test	0°C for 5 minutes., 100°C for 5minutes, Total: 10 cycles	MIL-STD-750D METHOD-1056.7
11	Forward Surge Test	8.3ms Single Sale Sine-wave One Surge.	MIL-STD-750D METHOD-4066.4
12	Humidity Test	TA=65°C, RH=98% for 1000 hours.	MIL-STD-750D METHOD-1021.3
13	High Temperature Storage life Test	150°C for 1000 Hours	MIL-STD-750D METHOD-1031.5

SUGGESTED REFLOW PROFILE - For Reference Only

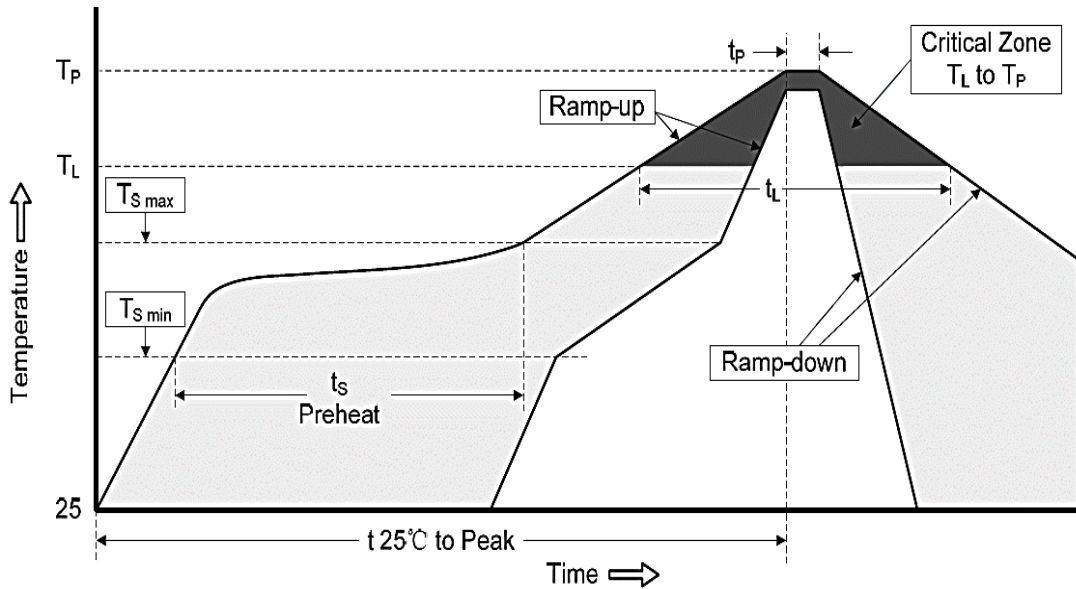

Profile Feature		Pb-Free Assembly
Average Ramp-up Rate (Ts Max to Tp)		3°C/second Max
Preheat	Temperature Min (Ts Min.)	150°C
	Temperature Max (Ts Max.)	200°C
	Time (ts Min. to ts Max.)	60 ~ 180 seconds
Time maintained above	Temperature (Tl)	217°C
	Time (tl)	60 ~ 150 seconds
Peak/Classification Temperature (Tp)		260 °C
Time within 5°C of actual Peak Temperature (tp)		20 ~ 40 seconds
Ramp-down rate		6 °C /Second Max.
Time 25 °C to Peak Temperature		8 minutes Max.
Suggest reflow times		3 Times Max.

SMD ZENER DIODES MM1W SERIES

TAPE/REEL (Unit: mm)

All Devices are packed in accordance with EIA standard RS-481-A and Tape 12mm, Component Spacing 4.0mm

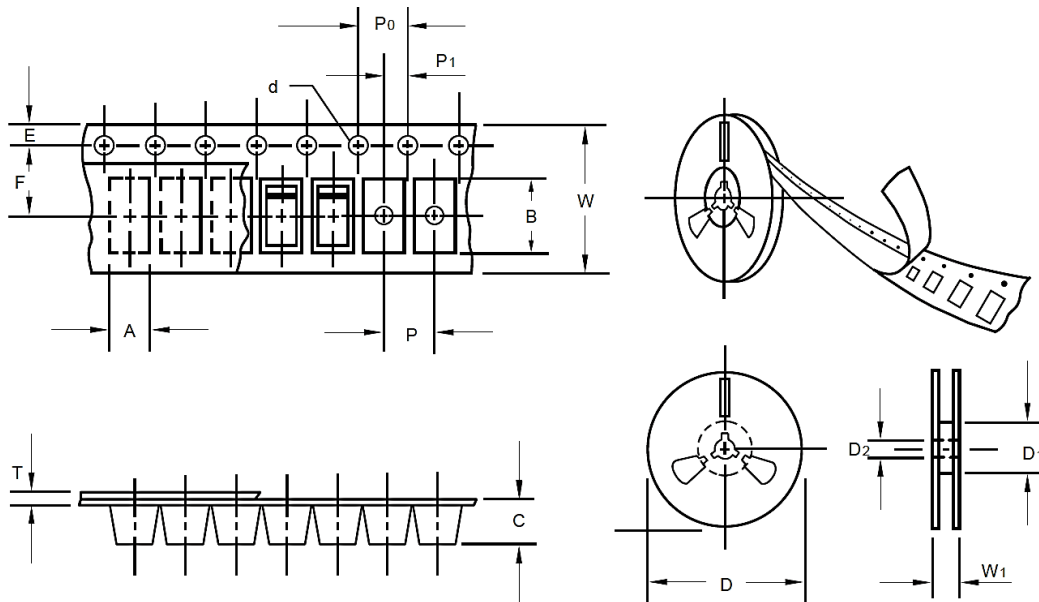

Item	Symbol	Tolerance	Case SOD-123
Carrier width	A	0.1	2.10
Carrier Length	B	0.1	4.00
Carrier Depth	C	0.1	1.60
Sprocket hole	d	0.05	1.55
13"Reel outside diameter	-	-	-
13"Reel inner diameter	-	-	-
7"Reel outside diameter	D	2.0	178.00
7"Reel inner diameter	D1	Min.	50.00
Feed hole diameter	D2	0.5	13.00
Sprocket hole position	E	0.1	1.75
Punch hole position	F	0.1	3.50
Punch hole pitch	P	0.1	4.00
Sprocket hole pitch	P0	0.1	4.00
Embossment center	P1	0.1	2.00
Overall tape thickness	T	0.1	0.25
Tape width	W	0.3	8.15
Reel width	W1	1.0	10.50

ROHS COMPLIANCE

- The levels of RoHS restricted materials in this product are below the maximum concentration values (also referred to as the threshold limits) permitted for such substances, or are used in an exempted application, in accordance with EU RoHS Directive (EU) 2015/863 EC (RoHS3). RoHS Test Report for this product can be obtained can be obtained at Download Center.

REACH COMPLIANCE

- REACH substances of high concern (SVHCs) information is available for this product. Since the European Chemical Agency (ECHA) has published notice of their intent to frequently revise the SVHC listing for the foreseeable future, REACH Test Report for this product can be obtained can be obtained at Download Center.

IMPORTANT NOTES AND DISCLAIMER

1. All Product parametric performance is indicated in the Electrical Characteristics for the listed herein test conditions, unless otherwise noted. Product performance may not be indicated by the Electrical Characteristics if operated under different conditions.
2. NextGen Component, Inc (*NextGen*) reserves the right to make changes to this document and its products and specifications at any time without notice. Customers should obtain and confirm the latest product information and specifications before final design, purchase or use.
3. *NextGen* makes no warranty, representation or guarantee regarding the suitability of its products for any particular purpose, nor does NextGen assume any liability for application assistance or customer product design.
4. *NextGen* does not warrant or accept any liability with products which are purchased or used for any unintended or unauthorized application. No license is granted by implication or otherwise under any intellectual property rights of NextGen.
5. *NextGen* products are not authorized for use as critical components in life support devices or systems without express written approval by *NextGen*.
6. *NextGen* requires that customers first obtain an RMA (Returned Merchandise Authorization) number prior to returning any products. Returns must be made within 30 days of the date of invoice, be in the original packaging, unused and like-new condition. At the time of quoting or purchasing, a product may say that it is Non-Cancelable/ Non-Returnable (NCNR). These products are not returnable and not refundable.