



**SPECIFICATION SHEET**

<b>SPECIFICATION SHEET NO.</b>	N0310-R610A10000AA0A
<b>DATE</b>	Mar. 10, 2021
<b>REVISION</b>	A0
<b>DESCRIPTION</b>	<p>Axial Lead General Purpose Silicon Rectifier, R-6 series, 10A10 Type 2 Pins            Reverse Voltage 1000V Max. Forward Current 10.0A Max.            Operating Temp. Range -55°C ~+150°C            Package in AMMO Pack, 5000pcs/Tape, Tape/Box            RoHS/RoHS III compliant</p>
<b>CUSTOMER</b>	
<b>CUSTOMER PART NUMBER</b>	
<b>CROSS REF. PART NUMBER</b>	
<b>ORIGINAL PART NUMBER</b>	MDD 10A10 – T/B
<b>PART CODE</b>	R610A10000AA0A

<b>VENDOR APPROVE</b>			
Issued/Checked/Approved			
DATE: March 10, 2021			

<b>CUSTOMER APPROVE</b>	
DATE:	

## GENERAL PURPOSE SILICON RECTIFIER R6 SERIES

### MAIN FEATURE

- The plastic package carries Underwriters Laboratory Flammability Classification 94V-0
- Fast switching for high efficiency
- High forward surge current capability
- High temperature soldering guaranteed, 250 °C/10 seconds at terminals
- Low reverse leakage



### APPLICATION

- For printed circuit board

### PART CODE GUIDE

**RFQ**

[Request For Quotation](#)

R6	10A10000	A	A0A
1	2	3	4

1) **R6**: Axial Lead General Purpose Silicon Rectifier, 2 Pins, R-6 series

2) **10A10000**: Type code for original part number 10A10-T/B

3) **A**: Package code, Package in AMMO Pack, 5000pcs/Tape, Tape/Box

4) **A0A**: Specification code for Reverse Voltage 1000V Max. Forward Current 10.0A Max.

### MORE ITEMS AVAILABLE

R66A050000A605	R66A010000A610	R66A020000A620	R66A040000A640	R66A060000A660
R66A080000A680	R66A100000A60A			
R68A050000A805	R68A010000A810	R68A020000A820	R68A040000A840	R68A060000A860
R68A080000A880	R68A100000A80A			
R610A05000AA05	R610A01000AA10	R610A02000AA20	R610A04000AA40	R610A06000AA60
R610A08000AA80	<b>R610A10000AA0A</b>			

**GENERAL PURPOSE SILICON RECTIFIER R6 SERIES**

**DIMENSION (Unit: Inch/mm)**

Image for reference



Marking: 10A10

R-6

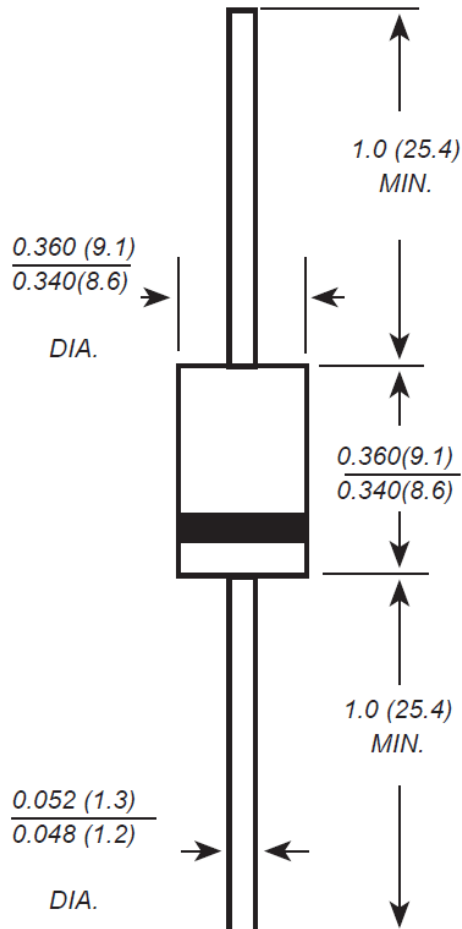

## GENERAL PURPOSE SILICON RECTIFIER R6 SERIES

### MECHANICAL DATA

Case	Terminals	Polarity	Mounting Position	Weight per piece
JEDEC R-6 molded plastic body	Solder plated, Solderable per MIL-STD-750, Method 2026	Polarity symbol marking on case	Any	0.072 Ounce, 2.239 grams

### MAX. RATING & CHARACTERISTICS

Parameter	SYMBOLS	VALUE			UNITS
		Min.	Typical	Max.	
<b>Repetitive peak reverse voltage</b>	V <sub>RRM</sub>			1000	Volts
<b>RMS voltage</b>	V <sub>RMS</sub>			700	Volts
<b>DC blocking voltage</b>	V <sub>DC</sub>			1000	Volts
<b>Average forward output rectified current at TL= 60°C</b>	I <sub>AV</sub>			10.0	A
<b>Peak forward surge current 8.3ms single half sine-wave superimposed on rated load (JEDEC Method)</b>	I <sub>FSM</sub>		600		A
<b>Instantaneous forward voltage at 10.0A</b>	V <sub>F</sub>			1.0	Volts
<b>DC reverse current at rated DC blocking voltage</b>	I <sub>R</sub>			10	μA
				100	μA
<b>Junction capacitance (Note 2)</b>	C <sub>J</sub>		150		pF
<b>Thermal resistance (Note 3)</b>	R <sub>QJA</sub>		10		°C/W
<b>Operating junction temperature range</b>	T <sub>J</sub>	-50		+150	°C
<b>Storage temperature range</b>	T <sub>STG</sub>	-50		+150	°C

Note

- Ratings at 25 C ambient temperature unless otherwise specified. Single phase half-wave 60Hz, resistive or inductive load, for capacitive load current derate by 20%.
- Measured at 1.0MHz and applied reverse voltage of 4.0Voltage
- Thermal resistance from junction to ambient at 0.375"(9.5mm)lead length, PCB. Mounted.

**GENERAL PURPOSE SILICON RECTIFIER R6 SERIES**
**RELIABILITY**

Number	Experiment Items	Experiment Method And Conditions	Reference Documents
1	Solder Resistance Test	Test 260°C± 5°C for 10 ± 2 sec. Immerse body into solder 1/16" ± 1/32"	MIL-STD-750D METHOD-2031.2
2	Solderability Test	230°C ±5°C for 5 sec.	MIL-STD-750D METHOD-2026.1 0
3	Pull Test	1 kg in axial lead direction for 10 sec.	MIL-STD-750D METHOD-2036.4
4	Bend Test	0.5Kg Weight Applied To Each Lead, Bending Arcs 90 °C ± 5 °C For 3 Times	MIL-STD-750D METHOD-2036.4
5	High Temperature Reverse Bias Test	TA=100°C for 1000 Hours at VR=80% Rated VR	MIL-STD-750D METHOD-1038.4
6	Forward Operation Life Test	TA=25°C Rated Average Rectified Current	MIL-STD-750D METHOD-1027.3
7	Intermittent Operation Life Test	On state: 5 min with rated IRMS Power Off state: 5 min with Cool Forced Air. On and off for 1000 cycles.	MIL-STD-750D METHOD-1036.3
8	Pressure Cooker Test	15 PSIG, TA=121°C, 4 hours	MIL-S-19500 APPENOIXC
9	Temperature Cycling Test	-55°C~+125°C; 30 Minutes For Dwelled Time 5 minutes for transferred time. Total: 10 cycles.	MIL-STD-750D METHOD-1051.7
10	Thermal Shock Test	0°C for 5 minutes., 100°C for 5minutes, Total: 10 cycles	MIL-STD-750D METHOD-1056.7
11	Forward Surge Test	8.3ms Single Sale Sine-wave One Surge.	MIL-STD-750D METHOD-4066.4
12	Humidity Test	TA=65°C, RH=98% for 1000 hours.	MIL-STD-750D METHOD-1021.3
13	High Temperature Storage life Test	150°C for 1000 Hours	MIL-STD-750D METHOD-1031.5

**GENERAL PURPOSE SILICON RECTIFIER R6 SERIES**

**RATINGS AND CHARACTERISTIC CURVES (For Reference Only)**

FIG. 1 -- TYPICAL FORWARD CHARACTERISTIC

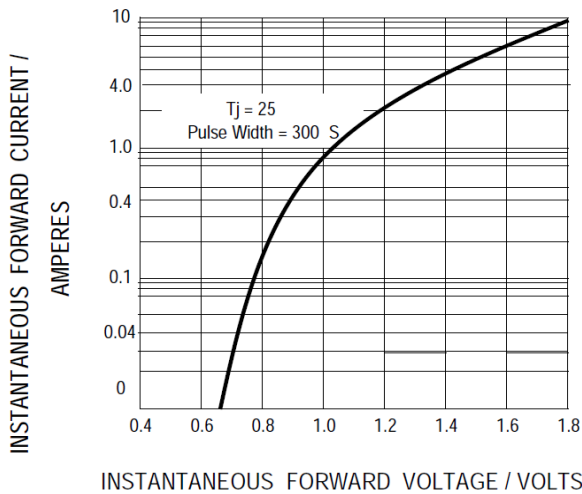

FIG. 2 -- TYPICAL JUNCTION CAPACITANCE

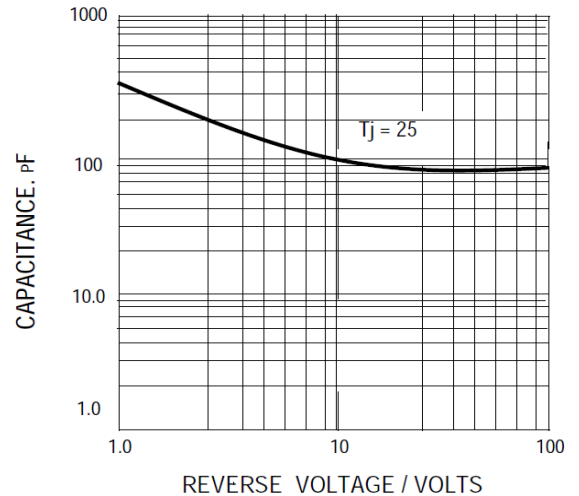

FIG. 3 -- FORWARD CURRENT DERATING CURVE

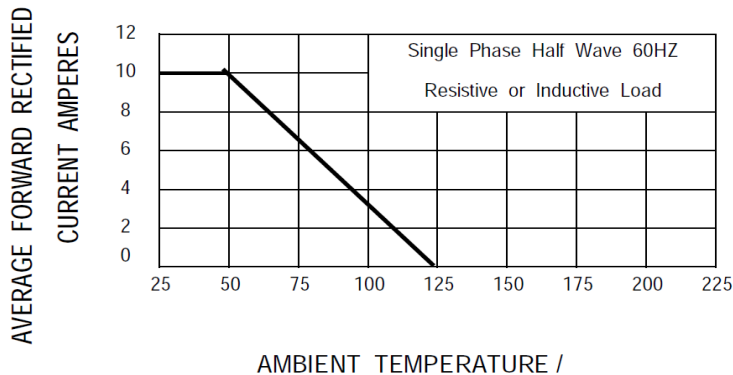
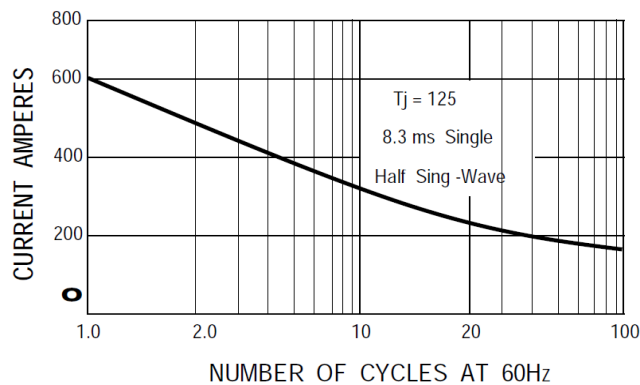

FIG. 4 -- PEAK FORWARD SURGE CURRENT



## GENERAL PURPOSE SILICON RECTIFIER R6 SERIES

### AMMO BOX (Unit: mm)

- All Devices are packed in accordance with EIA standard RS-296-D and specifications.
- Each component lead shall be sandwiched between taps for A minimum of 3.2 mm (0.126")

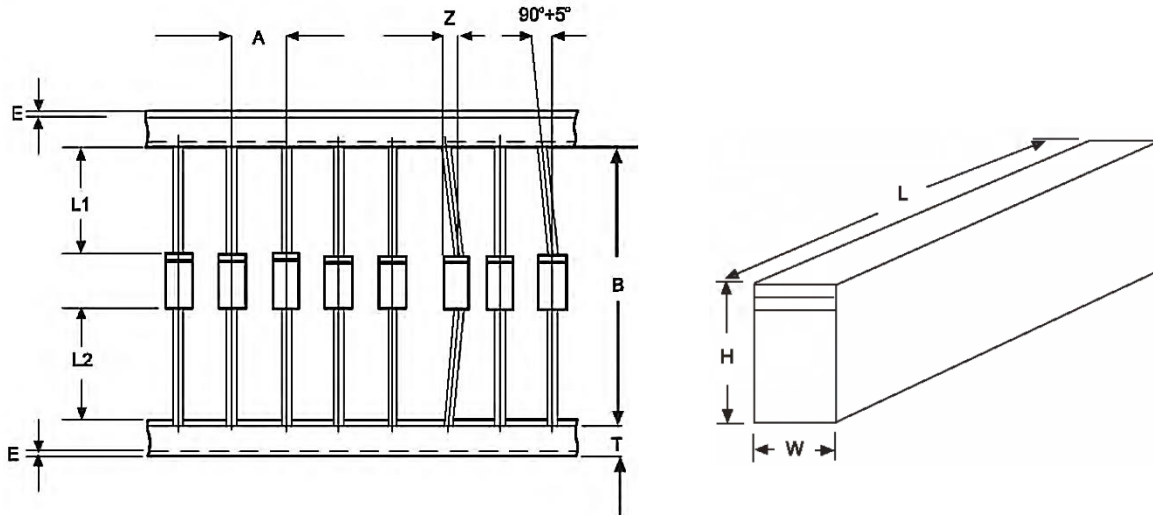

Item	Symbol	R-6 Uni(mm)	R-6 Unit (Inch)
Component Alignment	Z	1.2 Max.	0.048 Max.
Tape Width	T	6.0 +/- 0.4	0.236 +/- 0.016
Exposed Adhesive	E	0.8 Max.	0.032 Max.
Body Eccentricity	L1 – L2	1.0 Max.	0.040 Max.
Component Pitch A (2.0mm/10 pitch)	A	10.0	0.197
Component Pitch B (2.0mm/10 pitch)	B	52.4	1.023
Component Pitch A (2.0mm/20 pitch)	-	-	-
Component Pitch B (2.0mm/20 pitch)	-	-	-
Box Length	L	450.0 +/- 5.0	17.72 +/- 0.197
Box Width	W	215.0 +/- 5.0	8.46 +/- 0.197
Box Height	H	250.0 +/- 5.0	9.84 +/- 0.197

**GENERAL PURPOSE SILICON RECTIFIER R6 SERIES**

**AMMO PACK IN TAPE/BOX (Unit: mm)**

Case Code	Qty. Per Reel (pcs)	Component Space (mm)	Tape Space (mm)	Inner Box L*W*H (mm)	Carton size L*W*H (mm)	Qty. Per Carton (pcs)	G. W (kg)
R-6	500	10	52.4	198*86*21	450*215*250	5,000	7.45

**DISCLAIMER**

NextGen Component, Inc. reserves the right to make changes to the product(s) and or information contained herein without notice. No liability is assumed as a result of their use or application. No rights under any patent accompany the sale of any such product(s) or information