



SPECIFICATION SHEET

SPECIFICATION SHEET NO.	N0521-0805BBD8100S01
DATE	May 21, 2021
REVISION	A0
DESCRIPTION	<p>SMD LED 0805 series Dimensions: L2.0*W1.25*H0.8mm</p> <p>Color: Blue, White Diffused, 105 mcd Min.@20mA, 2.6V Min.</p> <p>Operating Temperature: -40 ~ 85°C</p> <p>Package: 3000pcs/Reel</p> <p>RoHS III and REACH Compliant</p>
CUSTOMER	
CUSTOMER PART NUMBER	
CROSS REF. PART NUMBER	
ORIGINAL PART NUMBER	BND-0805B-BD-810
PART CODE	0805BBD8100S01

VENDOR APPROVE			
Issued/Checked/Approved			
DATE: May 21, 2021			

CUSTOMER APPROVE	
DATE:	

MAIN FEATURE

- SMD LED 0805 series Dimensions: L2.0*W1.25*H0.8mm
- Wide Viewing Angle 120°
- Reflow Solderable
- High Luminous Intensity and Low Power Dissipation
- Cross main competitors parts
- RoHS/RoHS III compliant



APPLICATION

- Optical Indicator
- Indoor Display
- Backlighting in dashboard and switch

RFQ

[Request For Quotation](#)

PART CODE GUIDE

0805	BBD8100	S	01
1	2	3	4

- 1) 0805: Part family Code for SMD LED 0805 series Dimensions: L2.0*W1.25*H0.8mm
- 2) BBD8100: Type code for original part number BND-0805B-BD-810
- 3) S: Tape/Reel, Package: 3000pcs/reel
- 4) 01: Internal control code, 2 letter or digits

DIMENSION (Unit: mm, Tol: +/-0.2)

Image for reference

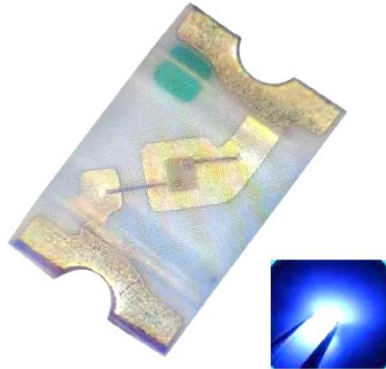

SMD 0805

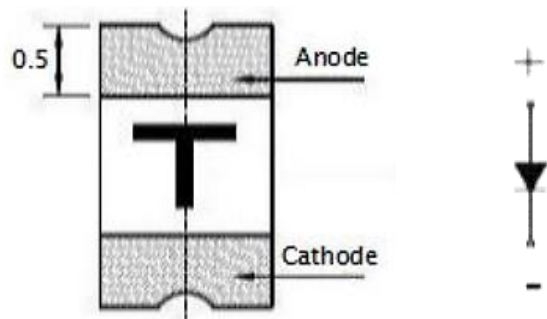
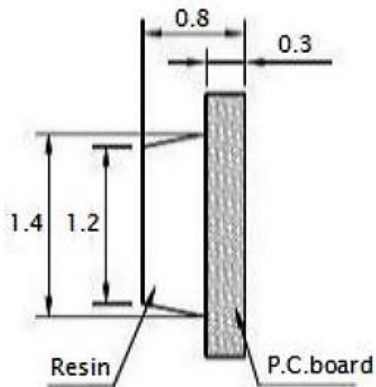
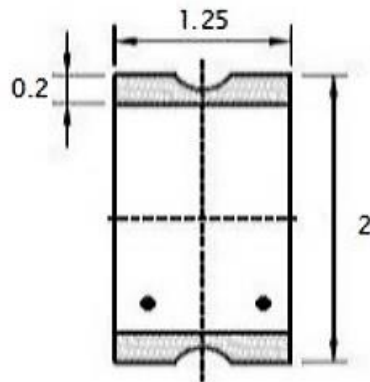

GENERAL PARAMETERS

Parameter	Part No. Symbol	Value
Original Manufacturer		Oriental Technology
Holder Type	0805	Dimensions L2.0*W1.25*H0.8mm
Dice	B	Blue (InGan)
Lens Type		White Diffused
Internal Code	BD	QC Dept. code
Sources Code	8100	For IC sources
Luminous Intensity (mcd) @20mA		105 ~ 140
Viewing Angle 2θ1/2		120
Package	S	Tape/Reel, Package: 3000pcs/reel
Internal Control Code	01	Code- 2 letter or digits
RoHS and REACH Status		RoHS III and REACH Compliant
Special code		The customer special requirement Blank: N/A

Reminds

1. 2θ1/2 is the angle from optical centerline where the luminous intensity is 2θ1/2 the optical centerline value
2. The above luminous intensity measurement allowance tolerance ±10%.

ELECTRONICAL/OPTICAL CHARACTERISTICS @ Ta = 25 °C

Parameter	Symbol	Unit	Value			Test Condition
			Min	Typ.	Max.	
Forward Voltage	V _F	V	2.6		3.0	I _F = 20mA
Reverse Current	I _R	μA			10	V _R = 5.0V
Dominate Wavelength	λ _d	nm	467		472	I _F = 20mA

ABSOLUTE MAXIMUM RATINGS @ Ta = 25 °C

Parameter	Symbol	Unit	Value		
			Min	Typ.	Max.
Power Dissipation	P _d	mW		90	
DC Forward Current	I _F	mA		20	
Peak Forward Current	I _{FP}	mA		30	
Reverse Voltage	V _R	V		5	
Electrostatic Discharge (HBM)	ESD	V		2000	
Operating Temperature Range	T _{opr}	°C	-40		+85
Storage Temperature Range	T _{stg}	°C	-40		+100

Reminds

- 1/10 Dut cycle 0.1ms pulse width
- The above forward voltage measurement allowance tolerance ±0.1V.
- The tolerance of Wave Length: ±0.1V.

TYPICAL OPTICAL CHARACTERISTICS CURVES

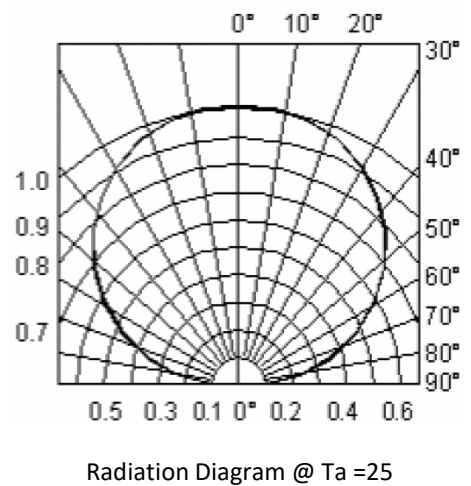
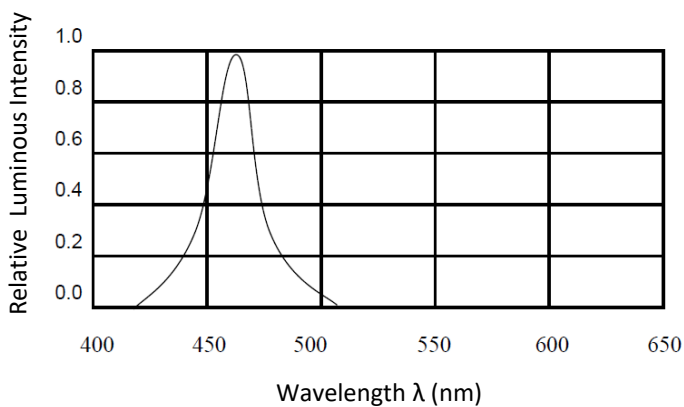
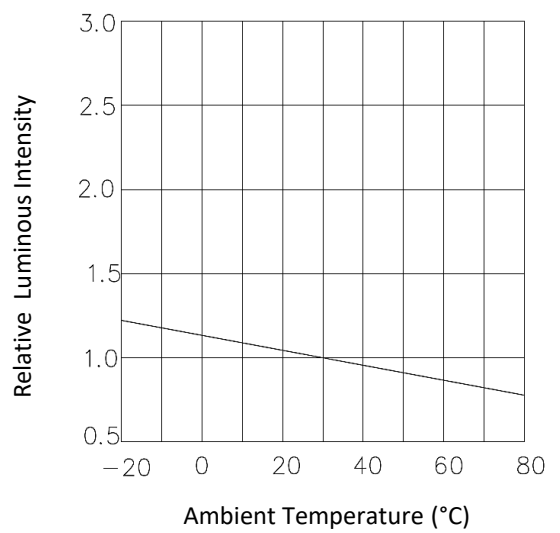
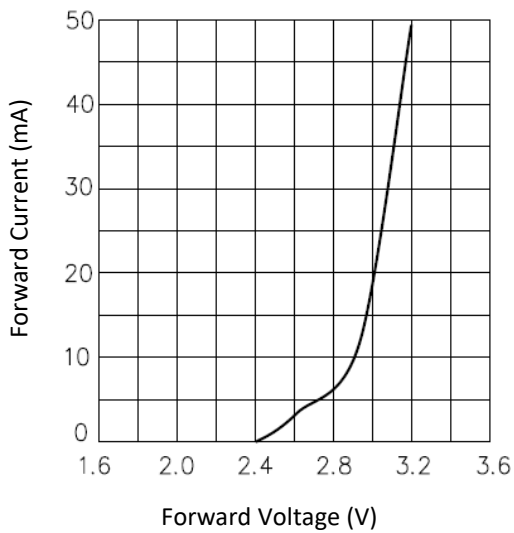
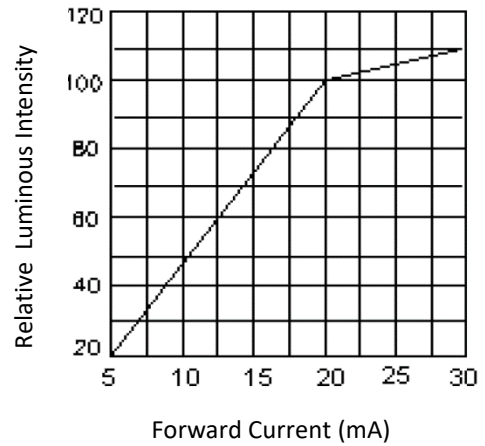
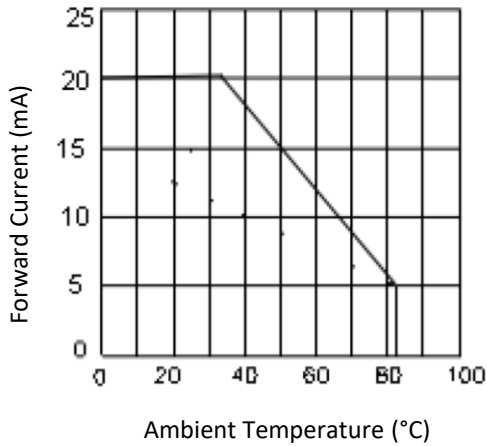



RELIABILITY TEST ITEMS AND CONDITION

Test Items	Test Conditions	Requirement
Solderability	Solder Temperature : 240 °C Solder Duration:3.5 +/-0.5 sec.	Solderable Area over 95%
Thermal Shock Followed by High Temperature & High Humidity Cyclic	-40° → 10min. 5 Cycles ↑ ↓ Shift (2~3) min 100 °C → 10min 25 °C ~55 °C (90%~ 95%) RH 2 Cycles for 48 hours. Recover for 2 hours.	C = 0 & I **
Resistance for Soldering Heat	Reflow Solder	
DC Operating Life	1000 hours Forward Current: 20 mA	
High Temperature Storage	100 °C → 1000 hrs.	
High Temperature & Humidity Cyclic	25 °C ~55 °C (90%~ 95%) RH 6 Cycles for 144 hours. Recover for 2 hours.	

Reminds

1. The reliability of products shall be satisfied with items listed above
2. Confidence level: 90%; LTPD:10%
3. The technical information shown in the data sheets are limited to the typical characteristics and related circuit samples.

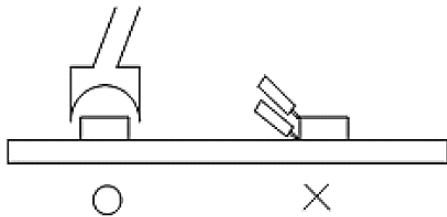
NOTICE CONDITION

Items	Test Conditions
<p>Soldering by Iron</p>	<ol style="list-style-type: none"> 1. The temperature of Iron must be lower than 300 °C, 3 second by hand soldering 2. The hand solder should be done only one times
<p>Repairing</p>	<p>Repair should not be done after the LEDs have been soldered. When repairing is unavoidable, a double-head soldering iron should be used (as below figure). It should be confirmed before if the characteristics of LEDS will or not be damaged by repair</p> 
<p>Storage</p>	<ol style="list-style-type: none"> 1. Package is sealed: Recommended storage condition @ 5°C ~30°C and Humidity 90% RH Max. for 24 months 2. Package is opened: Recommended storage condition @ 5°C ~30°C and Humidity 60% RH Max. for 1 months
<p>Caution</p>	<ol style="list-style-type: none"> 1. Don't stack together assembled PCBs containing LEDs. Impact may scratch the silicone lens or damage  2. Not available in the situation of Acidity for PH 

RECOMMENDED REFLOW SOLDERING

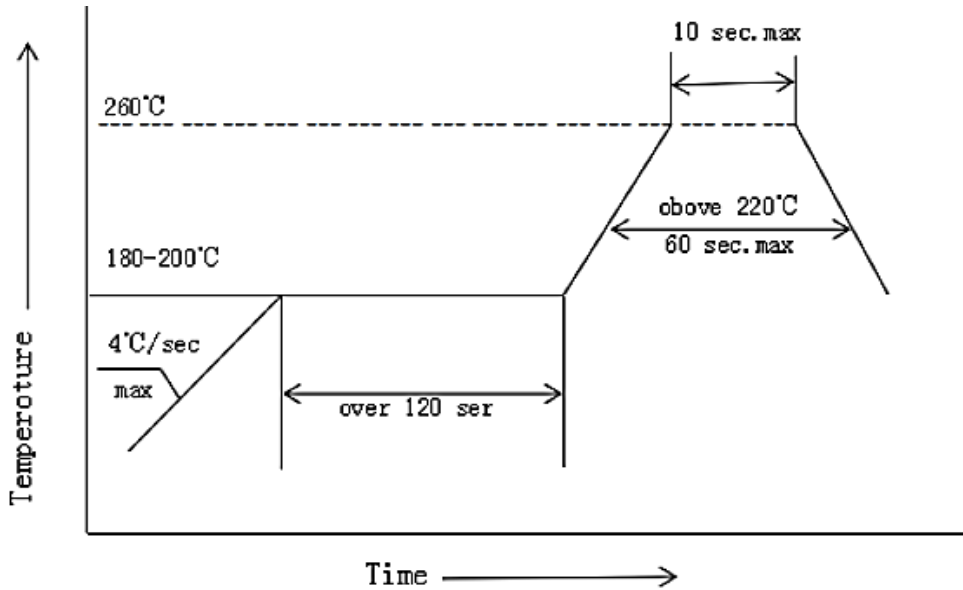

Reminds

1. The times of Reflow Soldering don't exceed 1 times.
2. Don't stress on the LEDs during heating

REEL 7"/180MM DIMENSION (Unit: mm, 3000pcs/Reel)

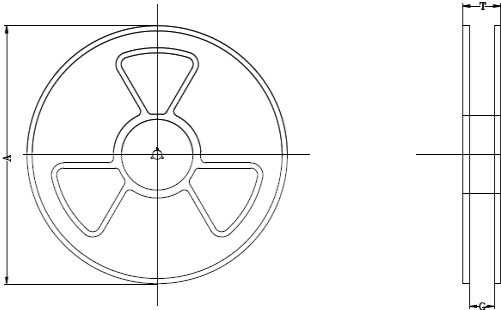

Code	Dimension
A	178.0+/-1.0
T	0.20+/-1.0

TAPE WIDE 8MM DIMENSION (Unit: mm)

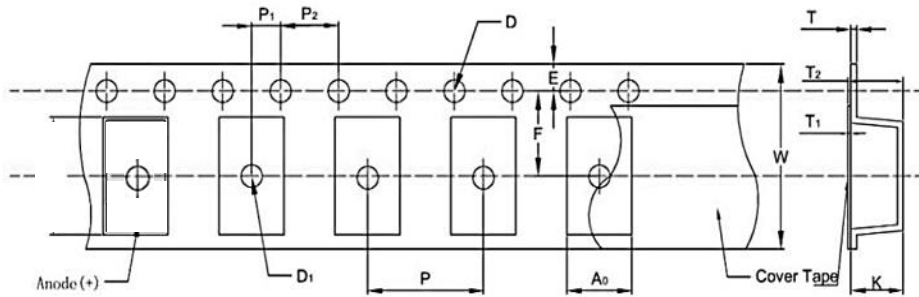

Code	Dimension
A 0	1.45+/-0.10
K	1.00+/-0.10
W	8.00+/-0.10
E	0.50+/-0.10
F	3.50+/-0.05
P	4.00+/-0.10
P 1	2.00+/-0.05
P2	4.00+/-0.10
D	1.50+/-0.20
D 1	1.10+/-0.10

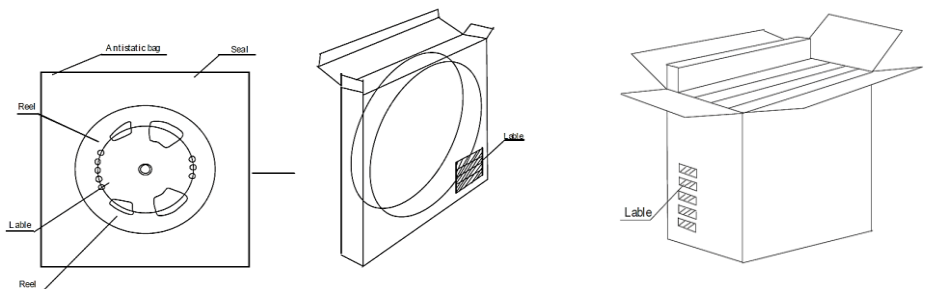
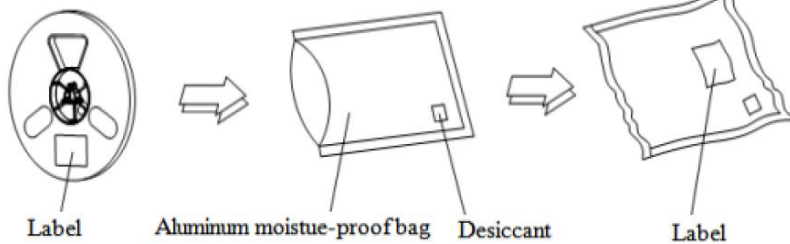

DISCLAIMER

NextGen Component, Inc. reserves the right to make changes to the product(s) and or information contained herein without notice. No liability is assumed as a result of their use or application. No rights under any patent accompany the sale of any such product(s) or information