



SPECIFICATION SHEET

SPECIFICATION SHEET NO.	R0126- BND0603JKRS001	
DATE	Jan. 26, 2024	
REVISION	A0	Updated With Most Recent Data - Official First Release
DESCRIPTION AND MAIN PARAMETRICS	<p>SMD LED 0603 Dimension L2.0*W1.25*H0.8mm, Color Red Clear</p> <p>Forward Voltage (VF) 1.8~2.4 V</p> <p>Dominant Wavelength Rank (WL) 620~630nm</p> <p>Luminous Intensity Rank (IV) 150~350mcd</p> <p>Operating Temp. Range -40°C ~+85°C</p> <p>Package in Tape/Reel,</p> <p>REACH/RoHS/RoHS III Compliant</p>	
CUSTOMER		
CUSTOMER PART NO.		
CROSS REF. PART NO.		
ORIGINAL MFG/PART NO.	Oriental Technology/BND-0603JKR	
PART CODE	BND0603JKRS001	

VENDOR APPROVE			
Issued/Checked/Approved			
DATE: Jan. 26, 2024			

CUSTOMER APPROVE	
DATE:	

SMD LED 0603 SERIES RED CLEAR COLOR

MAIN FEATURE

- Wide Viewing Angle 120 degree
- High Luminous Intensity and Low Power Dissipation
- Reflow Solderable
- Suitable for SMT process
- Cross Competitors Parts
- REACH/RoHS/RoHS III Complaint



APPLICATION

- Optical Indicator
- Indoor Display
- Backlighting In Dashboard And Switch
- Backlighting For LCD, Symbol And Display

RFQ
Request For Quotation

PART CODE GUIDE

BND0603	JK	R	S001	()
1	2	3	4	5

1. BND0603: Part family Code for SMD LED 0603 Series Red Clear Color Dimensions L2.0*W1.25*H0.8mm
2. JK: QC Code
3. R: Color code, R: Red Clear; B: Blue Clear; G: Pure Green; YG: Yellow Green Clear; W: White Clear; RGB: Red/Green/Blue Tri-color.
4. S001: Internal Control Code or special Parameters code letter A~Z or digits (1-9)
5. (): Custom Parameters code letter A~Z or digits (1-9); Blank: N/A

SMD LED 0603 SERIES RED CLEAR COLOR

DIMENSION – (Unit: mm, Tol.: +/-0.1mm)

Image For Reference

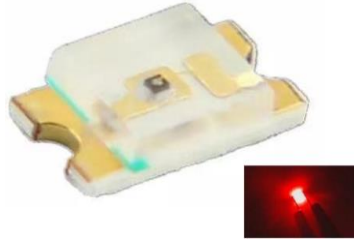

BND0603 Series

Size Code 0603

Dimension

L2.0*W1.25*H0.8mm

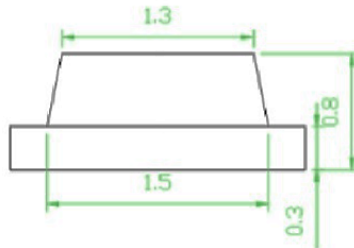
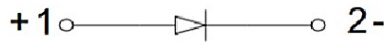
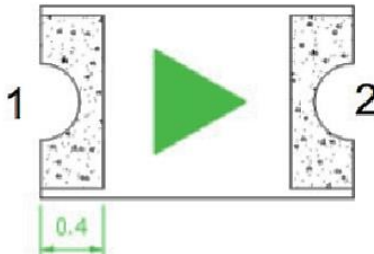
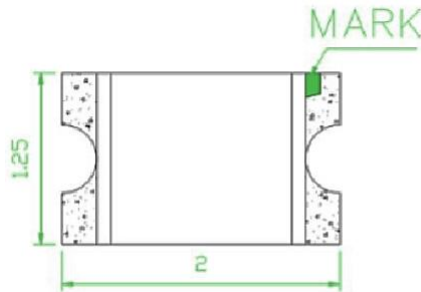

Recommend Pad Layout

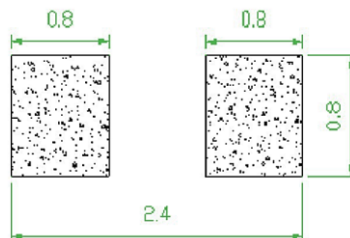

SMD LED 0603 SERIES RED CLEAR COLOR
MAXIMUM RATING $T_s=25^{\circ}\text{C}$, RH60%

PARAMETERS	SYMBOL	VALUES	UNIT
Operating Temperature	Top	-40~+85	°C
Storage Temperature	Tstg	-40~+85	°C
Junction Temperature	Tj	110	°C
Forward Current ($T_s=25^{\circ}\text{C}$)	IF	30	mA
Peak Forward Current Duty ratio=1/10, Pulse Width=0.1ms	IFs	100	mA
Reverse Voltage ($T_s=25^{\circ}\text{C}$)	VR	5.0	V
Electrostatic Discharge (acc.to ANSI/ESDA/JEDEC JS-001-2017)	VESD	≥2.0	kV

OPTICAL & ELECTRICAL CHARACTERISTICS $I_f=20\text{mA}$, $T_s=25^{\circ}\text{C}$, RH60%

Parameters	Symbol	Values			Unit
		Min.	Typ.	Max.	
Peak Wavelength	λ_{peak}	-	635	-	nm
Dominant wavelength	λ_{dom}	620	625	630	nm
Luminous Intensity Rank @20mA	Iv	150	-	350	mcd
Spectral bandwidth at 50% IV	$\Delta\lambda$	-	22	-	nm
Viewing Angle	$2\theta_{1/2}$	-	120	-	Deg
Forward Voltage	V _F	1.8	-	2.4	V
Reverse Current	I _R (V _R =5V)	-	-	10	μA
Power Dissipation	P _D	-	75	-	mW

SMD LED 0603 SERIES RED CLEAR COLOR

BIN CODE LIST

PARAMETERS	SYMBOL	VALUES	TOLERANCE	UNIT
Forward Voltage Rank (VF) @IF=20mA, Ts=25°C, RH60%	Vp	1.8~2.0	±0.05	V
	Vq	2.0~2.2		
	VL	2.2~2.4		
Dominant Wavelength Rank (WLD) @IF=20mA, Ts=25°C, RH60%	W5	620~625	±1.5	nm
	W6	625~630		
Luminous Intensity Rank (IV) @IF=20mA, Ts=25°C, RH60%	D14	150~200	±15%	mcd
	D15	200~250		
	D16	250~300		
	D17	300~350		

Note:

1. We support custom parameter on the basis of above mentioned Bin Code List if customer required.
2. Custom parameter code can be added as per Part Code Guide Page 2.

SMD LED 0603 SERIES RED CLEAR COLOR

REFLOW SOLDERING CHARACTERISTICS

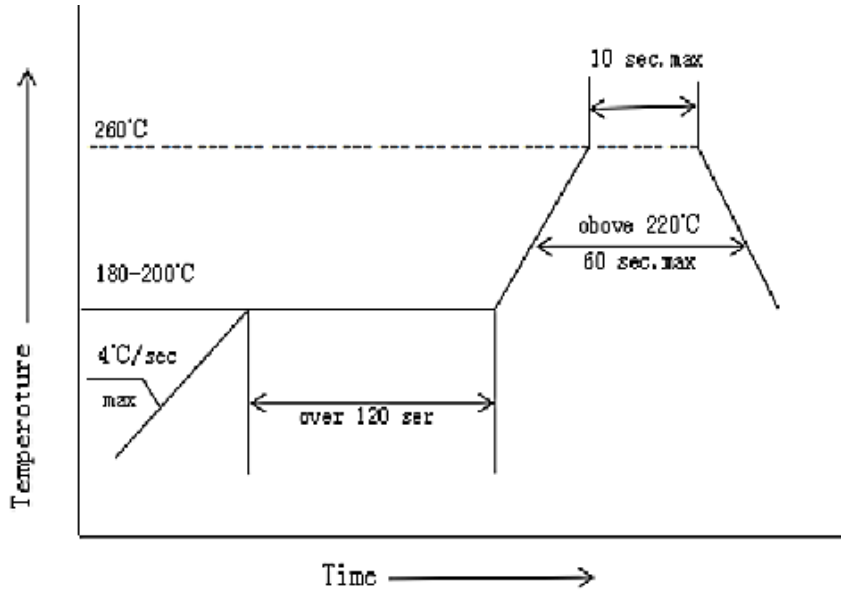

PROFILE FEATURE		PB-FREE ASSEMBLY
Average Ramp-up Rate (Ts Max to Tp)		4°C/second Max
Preheat	Temperature Min (Ts Min.)	180°C
	Temperature Max (Ts Max.)	200°C
	Time (ts Min. to ts Max.)	60~120 seconds Max.
Time maintained above	Temperature (Tl)	220°C
	Time(ts) maintained above TL	60 seconds Max.
Peak/Classification Temperature (Tp)		260 °C
Time within 5°C of actual Peak Temperature (tp)		10 seconds Max
Suggest reflow times		2 Times Max.

SMD LED 0603 SERIES RED CLEAR COLOR

OPTICAL & ELECTRICAL CHARACTERISTICS CURVES -IF=20mA, Ts=25°C, RH60%

Figure 1. Relative Intensity Vs Wavelength

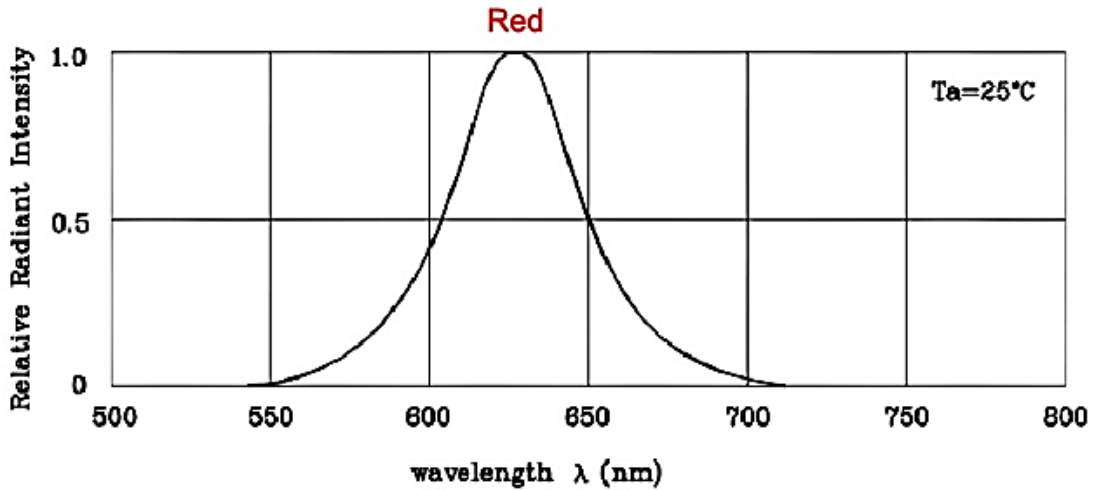
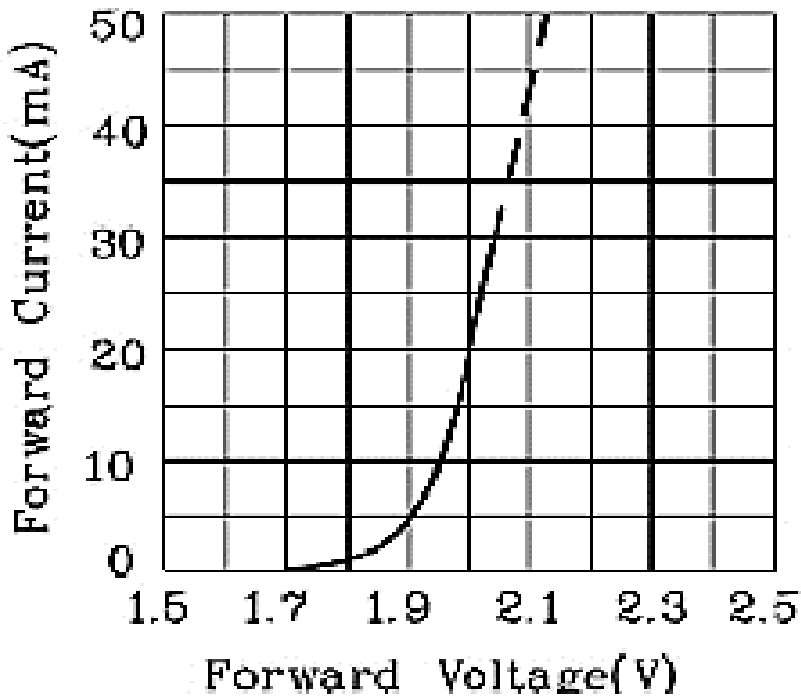

Figure 2. Forward Current Vs. Forward Voltage



SMD LED 0603 SERIES RED CLEAR COLOR

OPTICAL & ELECTRICAL CHARACTERISTICS CURVES - $I_F=20\text{mA}$, $T_s=25^\circ\text{C}$, RH60%

Figure 3. Luminous Intensity Vs. Forward Current

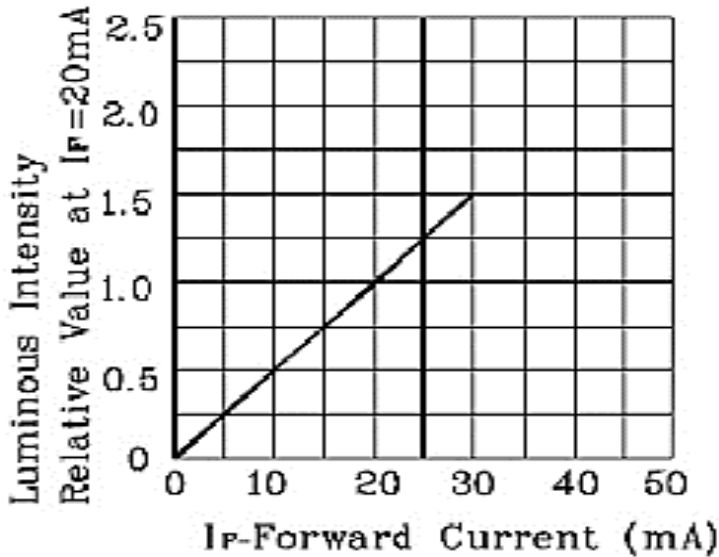
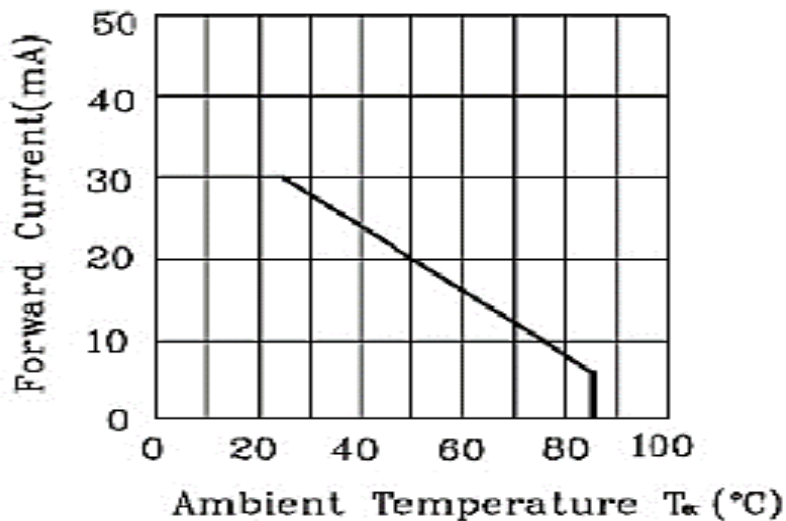

Figure 4. Forward Current Derating Curve



SMD LED 0603 SERIES RED CLEAR COLOR

OPTICAL & ELECTRICAL CHARACTERISTICS CURVES -IF=20mA, Ts=25°C, RH60%

Figure 5. Luminous Intensity Vs. Ambient Temperature

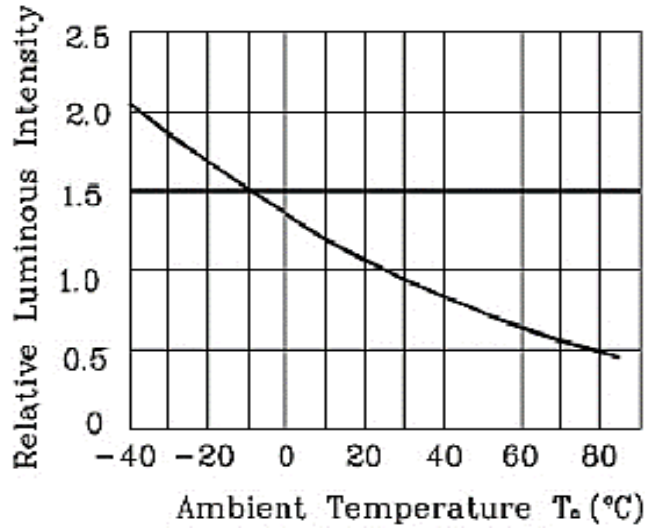
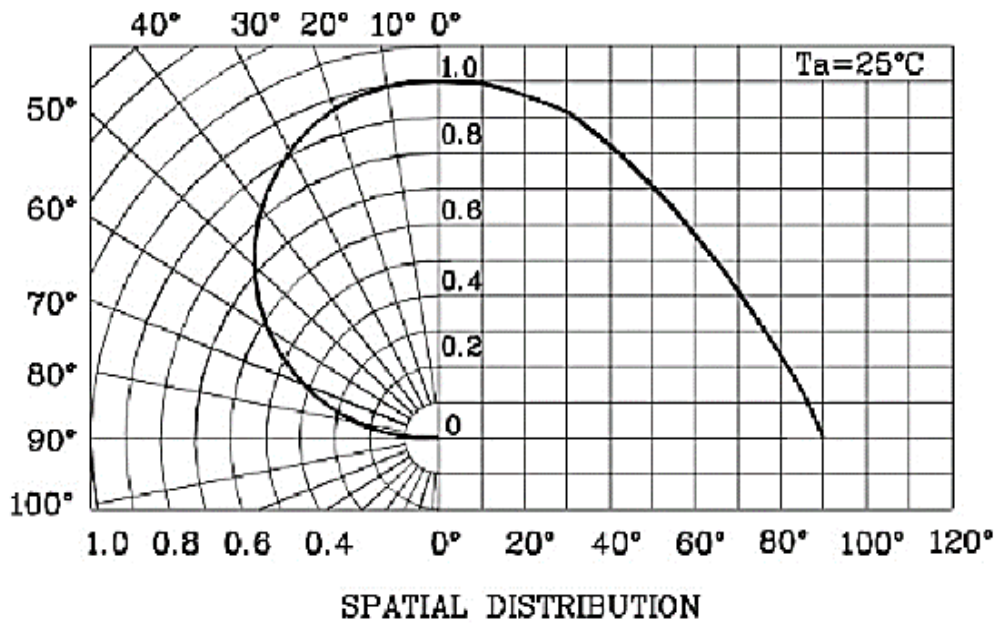

Figure 6. Radiation Diagram



SMD LED 0603 SERIES RED CLEAR COLOR

RELIABILITY TEST ITEMS AND CONDITION

TEST ITEMS	TEST CONDITIONS	REQUIREMENT
Solderability	Solder Temperature : 240 °C Solder Duration:3.5 +/-0.5 sec.	Solderable Area over 95%
Thermal Shock Followed by High Temperature & High Humidity Cyclic	-40° → 10min. 5 Cycles ↑ ↓ Shift (2~3) min 100 °C → 10min 25 °C ~55 °C (90%~ 95%) RH 2 Cycles for 48 hours. Recover for 2 hours.	C = 0 & I **
Resistance for Soldering Heat	Reflow Solder	
DC Operating Life	1000 hours Forward Current: 20 mA	
High Temperature Storage	100 °C → 1000 hrs.	
High Temperature & Humidity Cyclic	25 °C ~55 °C (90%~ 95%) RH 6 Cycles for 144 hours. Recover for 2 hours.	

Reminds

1. The reliability of products shall be satisfied with items listed above
2. Confidence level: 90%; LTPD:10%
3. The technical information shown in the data sheets are limited to the typical characteristics and related circuit samples.

SMD LED 0603 SERIES RED CLEAR COLOR

NOTICE CONDITION

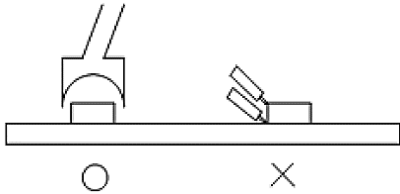
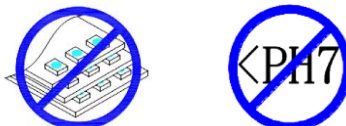
ITEMS	TEST CONDITIONS
Soldering by Iron	<ol style="list-style-type: none"> 1. The temperature of Iron must be lower than 300 °C, 3 second by hand soldering 2. The hand solder should be done only one times
Repairing	<p>Repair should not be done after the LEDs have been soldered. When repairing is unavoidable, a double-head soldering iron should be used (as below figure). It should be confirmed before if the characteristics of LEDS will or not be damaged by repair.</p> 
Storage	<ol style="list-style-type: none"> 1. Package is sealed: Recommended storage condition @ 5°C ~30°C and Humidity 90% RH Max. for 24 months 2. Package is opened: (1) After this bag is opened ,devices that will be applied to infrared to infrared reflow, vapor-phase reflow. A. Completed within 672 hour. B. Stored at 5°C~30°Cand 60% RH or less 3. If baking is required, devices must be baked under below conditions 24 hours at 60°C±3°C
Handling Precautions	<ol style="list-style-type: none"> 1. Don't stack together assembled PCBs containing LEDs. Impact may scratch the silicone lens or damage 2. Not available in the situation of Acidity for PH 

SMD LED 0603 SERIES RED CLEAR COLOR

REEL DIMENSION (Unit: mm 4000pcs/Reel)

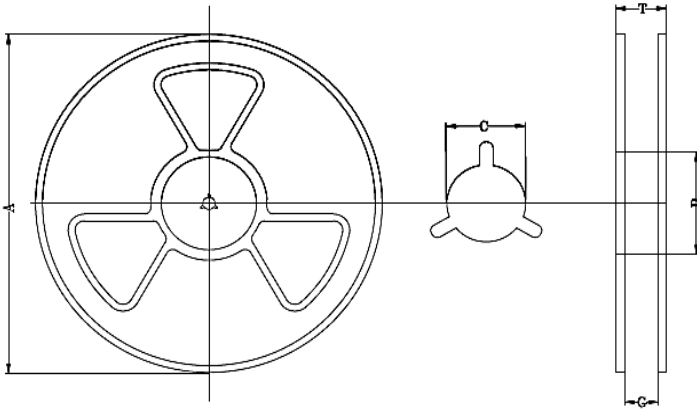

CODE	DIMENSION
A	178.0±2.0
B	Φ60±2.0
C	R6.5±0.5
G	9.0±1.0
T	12.0±1.0

TAPE DIMENSION (Unit mm)

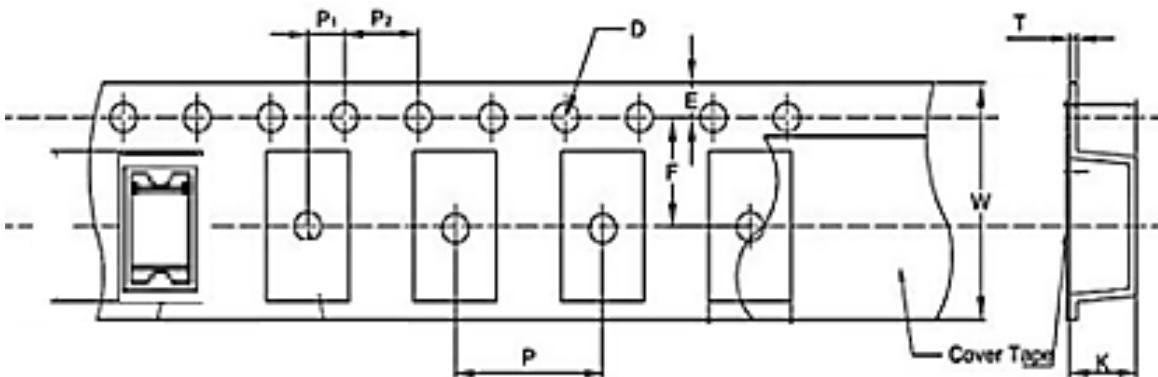

CODE	D	E	F	K	P	P1	P2	T	W
Dimension	1.50	1.75	3.50	0.70	4.00	2.00	4.00	0.235	8.00
	±0.20	±0.10	±0.05	±0.10	±0.10	±0.05	±0.10	±0.1	±0.30

SMD LED 0603 SERIES RED CLEAR COLOR

IMPORTANT NOTES AND DISCLAIMER

1. **ROHS COMPLIANCE:** The levels of RoHS restricted materials in this product are below the maximum concentration values (also referred to as the threshold limits) permitted for such substances, or are used in an exempted application, in accordance with EU RoHS Directive (EU) 2015/863 EC (RoHS3). RoHS Test Report for this product can be obtained at Download Center.
2. **REACH COMPLIANCE:** REACH substances of high concern (SVHCs) information is available for this product. Since the European Chemical Agency (ECHA) has published notice of their intent to frequently revise the SVHC listing for the foreseeable future, REACH Test Report for this product can be obtained at Download Center.
3. All Product parametric performance is indicated in the Electrical Characteristics for the listed herein test conditions, unless otherwise noted. Product performance may not be indicated by the Electrical Characteristics if operated under different conditions.
4. NextGen Component, Inc (*NextGen*) reserves the right to make changes to this document and its products and specifications at any time without notice. Customers should obtain and confirm the latest product information and specifications before final design, purchase or use.
5. *NextGen* makes no warranty, representation or guarantee regarding the suitability of its products for any particular purpose, not does *NextGen* assume any liability for application assistance or customer product design.
6. *NextGen* does not warrant or accept any liability with products which are purchased or used for any unintended or unauthorized application. No license is granted by implication or otherwise under any intellectual property rights of NextGen.
7. *NextGen* products are not authorized for use as critical components in life support devices or systems without express written approval by *NextGen*.
8. *NextGen* requires that customers first obtain an RMA (Returned Merchandise Authorization) number prior to returning any products. Returns must be made within 30 days of the date of invoice, be in the original packaging, unused and like-new condition. At the time of quoting or purchasing, a product may say that it is Non-Cancelable/ Non-Returnable (NCNR). These products are not returnable and not refundable.