



SPECIFICATION SHEET

SPECIFICATION SHEET NO.	R0313- RS2AWS000002F1	
DATE	March 13, 2024	
REVISION	A0	Updated With Most Recent Data - Official First Release
DESCRIPTION AND MAIN PARAMETRICS	<p>SMD Fast Recovery Rectifier, 2 Pads, Case SOD-123FL, RS Series, RS2AW Type, Reverse Voltage 50V Max. Forward Current 2.0A Max. Operating Temp. Range -55°C ~+150°C Package in Tape/Reel, 3000pcs/Reel RoHS III/REACH Compliant and Halogen Free (HF)</p>	
CUSTOMER		
CUSTOMER PART NO.		
CROSS REF. PART NO.		
ORIGINAL MFG/PART NO.	MDD/RS2AW	
PART CODE	RS2AWS000002F1	

VENDOR APPROVE			
Issued/Checked/Approved			
DATE: March 13, 2024			

CUSTOMER APPROVE	
DATE:	

SMD FAST RECOVERY RECTIFIER RS SERIES CASE SOD123FL

MAIN FEATURE

- Glass Passivated Device
- Low Reverse Leakage
- Metallurgically Bonded Construction
- High Temperature Soldering Guaranteed: 250°C/10 Seconds, 0.375”(9.5mm) Lead Length, 5 lbs. (2.3kg) Tension
- Surface Mount Package Ideally Suited for Automatic Insertion
- REACH/RoHS III Complaint and Halogen Free
- Cross Main Competitor Parts in Market



APPLICATION

- For SMD application

PART CODE GUIDE

RFQ
Request For Quotation

RS	2	A	WS00000	2F1
1	2	3	4	5

1. RS: Product Series Code, SMD Fast Recovery Rectifier, 2 Pads, Case SOD-123FL
2. 2: Forward Current Code, 2: 2.0A Max.
3. A: Reverse Voltage Code, A: 50V Max. ; B: 100V Max. ; D: 200V Max.; G: 400V Max.; J: 600V Max.; K: 800V Max.; M: 1000V Max.
4. WS00000: Internal Control Code, Custom letter A~Z, a-z or digits (0-9)
5. 2F1: Marking code for “2F1” on the case surface

SMD FAST RECOVERY RECTIFIER RS SERIES CASE SOD123FL

DIMENSION (Unit: Inch/mm)

Image for reference



Marking:

See Page 5- Marking List

For different Part code

SOD-123FL

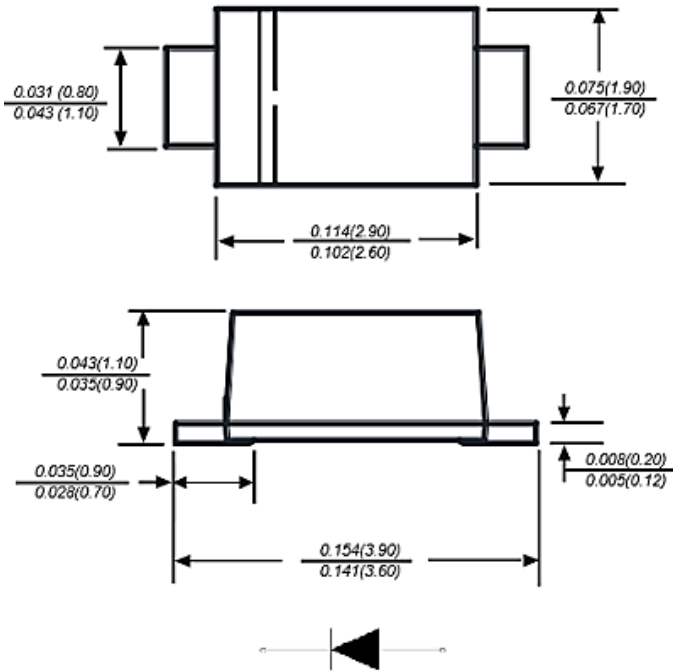

Recommend Pad Layout

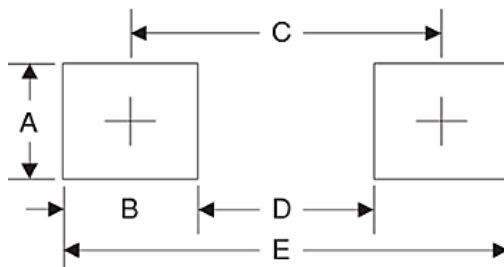

Symbol	Unit (mm)	Unit (Inch)
A	1.2	0.047
B	1.2	0.047
C	3.2	0.126
D	2.0	0.079
E	4.4	0.173

SMD FAST RECOVERY RECTIFIER RS SERIES CASE SOD123FL
MECHANICAL DATA

CASE	TERMINALS	POLARITY	MOUNTING POSITION	WEIGHT PER PIECE
JEDEC SOD-123FL molded plastic body	Solder plated, Solderable per MIL-STD-750, Method 2026	Polarity symbol marking on case	Any	0.00070 Ounce, 0.02000 grams

MAXIMUM RATINGS AND ELECTRICAL CHARACTERISTICS

Ratings at 25 °C ambient temperature unless otherwise specified. Single phase half-wave 60Hz, resistive or inductive load, for capacitive load current derate by 20%.

PARAMETER	SYMBOLS	VALUE	UNITS
		LIMIT	
Maximum Average Forward Rectified Current At TL (see fig.1)	I _{AV}	2.0	A
Peak Forward Surge Current 8.3ms Single Half Sine-wave Superimposed On Rated Load (JEDEC Method)	I _{FSM}	50	A
Maximum Instantaneous Forward Voltage At 1.0A	V _F	1.3	V
Maximum DC Reverse Current TA=25°C At Rated DC Blocking Voltage TA=125°C	I _R	5 100	mA
Typical Junction Capacitance (NOTE 1)	C _J	40	pF
Typical thermal resistance (NOTE 2)	R _{θJA}	75	°C/W
	R _{θJC}	22	°C/W
Operating Junction Temperature Range	T _J	-55 to +150	°C
Storage Temperature Range	T _{STG}	-55 to +150	°C

Note:

1. Measured at 1MHz and applied reverse voltage of 4.0V D.C.
2. Measured with I_F=0.3A, I_R=1A, I_{rr}=0.25A.
3. PCB mounted on 0.2*0.2" (5.0*5.0mm) copper pad area.

3/13/2024

4

SMD FAST RECOVERY RECTIFIER RS SERIES CASE SOD123FL

MAXIMUM RATINGS AND ELECTRICAL CHARACTERISTICS FOR DIFFERENT PART CODE

Ratings at 25 °C ambient temperature unless otherwise specified. Single phase half-wave 60Hz, resistive or inductive load, for capacitive load current derate by 20%.

PART CODE	Max. Repetitive Peak Reverse Voltage (V _{RRM})	Max. RMS Voltage (V _{RMS})	Max. DC Blocking Voltage (V _{DC})	Max. Reverse Recovery Time (t _{rr})	Marking List
	V	V	V	ns	
RS2AWS000002F1	50	35	50	150	2F1
RS2BWS000002F2	100	70	100	150	2F2
RS2DWS000002F3	200	140	200	150	2F3
RS2GWS000002F4	400	280	400	150	2F4
RS2JWS000002F5	600	420	600	250	2F5
RS2KWS000002F6	800	560	800	500	2F6
RS2MWS000002F7	1000	700	1000	500	2F7

SMD FAST RECOVERY RECTIFIER RS SERIES CASE SOD123FL

RATINGS AND CHARACTERISTIC CURVES (For Reference Only)

Fig.1 Forward Current Derating Curve

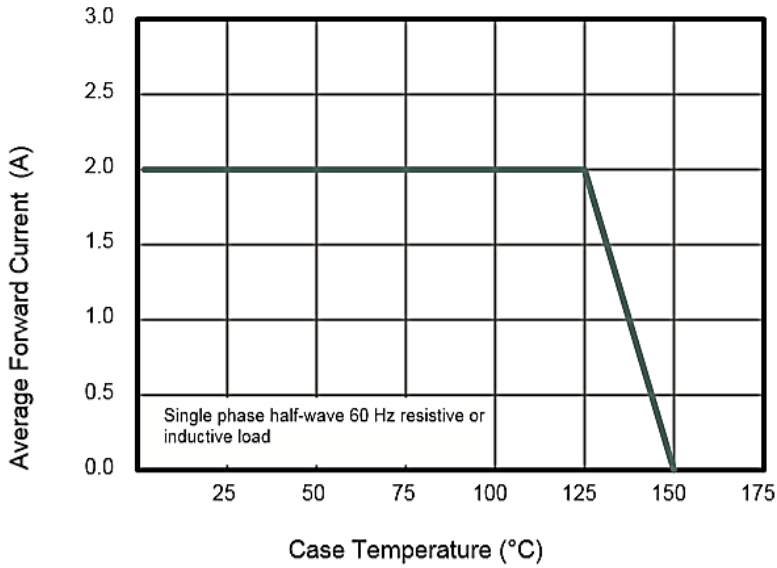
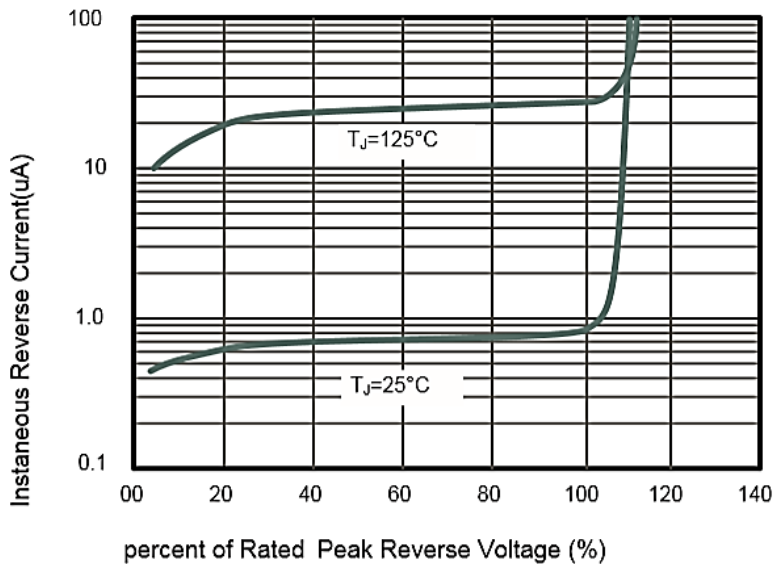

Fig.2 Typical Reverse Characteristics



SMD FAST RECOVERY RECTIFIER RS SERIES CASE SOD123FL

RATINGS AND CHARACTERISTIC CURVES (For Reference Only)

Fig.3 Typical Instaneous Forward Characteristics

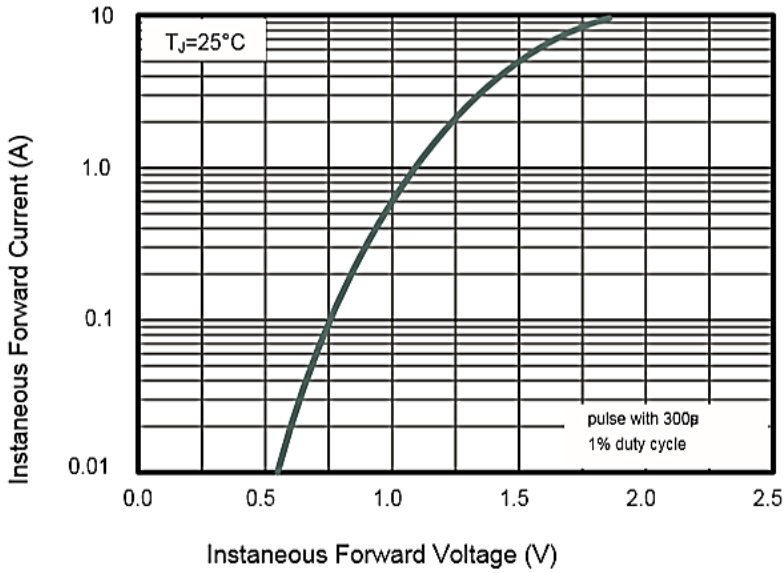
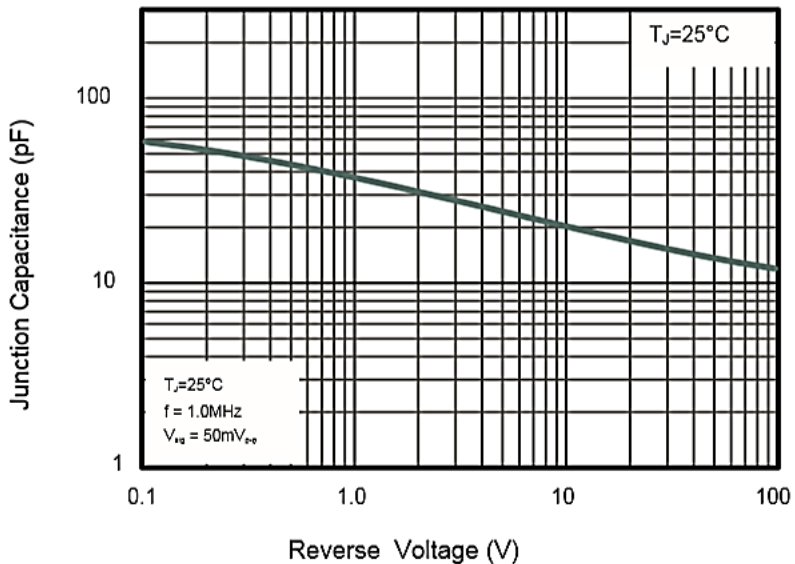

Fig.4 Typical Junction Capacitance



SMD FAST RECOVERY RECTIFIER RS SERIES CASE SOD123FL

RATINGS AND CHARACTERISTIC CURVES (For Reference Only)

Fig.5 Maximum Non-Repetitive Peak Forward Surge Current

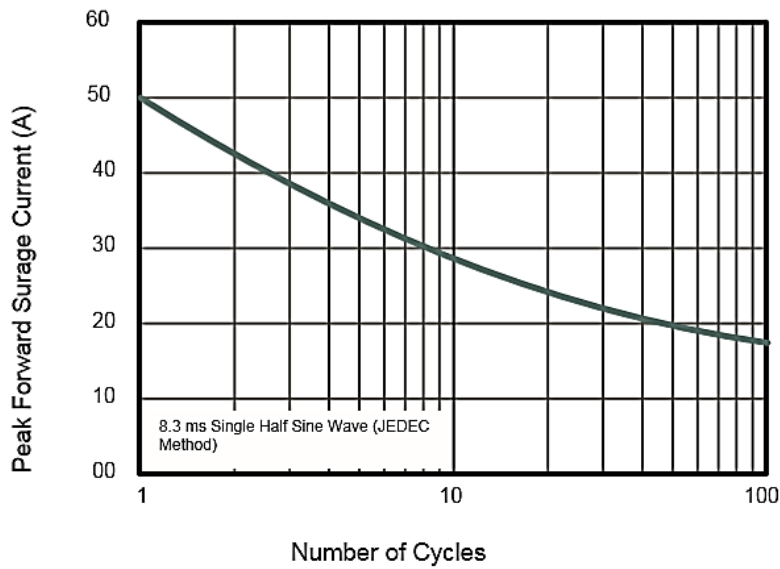

SMD FAST RECOVERY RECTIFIER RS SERIES CASE SOD123FL
RELIABILITY

NUMBER	EXPERIMENT ITEMS	EXPERIMENT METHOD AND CONDITIONS	REFERENCE DOCUMENTS
1	Solder Resistance Test	Test 260°C± 5°C for 10 ± 2 sec. Immerse body into solder 1/16" ± 1/32"	MIL-STD-750D METHOD-2031.2
2	Solderability Test	230°C ±5°C for 5 sec.	MIL-STD-750D METHOD-2026.1 0
3	Pull Test	1 kg in axial lead direction for 10 sec.	MIL-STD-750D METHOD-2036.4
4	Bend Test	0.5Kg Weight Applied To Each Lead, Bending Arcs 90 °C ± 5 °C For 3 Times	MIL-STD-750D METHOD-2036.4
5	High Temperature Reverse Bias Test	TA=100°C for 1000 Hours at VR=80% Rated VR	MIL-STD-750D METHOD-1038.4
6	Forward Operation Life Test	TA=25°C Rated Average Rectified Current	MIL-STD-750D METHOD-1027.3
7	Intermittent Operation Life Test	On state: 5 min with rated IRMS Power Off state: 5 min with Cool Forced Air. On and off for 1000 cycles.	MIL-STD-750D METHOD-1036.3
8	Pressure Cooker Test	15 PSIG, TA=121°C, 4 hours	MIL-S-19500 APPENOIXC
9	Temperature Cycling Test	-55°C~+125°C; 30 Minutes For Dwelled Time 5 minutes for transferred time. Total: 10 cycles.	MIL-STD-750D METHOD-1051.7
10	Thermal Shock Test	0°C for 5 minutes., 100°C for 5minutes, Total: 10 cycles	MIL-STD-750D METHOD-1056.7
11	Forward Surge Test	8.3ms Single Sale Sine-wave One Surge.	MIL-STD-750D METHOD-4066.4
12	Humidity Test	TA=65°C, RH=98% for 1000 hours.	MIL-STD-750D METHOD-1021.3
13	High Temperature Storage life Test	150°C for 1000 Hours	MIL-STD-750D METHOD-1031.5

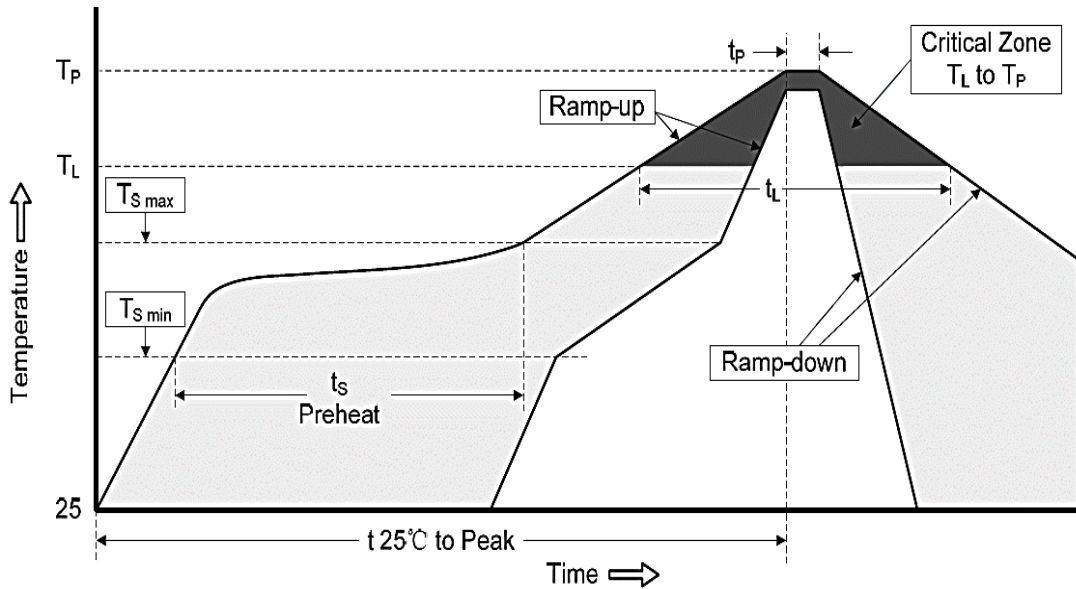
SMD FAST RECOVERY RECTIFIER RS SERIES CASE SOD123FL
SUGGESTED REFLOW PROFILE - For Reference Only

PROFILE FEATURE		PB-FREE ASSEMBLY
Average Ramp-up Rate (Ts Max to Tp)		3°C/second Max
Preheat	Temperature Min (Ts Min.)	150°C
	Temperature Max (Ts Max.)	200°C
	Time (ts Min. to ts Max.)	60 ~ 180 seconds
Time maintained above	Temperature (Tl)	217°C
	Time (tl)	60 ~ 150 seconds
Peak/Classification Temperature (Tp)		260 °C
Time within 5°C of actual Peak Temperature (tp)		20 ~ 40 seconds
Ramp-down rate		6 °C /Second Max.
Time 25 °C to Peak Temperature		8 minutes Max.
Suggest reflow times		3 Times Max.

SMD FAST RECOVERY RECTIFIER RS SERIES CASE SOD123FL
TAPE/REEL (Unit: mm)

All Devices are packed in accordance with EIA standard RS-481-A and specifications.

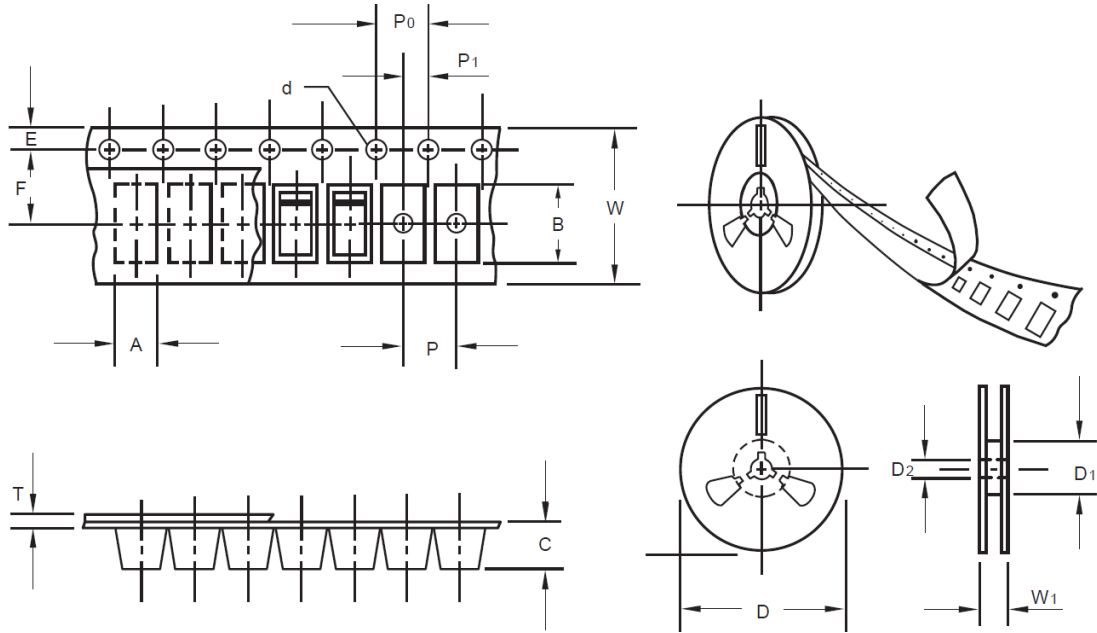

ITEM	SYMBOL	TOLERANCE	SOD-123FL
Carrier width	A	0.1	2.10
Carrier Length	B	0.1	4.00
Carrier Depth	C	0.1	1.60
Sprocket hole	d	0.05	1.55
7"Reel outside diameter	D	2.0	178.00
7"Reel inner diameter	D1	Min.	50.00
Feed hole diameter	D2	0.5	13.00
Sprocket hole position	E	0.1	1.75
Punch hole position	F	0.1	3.50
Punch hole pitch	P	0.1	4.00
Sprocket hole pitch	P0	0.1	4.00
Embossment center	P1	0.1	2.00
Overall tape thickness	T	0.1	0.25
Tape width	W	0.3	8.15
Reel width	W1	1.0	10.50
MPQ/Reel	3000pcs/Reel		

SMD FAST RECOVERY RECTIFIER RS SERIES CASE SOD123FL

ROHS COMPLIANCE

- The levels of RoHS restricted materials in this product are below the maximum concentration values (also referred to as the threshold limits) permitted for such substances, or are used in an exempted application, in accordance with EU RoHS Directive (EU) 2015/863 EC (RoHS3). RoHS Test Report for this product can be obtained can be obtained at Download Center.

REACH COMPLIANCE

- REACH substances of high concern (SVHCs) information is available for this product. Since the European Chemical Agency (ECHA) has published notice of their intent to frequently revise the SVHC listing for the foreseeable future, REACH Test Report for this product can be obtained can be obtained at Download Center.

IMPORTANT NOTES AND DISCLAIMER

1. All Product parametric performance is indicated in the Electrical Characteristics for the listed herein test conditions, unless otherwise noted. Product performance may not be indicated by the Electrical Characteristics if operated under different conditions.
2. NextGen Component, Inc (*NextGen*) reserves the right to make changes to this document and its products and specifications at any time without notice. Customers should obtain and confirm the latest product information and specifications before final design, purchase or use.
3. *NextGen* makes no warranty, representation or guarantee regarding the suitability of its products for any particular purpose, not does NextGen assume any liability for application assistance or customer product design.
4. *NextGen* does not warrant or accept any liability with products which are purchased or used for any unintended or unauthorized application. No license is granted by implication or otherwise under any intellectual property rights of NextGen.
5. *NextGen* products are not authorized for use as critical components in life support devices or systems without express written approval by *NextGen*.
6. *NextGen* requires that customers first obtain an RMA (Returned Merchandise Authorization) number prior to returning any products. Returns must be made within 30 days of the date of invoice, be in the original packaging, unused and like-new condition. At the time of quoting or purchasing, a product may say that it is Non-Cancelable/ Non-Returnable (NCNR). These products are not returnable and not refundable.