



DATA SHEET NO.	R0426 - SMCJ85A000SGGV	
DATE	Apr.26, 2024	
REVISION	A1	Updated With Most Recent Data
DESCRIPTION AND MAIN PARAMETRICS	<p>SMD Transient Voltage Suppressor (TVs) Diodes, SMC/DO-214AB series, 2 Pads, Unidirectional Type, Stand-off Voltage 85V, Peak Pulse Power: 1500W Min. , Peak Pulse Current: 11.1A Operating Temp. Range -65°C ~+150°C Package in Tape/Reel, 3000pcs/Reel REACH/RoHS/RoHS III Compliant</p>	
CUSTOMER		
CUSTOMER PART NO.		
CROSS REF. PART NO.		
ORIGINAL MFG/PART NO	MDD SMCJ85A	
PART CODE	SMCJ85A000SGGV	

VENDOR APPROVE		
Issued/Checked/Approved		
		
DATE: Apr. 26, 2024		

CUSTOMER APPROVE	
DATE:	

SMD TRANSIENT VOLTAGE SUPPRESSORS DIODES SMCJ SERIES

MAIN FEATURE

- The Plastic Package Carries Underwriters Laboratory Flammability Classification 94V-0
- Space Low Profile Package
- Built-in Strain Relief
- High Temperature Soldering Guaranteed: 260°C/ 10 Seconds At Terminals
- Glass Passivated Chip Junction
- Low Inductance
- Excellent Clamping Capability
- 1500W Peak Pulse Power Capability At 10/1000µs Waveform
- Repetition Rate (Duty Cycle): 0.01%
- Fast Response Time
- Repetition Rate (Duty Cycle): 0.01%
- Typical IR Less Than 1µa Above 10V



APPLICATION

- For SMD application
- I/O interface
- AC/DC power supply
- Low frequency signal transmission line (RS232, RS485, etc.)

ELECTRICAL CHARACTERISTICS

- See Page 5~ Page 11

SMD TRANSIENT VOLTAGE SUPPRESSORS DIODES SMCJ SERIES

HOW TO ORDER

- Please Follow Up Part Code Guide And Indicate Pat Code When You Order or RFQ

PART CODE GUIDE

[RFQ](#)
[Request For Quotation](#)

SMCJ	85A	000S	GGV
1	2	3	4

1. SMCJ: SMD Transient Voltage Suppressor (TVs) Diodes, SMC/DO-214AB series
2. 85A: Unidirectional Type, Stand-off Voltage: 85V
3. 000S: Internal Control Code or Special Parameters Code, Letter A~Z, a~z or digits 0~9
4. GGV: Marking code “GGV” on the case surface.

SMD TRANSIENT VOLTAGE SUPPRESSORS DIODES SMCJ SERIES

DIMENSION (Unit: Inch/mm)

Image for reference



Marking:

See Page 6~ Page 11

Marking Code List

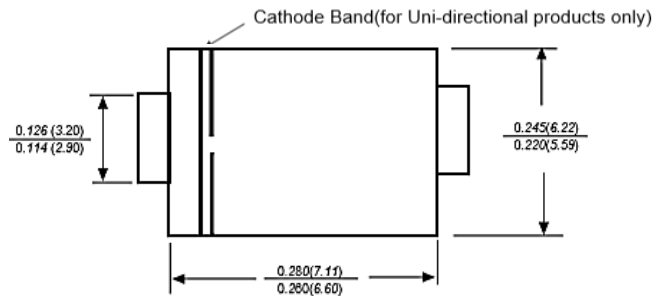

Case Code:

SMC/DO-214AB

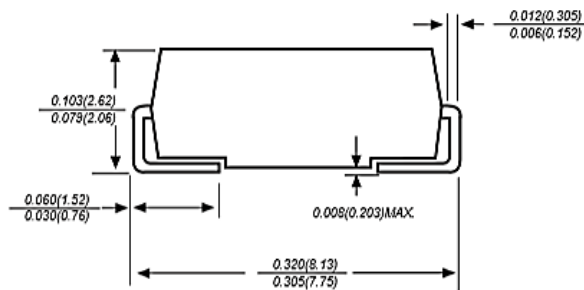

Recommend Pad Layout

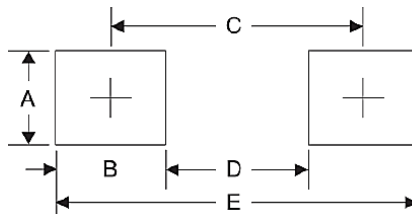

Symbol	Unit (inch)	Unit (mm)
A	0.170	4.30
B	0.160	4.10
C	0.311	7.90
D	0.150	3.80
E	0.472	12.0

SMD TRANSIENT VOLTAGE SUPPRESSORS DIODES SMCJ SERIES

MECHANICAL DATA

CASE	TERMINALS	POLARITY	MOUNTING POSITION	MARKING	WEIGHT PER PIECE
JEDEC SMC/DO-214AB molded plastic body	Solderable per MIL-STD- 750, Method 2026	Polarity symbol marking on body	Any	See Marking Code List	0.0030 Ounce, 0.095 Grams

MAX. RATING & CHARACTERISTICS - Ratings at 25°C Ambient Temperature Unless Otherwise Specified.

PARAMETER	SYMBOLS	VALUE	UNITS
Peak Pulse Power Dissipation At 10/1000µs Waveform (Note1, Note2, Fig.1)	P ppm	1500 Min.	W
Peak Pulse Current On 10/1000 Us Waveform (Note 1) Fig 3	I PPM	See Table 1~Table 6	A
Steady State Power Dissipation At TA=50°C (Fig.5)	P M(AV)	6.5	W
Peak Forward Surge Current, 8.3ms Single Half Sine-wave Superimposed On Rated Load, (JEDEC Method) (Note3, Fig.6)	I FSM	200	A
Operating Junction And Storage Temperature Range	T J, T stg	-65 ~ +150	°C
Typical Thermal Resistance Junction To Lead	R θJL	15	°C/W
Typical Thermal Resistance Junction To Ambient	R θJA	75	°C/W

Note

1. Non-repetitive current pulse, per Fig 3 and derated above TA=25 °C per Fig 2
2. Mounted on 5.0*5.0mm (0.03mm thickness) copper pads to each terminal
3. 8.3ms single half sinewave or equivalent square wave, duty cycle=4 pulsed per minute Max.

SMD TRANSIENT VOLTAGE SUPPRESSORS DIODES SMCJ SERIES

UNIDIRECTIONAL TYPE- ELECTRICAL CHARACTERISTICS - Ta = 25°C

Table 1

Part Code	Reverse Stand-off Voltage	Breakdown Voltage		Test Current	Reverse Leakage Max.	Max. Clamp Voltage	Peak Pulse Current	Marking Code
		V BR @ I T						
	V RMV	Min	Max	I T	I R @ V RWM	V C @ I PPM	I PPM	
	V	V	V	mA	µA	V	A	
SMCJ050A00SGDE	5	6.4	7	10	800	9.2	163.0	GDE
SMCJ060A00SGDG	6	6.67	7.37	10	800	10.3	145.7	GDG
SMCJ065A00SGDK	6.5	7.22	7.98	10	500	11.2	134.0	GDK
SMCJ070A00SGDM	7	7.78	8.6	10	100	12	125.0	GDM
SMCJ075A00SGDP	7.5	8.33	9.21	1	50	12.9	116.3	GDP
SMCJ080A00SGDR	8	8.89	9.83	1	20	13.6	110.3	GDR
SMCJ085A00SGDT	8.5	9.44	10.4	1	10	14.4	104.2	GDT
SMCJ090A00SGDV	9	10	11.1	1	5	15.4	97.4	GDV
SMCJ10A000SGDX	10	11.1	12.3	1	1	17	88.3	GDX
SMCJ11A000SGDZ	11	12.2	13.5	1	1	18.2	82.6	GDZ
SMCJ12A000SGEE	12	13.3	14.7	1	1	19.9	75.4	GEE
SMCJ13A000SGEG	13	14.4	15.9	1	1	21.5	69.8	GEG
SMCJ14A000SGEK	14	15.6	17.2	1	1	23.2	64.7	GEK
SMCJ15A000SGEM	15	16.7	18.5	1	1	24.4	61.5	GEM
SMCJ16A000SGEP	16	17.8	19.7	1	1	26	57.7	GEP
SMCJ17A000SGER	17	18.9	20.9	1	1	27.6	54.4	GER
SMCJ18A000SGET	18	20	22.1	1	1	29.2	51.4	GET
SMCJ20A000SGEV	20	22.2	24.5	1	1	32.4	46.3	GEV
SMCJ22A000SGEX	22	24.4	26.9	1	1	35.5	42.3	GEX
SMCJ24A000SGEZ	24	26.7	29.5	1	1	38.9	38.6	GEZ

SMD TRANSIENT VOLTAGE SUPPRESSORS DIODES SMCJ SERIES

UNIDIRECTIONAL TYPE- ELECTRICAL CHARACTERISTICS - Ta = 25°C

Table 2

Part Code	Reverse Stand-off Voltage	Breakdown Voltage		Test Current	Reverse Leakage Max.	Max. Clamp Voltage	Peak Pulse Current	Marking Code
		V BR @ I T						
	V RMV	Min	Max	I T	I R @ V RWM	V C @ I PPM	I PPM	
	V	V	V	mA	µA	V	A	
SMCJ26A000SGFE	26	28.9	31.9	1	1	42.1	35.7	GFE
SMCJ28A000SGFG	28	31.1	34.4	1	1	45.4	33.1	GFG
SMCJ30A000SGFK	30	33.3	36.8	1	1	48.4	31.0	GFK
SMCJ33A000SGFM	33	36.7	40.6	1	1	53.3	28.2	GFM
SMCJ36A000SGFP	36	40	44.2	1	1	58.1	25.9	GFP
SMCJ40A000SGFR	40	44.4	49.1	1	1	64.5	23.3	GFR
SMCJ43A000SGFt	43	47.8	52.8	1	1	69.4	21.7	GFT
SMCJ45A000SGFV	45	50	55.3	1	1	72.7	20.6	GFV
SMCJ48A000SGFX	48	53.3	58.9	1	1	77.4	19.4	GFX
SMCJ51A000SGFZ	51	56.7	62.7	1	1	82.4	18.2	GFZ
SMCJ54A000SGGE	54	60	66.3	1	1	87.1	17.3	GGE
SMCJ58A000SGGG	58	64.4	71.2	1	1	93.6	16.1	GGG
SMCJ60A000SGGK	60	66.7	73.7	1	1	96.8	15.5	GGK
SMCJ64A000SGGM	64	71.1	78.6	1	1	103	14.6	GGM
SMCJ70A000SGGP	70	77.8	86	1	1	113	13.3	GGP
SMCJ75A000SGGR	75	83.3	92.1	1	1	121	12.4	GGR
SMCJ78A000SGGT	78	86.7	95.8	1	1	126	11.9	GGT
SMCJ85A000SGGV	85	94.4	104	1	1	137	11.0	GGV
SMCJ90A000SGGX	90	100	111	1	1	146	10.3	GGX
SMCJ100A00SGGZ	100	111	123	1	1	162	9.3	GGZ

SMD TRANSIENT VOLTAGE SUPPRESSORS DIODES SMCJ SERIES

UNIDIRECTIONAL TYPE- ELECTRICAL CHARACTERISTICS - Ta = 25°C

Table 3

Part Code	Reverse Stand-off Voltage	Breakdown Voltage		Test Current	Reverse Leakage Max.	Max. Clamp Voltage	Peak Pulse Current	Marking Code
		V BR @ I T						
	V RMV	Min	Max	I T	I R @ V RWM	V C @ I PPM	I PPM	
	V	V	V	mA	µA	V	A	
SMCJ110A00SGHE	110	122	135	1	1	177	8.5	GHE
SMCJ120A00SGHG	120	133	147	1	1	193	7.8	GHG
SMCJ130A00SGHK	130	144	159	1	1	209	7.2	GHK
SMCJ150A00SGHM	150	167	185	1	1	243	6.2	GHM
SMCJ160A00SGHP	160	178	197	1	1	259	5.8	GHP
SMCJ170A00SGHR	170	189	209	1	1	275	5.5	GHR
SMCJ180A00SGHT	180	201	222	1	1	292	5.1	GHT
SMCJ190A00SGHU	190	211	232	1	1	308	4.8	GHU
SMCJ200A00SGHV	200	224	247	1	1	324	4.6	GHV
SMCJ210A00SGHW	210	237	263	1	1	340	4.4	GHW
SMCJ220A00SGHX	220	246	272	1	1	356	4.2	GHX
SMCJ250A00SGHZ	250	279	309	1	1	405	3.7	GHZ
SMCJ300A00SGJE	300	335	371	1	1	486	3.1	GJE
SMCJ350A00SGJG	350	391	432	1	1	567	2.6	GJG
SMCJ400A00SGJK	400	447	494	1	1	648	2.3	GJK
SMCJ440A00SGJM	440	492	543	1	1	713	2.1	GJM

SMD TRANSIENT VOLTAGE SUPPRESSORS DIODES SMCJ SERIES

BIDIRECTIONAL TYPE- ELECTRICAL CHARACTERISTICS - Ta = 25°C

Table 4

Part Code	Reverse Stand-off Voltage	Breakdown Voltage		Test Current	Reverse Leakage Max.	Max. Clamp Voltage	Peak Pulse Current	Marking Code
		V BR @ I T						
	V RMV	Min	Max	I T	I R @ V RWM	V C @ I PPM	I PPM	
	V	V	V	mA	µA	V	A	
SMCJ050CA0SBDE	5	6.4	7	10	800	9.2	163.0	BDE
SMCJ060CA0SBDG	6	6.67	7.37	10	800	10.3	145.7	BDG
SMCJ065CA0SBDK	6.5	7.22	7.98	10	500	11.2	134.0	BDK
SMCJ070CA0SBDM	7	7.78	8.6	10	100	12	125.0	BDM
SMCJ075CA0SBDP	7.5	8.33	9.21	1	50	12.9	116.3	BDP
SMCJ080CA0SBDR	8	8.89	9.83	1	20	13.6	110.3	BDR
SMCJ085CA0SBDT	8.5	9.44	10.4	1	10	14.4	104.2	BDT
SMCJ090CA0SBDV	9	10	11.1	1	5	15.4	97.4	BDV
SMCJ10CA00SBDX	10	11.1	12.3	1	1	17	88.3	BDX
SMCJ11CA00SBDZ	11	12.2	13.5	1	1	18.2	82.6	BDZ
SMCJ12CA00SBEE	12	13.3	14.7	1	1	19.9	75.4	BEE
SMCJ13CA00SBEG	13	14.4	15.9	1	1	21.5	69.8	BEG
SMCJ14CA00SBEK	14	15.6	17.2	1	1	23.2	64.7	BEK
SMCJ15CA00SBEM	15	16.7	18.5	1	1	24.4	61.5	BEM
SMCJ16CA00SBEP	16	17.8	19.7	1	1	26	57.7	BEP
SMCJ17CA00SBER	17	18.9	20.9	1	1	27.6	54.4	BER
SMCJ18CA00SBET	18	20	22.1	1	1	29.2	51.4	BET
SMCJ20CA00SBEV	20	22.2	24.5	1	1	32.4	46.3	BEV
SMCJ22CA00SBEX	22	24.4	26.9	1	1	35.5	42.3	BEX
SMCJ24CA00SBEZ	24	26.7	29.5	1	1	38.9	38.6	BEZ

SMD TRANSIENT VOLTAGE SUPPRESSORS DIODES SMCJ SERIES

BIDIRECTIONAL TYPE- ELECTRICAL CHARACTERISTICS - Ta = 25°C

Table 5

Part Code	Reverse Stand-off Voltage	Breakdown Voltage		Test Current	Reverse Leakage Max.	Max. Clamp Voltage	Peak Pulse Current	Marking Code
		V BR @ I T						
	V RMV	Min	Max	I T	I R @ V RWM	V C @ I PPM	I PPM	
	V	V	V	mA	µA	V	A	
SMCJ26CA00SBFE	26	28.9	31.9	1	1	42.1	35.7	BFE
SMCJ28CA00SBFG	28	31.1	34.4	1	1	45.4	33.1	BFG
SMCJ30CA00SBFK	30	33.3	36.8	1	1	48.4	31.0	BFK
SMCJ33CA00SBFM	33	36.7	40.6	1	1	53.3	28.2	BFM
SMCJ36CA00SBFP	36	40	44.2	1	1	58.1	25.9	BFP
SMCJ40CA00SBFR	40	44.4	49.1	1	1	64.5	23.3	BFR
SMCJ43CA00SBFT	43	47.8	52.8	1	1	69.4	21.7	BFT
SMCJ45CA00SBFV	45	50	55.3	1	1	72.7	20.6	BFV
SMCJ48CA00SBFX	48	53.3	58.9	1	1	77.4	19.4	BFX
SMCJ51CA00SBFZ	51	56.7	62.7	1	1	82.4	18.2	BFZ
SMCJ54CA00SBGE	54	60	66.3	1	1	87.1	17.3	BGE
SMCJ58CA00SBGG	58	64.4	71.2	1	1	93.6	16.1	BGG
SMCJ60CA00SBGK	60	66.7	73.7	1	1	96.8	15.5	BGK
SMCJ64CA00SBGM	64	71.1	78.6	1	1	103	14.6	BGM
SMCJ70CA00SBGP	70	77.8	86	1	1	113	13.3	BGP
SMCJ75CA00SBGR	75	83.3	92.1	1	1	121	12.4	BGR
SMCJ78CA00SBGT	78	86.7	95.8	1	1	126	11.9	BGT
SMCJ85CA00SBGV	85	94.4	104	1	1	137	11.0	BGV
SMCJ90CA00SBGX	90	100	111	1	1	146	10.3	BGX
SMCJ100CA00SBGZ	100	111	123	1	1	162	9.3	BGZ

SMD TRANSIENT VOLTAGE SUPPRESSORS DIODES SMCJ SERIES

BIDIRECTIONAL TYPE- ELECTRICAL CHARACTERISTICS - Ta = 25°C

Table 6

Part Code	Reverse Stand-off Voltage	Breakdown Voltage		Test Current	Reverse Leakage Max.	Max. Clamp Voltage	Peak Pulse Current	Marking Code
		V BR @ I T						
	V RMV	Min	Max	I T	I R @ V RWM	V C @ I PPM	I PPM	
	V	V	V	mA	µA	V	A	
SMCJ110CA0SBHE	110	122	135	1	1	177	8.5	BHE
SMCJ120CA0SBHG	120	133	147	1	1	193	7.8	BHG
SMCJ130CA0SBHK	130	144	159	1	1	209	7.2	BHK
SMCJ150CA0SBHM	150	167	185	1	1	243	6.2	BHM
SMCJ160CA0SBHP	160	178	197	1	1	259	5.8	BHP
SMCJ170CA0SBHR	170	189	209	1	1	275	5.5	BHR
SMCJ180CA0SBHT	180	201	222	1	1	292	5.1	BHT
SMCJ190CA0SBHU	190	211	232	1	1	308	4.8	BHU
SMCJ200CA0SBHV	200	224	247	1	1	324	4.6	BHV
SMCJ210CA0SBHW	210	237	263	1	1	340	4.4	BHW
SMCJ220CA0SBHX	220	246	272	1	1	356	4.2	BHX
SMCJ250CA0SBHZ	250	279	309	1	1	405	3.7	BHZ
SMCJ300CA0SBJE	300	335	371	1	1	486	3.1	BJE
SMCJ350CA0SBJG	350	391	432	1	1	567	2.6	BJG
SMCJ400CA0SBJK	400	447	494	1	1	648	2.3	BJK
SMCJ440CA0SBJM	440	492	543	1	1	713	2.1	BJM

SMD TRANSIENT VOLTAGE SUPPRESSORS DIODES SMCJ SERIES

RATINGS AND CHARACTERISTIC CURVES (For Reference Only)

Figure 1. Peak Pulse Power Rating Curve

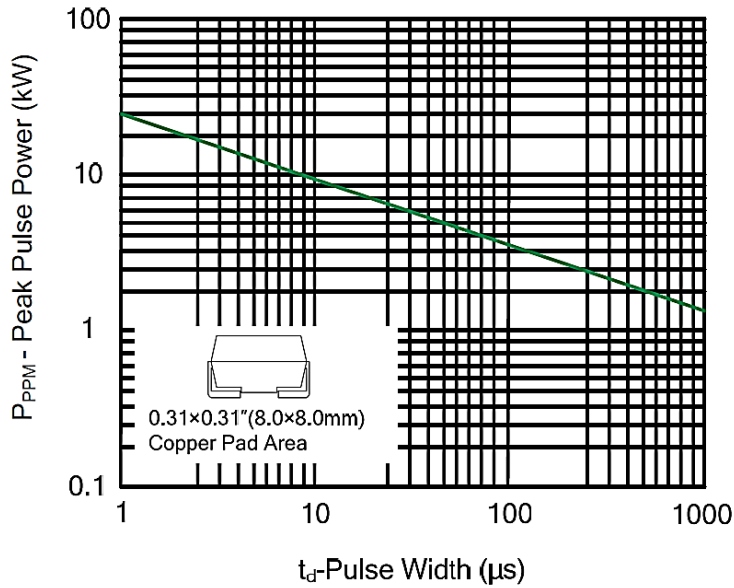
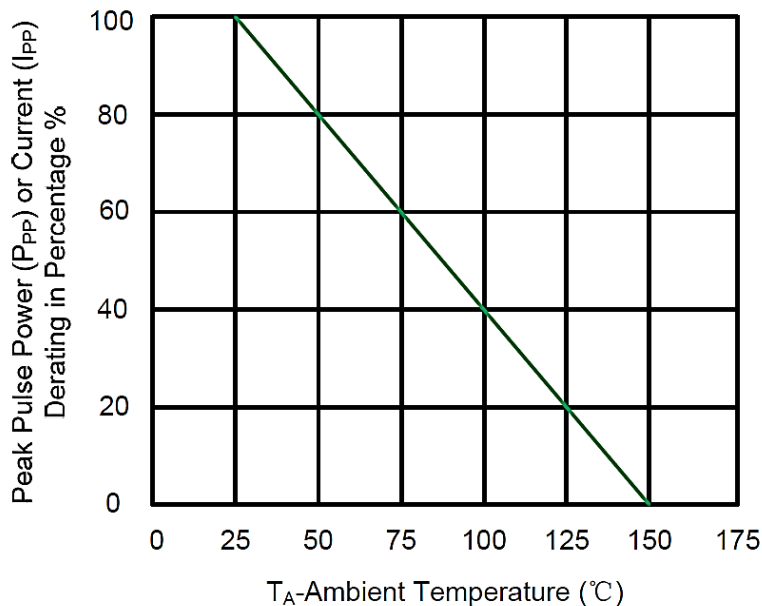

Figure 2. Pulse Derating Curve



SMD TRANSIENT VOLTAGE SUPPRESSORS DIODES SMCJ SERIES

RATINGS AND CHARACTERISTIC CURVES (For Reference Only)

Figure 3. Pulse Waveform

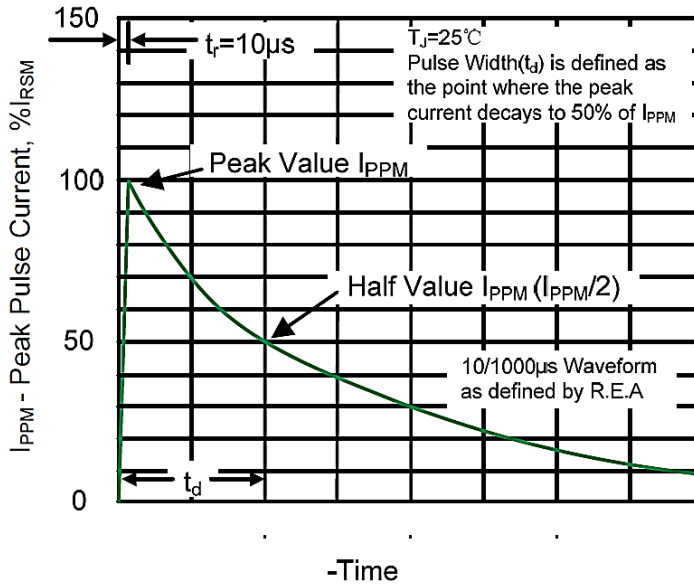
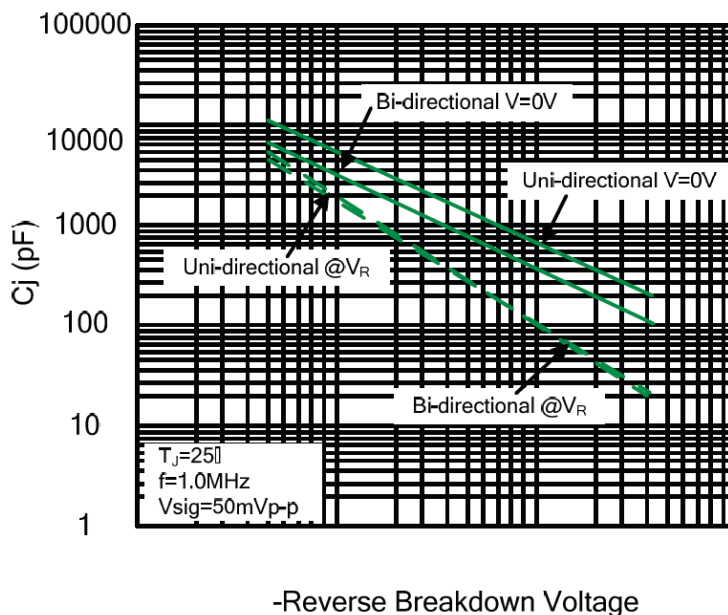

Figure 4. Typical Junction Capacitance



SMD TRANSIENT VOLTAGE SUPPRESSORS DIODES SMCJ SERIES

RATINGS AND CHARACTERISTIC CURVES (For Reference Only)

Figure 5. Steady State Power Dissipation Derating curve

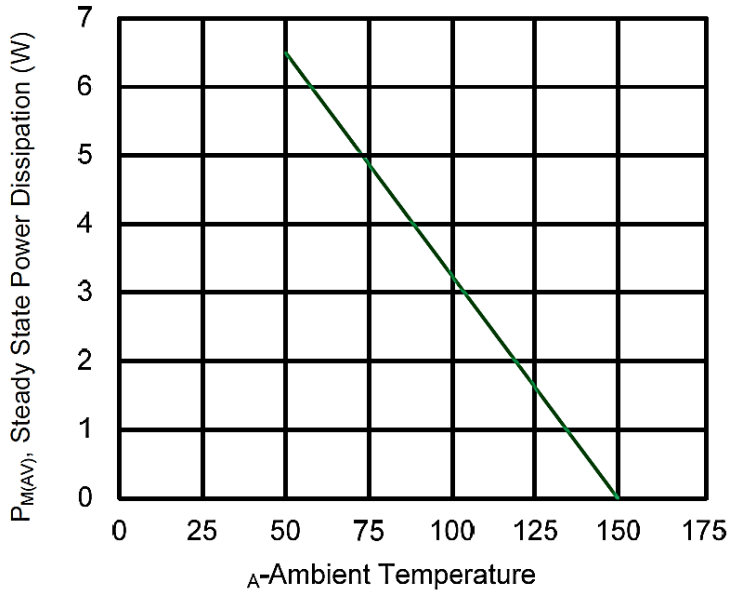
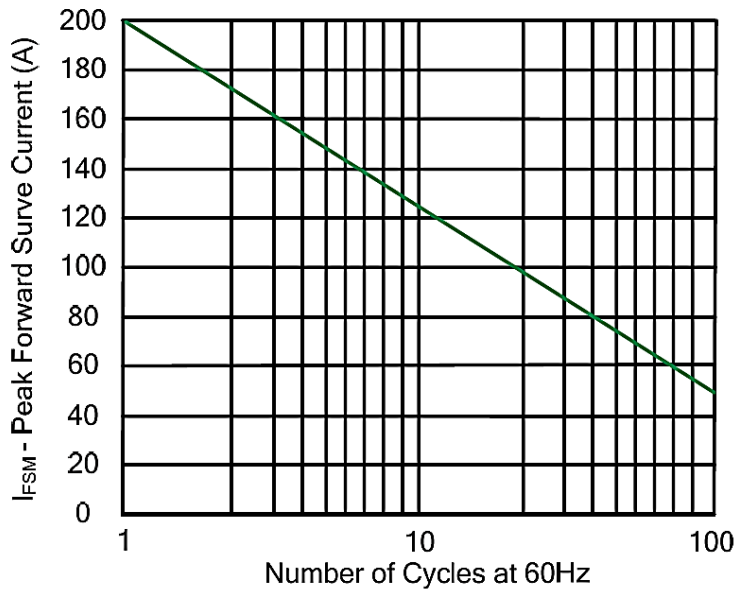

Figure 6. Maximum Non-Repetitive Forward Surge Current Uni-Directional Only



SMD TRANSIENT VOLTAGE SUPPRESSORS DIODES SMCJ SERIES

SUGGESTED REFLOW PROFILE (For Reference Only)



PROFILE FEATURE		PB-FREE ASSEMBLY
Average Ramp-up Rate (Ts Max to Tp)		3°C/second Max
Preheat	Temperature Min (Ts Min.)	150°C
	Temperature Max (Ts Max.)	200°C
	Time (ts Min. to ts Max.)	60 ~ 180 seconds
Time maintained above	Temperature (Tl)	217°C
	Time (tl)	60 ~ 150 seconds
Peak/Classification Temperature (Tp)		260 °C
Time within 5°C of actual Peak Temperature (tp)		20 ~ 40 seconds
Ramp-down rate		6 °C /Second Max.
Time 25 °C to Peak Temperature		8 minutes Max.
Suggest reflow times		3 Times Max.

SMD TRANSIENT VOLTAGE SUPPRESSORS DIODES SMCJ SERIES

RELIABILITY

NUMBER	EXPERIMENT ITEMS	EXPERIMENT METHOD AND CONDITIONS	REFERENCE DOCUMENTS
1	Solder Resistance Test	Test 260°C± 5°C for 10 ± 2 sec. Immerse body into solder 1/16" ± 1/32"	MIL-STD-750D METHOD-2031.2
2	Solderability Test	230°C ±5°C for 5 sec.	MIL-STD-750D METHOD-2026.1 0
3	Pull Test	1 kg in axial lead direction for 10 sec.	MIL-STD-750D METHOD-2036.4
4	Bend Test	0.5Kg Weight Applied To Each Lead, Bending Arcs 90 °C ± 5 °C For 3 Times	MIL-STD-750D METHOD-2036.4
5	High Temperature Reverse Bias Test	TA=100°C for 1000 Hours at VR=80% Rated VR	MIL-STD-750D METHOD-1038.4
6	Forward Operation Life Test	TA=25°C Rated Average Rectified Current	MIL-STD-750D METHOD-1027.3
7	Intermittent Operation Life Test	On state: 5 min with rated IRMS Power Off state: 5 min with Cool Forced Air. On and off for 1000 cycles.	MIL-STD-750D METHOD-1036.3
8	Pressure Cooker Test	15 PSIG, TA=121°C, 4 hours	MIL-S-19500 APPENOIXC
9	Temperature Cycling Test	-55°C~+125°C; 30 Minutes For Dwelled Time 5 minutes for transferred time. Total: 10 cycles.	MIL-STD-750D METHOD-1051.7
10	Thermal Shock Test	0°C for 5 minutes., 100°C for 5minutes, Total: 10 cycles	MIL-STD-750D METHOD-1056.7
11	Forward Surge Test	8.3ms Single Sale Sine-wave One Surge.	MIL-STD-750D METHOD-4066.4
12	Humidity Test	TA=65°C, RH=98% for 1000 hours.	MIL-STD-750D METHOD-1021.3
13	High Temperature Storage life Test	150°C for 1000 Hours	MIL-STD-750D METHOD-1031.5

SMD TRANSIENT VOLTAGE SUPPRESSORS DIODES SMCJ SERIES

TAPE/REEL (Unit: mm)

All Devices are packed in accordance with 12mm tape and Component Space 4mm EIA standard RS-481-A and specifications.

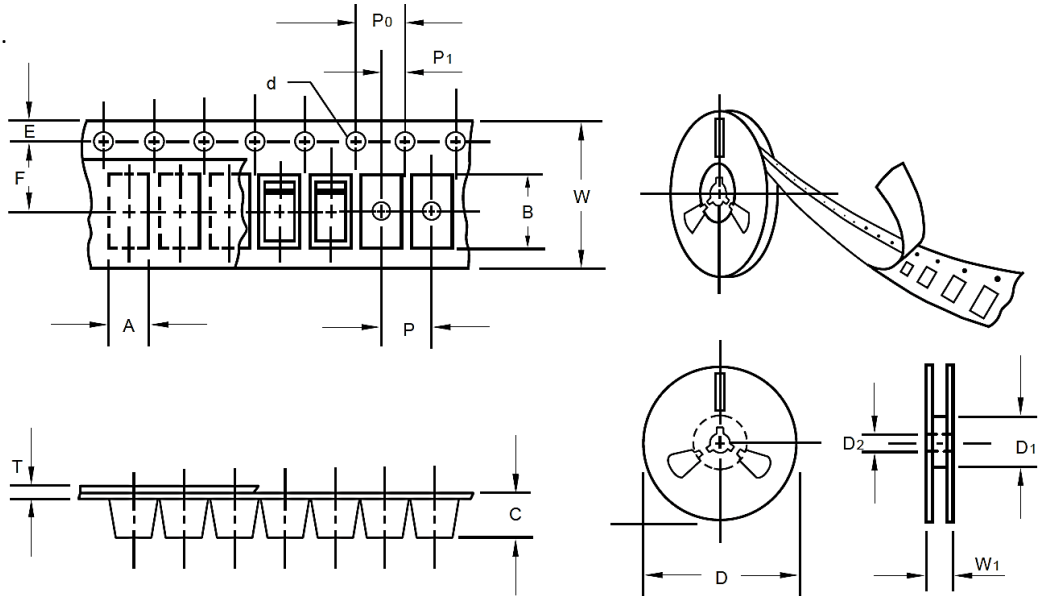

ITEM	SYMBOL	TOLERANCE	SMC/DO-214AB
Carrier width	A	0.1	6.15
Carrier Length	B	0.1	8.41
Carrier Depth	C	0.1	2.42
Sprocket hole	d	0.05	1.50
7"Reel outside diameter	D	2.0	330.00
7"Reel inner diameter	D1	Min.	50.00
Feed hole diameter	D2	0.5	13.00
Sprocket hole position	E	0.1	1.75
Punch hole position	F	0.1	7.50
Punch hole pitch	P	0.1	8.00
Sprocket hole pitch	P0	0.1	4.00
Embossment center	P1	0.1	2.00
Overall tape thickness	T	0.1	0.25
Tape width	W	0.3	16.00
Reel width	W1	1.0	16.50
Package	3000pcs/Reel, 2 Reels/ Box		
G.W/Box	6 LB		

SMD TRANSIENT VOLTAGE SUPPRESSORS DIODES SMCJ

IMPORTANT NOTES AND DISCLAIMER

1. RoHS Compliance: The levels of RoHS restricted materials in this product are below the maximum concentration values (also referred to as the threshold limits) permitted for such substances, or are used in an exempted application, in accordance with EU RoHS Directive (EU) 2015/863 EC (RoHS3). RoHS Test Report for this product can be obtained at Download Center.
2. REACH Compliance: REACH substances of high concern (SVHCs) information is available for this product. Since the European Chemical Agency (ECHA) has published notice of their intent to frequently revise the SVHC listing for the foreseeable future, REACH Test Report for this product can be obtained at Download Center.
3. All Product parametric performance is indicated in the Electrical Characteristics for the listed herein test conditions, unless otherwise noted. Product performance may not be indicated by the Electrical Characteristics if operated under different conditions.
4. NextGen Component, Inc (*NextGen*) reserves the right to make changes to this document and its products and specifications at any time without notice. Customers should obtain and confirm the latest product information and specifications before final design, purchase or use.
5. *NextGen* makes no warranty, representation or guarantee regarding the suitability of its products for any particular purpose, not does NextGen assume any liability for application assistance or customer product design.
6. *NextGen* does not warrant or accept any liability with products which are purchased or used for any unintended or unauthorized application. No license is granted by implication or otherwise under any intellectual property rights of *NextGen*.
7. *NextGen* products are not authorized for use as critical components in life support devices or systems without express written approval by *NextGen*.
8. *NextGen* requires that customers first obtain an RMA (Returned Merchandise Authorization) number prior to returning any products. Returns must be made within 30 days of the date of invoice, be in the original packaging, unused and like-new condition. At the time of quoting or purchasing, a product may say that it is Non-Cancelable/ Non-Returnable (NCNR). These products are not returnable and not refundable.