



|   |  |                               |
|---|--|-------------------------------|
| <b>DATA SHEET NO.</b>                   | R0419 - SMF40A0000S40A   |                               |
| <b>DATE</b>                             | Apr.19, 2024   |                               |
| <b>REVISION</b>                         | A3   | Updated With Most Recent Data |
| <b>DESCRIPTION AND MAIN PARAMETRICS</b> | <p>SMD Transient Voltage Suppressor (TVs) Diodes, SMF/SOD-123FL series,<br/>                 2 Pads, Unidirectional Type, Stand-off Voltage 40V,<br/>                 Peak Pulse Power: 200 Watts, Peak Pulse Current: 3.1A Max.<br/>                 Operating Temp. Range -55°C ~+150°C<br/>                 Package in Tape/Reel, 3000pcs/Reel<br/>                 REACH/RoHS/RoHS III Compliant</p> |                               |
| <b>CUSTOMER</b>                         |  |                               |
| <b>CUSTOMER PART NO.</b>                |  |                               |
| <b>CROSS REF. PART NO.</b>              |  |                               |
| <b>ORIGINAL MFG/PART NO</b>             | MDD SMF40A   |                               |
| <b>PART CODE</b>                        | SMF40A0000S40A   |                               |

|                         |   |  |   |
|-------------------------|---|--|---|
| <b>VENDOR APPROVE</b>   |   |  |   |
| Issued/Checked/Approved |  |  |  |
| DATE: Apr. 19, 2024     |   |  |   |

|                         |  |
|-------------------------|--|
| <b>CUSTOMER APPROVE</b> |  |
|                         |  |
| DATE:                   |  |

**SMD TRANSIENT VOLTAGE SUPPRESSORS DIODES SMF SERIES**

**MAIN FEATURE**

- Low Profile Package
- Glass Passivated Chip Junction
- Low Inductance
- Plastic Package Has Underwriters Laboratory Flammability



**APPLICATION**

- For SMD application

**ELECTRICAL CHARACTERISTICS**

- See Page 4~ Page 10

**HOW TO ORDER**

- Please Follow Up Part Code Guide And Indicate Pat Code When You Order or RFQ

**PART CODE GUIDE**

**RFQ**  
Request For Quotation

|     |     |       |     |
|-----|-----|-------|-----|
| SMF | 40A | 0000S | 40A |
| 1   | 2   | 3     | 4   |

1. SMF: SMD Transient Voltage Suppressor (TVs) Diodes, SMF/SOD-123FL series
2. 40A: Unidirectional Type, Stand-off Voltage: 40V
3. 0000S: Internal Control Code or Special Parameters Code, Letter A~Z, a~z or digits 0~9
4. 40A: Marking code "40A" on the case surface.

**SMD TRANSIENT VOLTAGE SUPPRESSORS DIODES SMF SERIES**

**DIMENSION** (Unit: Inch/mm)

Image for reference



Marking:

See Page 5~ Page 10

Marking Code List

SMF/SOD-123FL



Recommend Pad Layout

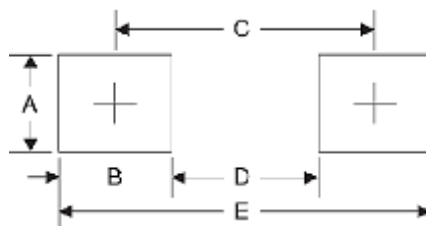

| Symbol | Unit (Inch) | Unit (mm) |
|--------|-------------|-----------|
| A      | 0.047       | 1.20      |
| B      | 0.047       | 1.20      |
| C      | 0.126       | 3.20      |
| D      | 0.079       | 2.00      |
| E      | 0.173       | 4.40      |

**SMD TRANSIENT VOLTAGE SUPPRESSORS DIODES SMF SERIES**
**MECHANICAL DATA**

| CASE  | TERMINALS   | POLARITY                                 | MOUNTING POSITION | MARKING                     | WEIGHT PER PIECE                 |
|---|---|--|-------------------|-----------------------------|----------------------------------|
| JEDEC<br>SMF/SOD-123FL<br>molded plastic body | Solderable per<br>MIL-STD-<br>750, Method<br>2026 | Polarity<br>symbol<br>marking on<br>body | Any               | See<br>Marking Code<br>List | 0.00048<br>ounce, 0.015<br>grams |

**MAX. RATING & CHARACTERISTICS** - Ratings at 25°C Ambient Temperature Unless Otherwise Specified.

| PARAMETER   | SYMBOLS     | VALUE                  | UNITS |
|---|-------------|------------------------|-------|
| Peak Pulse Power Dissipation on TA=25°C (Note 1,2,5 Fig 1)        | P ppm       | 200                    | W     |
| Peak Forward Surge Current 8.3ms Single Half Sine Wave (Note 3) - | I FSM (UNI) | 20                     | A     |
| Steady State Power Dissipation (Note 4)                           | P M(AV)     | 1.0                    | W     |
| Peak Pulse Current on 10/1000 us waveform (Note 1) Fig 2          | I PPM       | See<br>Table 1~Table 6 | A     |
| Operating junction temperature range                              | T J         | -55 ~ +150             | °C    |
| Storage temperature range   | T stg       | -55 ~ +150             | °C    |
| Typical Thermal Resistance  | R θJA       | 180                    | °C/W  |

**Note**

1. Non-repetitive current pulse, per Fig 3 and derated above TA=25 °C per Fig 2
2. Mounted on 5.0\*5.0mm copper pads to each terminal
3. 8.3ms single half sinewave or equivalent square wave, duty cycle=4 pulsed per minute Max.
4. Lead temperature at T L =75 °C
5. Peak pulse power waveform is tp =10/1000µs
6. A transient suppressor is selected according to the working peak reverse voltage (V RWM), which should be equal to or great than the DC or continuous peak operating voltage level.

**SMD TRANSIENT VOLTAGE SUPPRESSORS DIODES SMF SERIES**
**UNIDIRECTIONAL TYPE- ELECTRICAL CHARACTERISTICS - Ta = 25°C**

Table 1

| Part Code      | Reverse Stand-off Voltage | Breakdown Voltage                |      | Test Current   | Reverse Leakage Max.              | Max. Clamp Voltage                | Peak Pulse Current | Marking Code |
|----------------|---------------------------|----------------------------------|------|----------------|-----------------------------------|-----------------------------------|--------------------|--------------|
|                |                           | V <sub>BR</sub> @ I <sub>T</sub> |      |                |                                   |                                   |                    |              |
|                | V <sub>RMV</sub>          | Min                              | Max  | I <sub>T</sub> | I <sub>R</sub> @ V <sub>RWM</sub> | V <sub>C</sub> @ I <sub>PPM</sub> | I <sub>PPM</sub>   |              |
|                | V                         | V                                | V    | mA             | µA                                | V                                 | A                  |              |
| SMF050A00S050A | 5                         | 6.4                              | 7    | 10             | 400                               | 9.2                               | 21.7               | 5.0A         |
| SMF060A00S060A | 6                         | 6.67                             | 7.37 | 10             | 400                               | 10.3                              | 19.4               | 6.0A         |
| SMF065A00S065A | 6.5                       | 7.22                             | 7.98 | 10             | 250                               | 11.2                              | 17.9               | 6.5A         |
| SMF070A00S070A | 7                         | 7.78                             | 8.6  | 10             | 100                               | 12                                | 16.7               | 7.0A         |
| SMF075A00S075A | 7.5                       | 8.33                             | 9.2  | 1              | 50                                | 12.9                              | 15.5               | 7.5A         |
| SMF080A00S080A | 8                         | 8.89                             | 9.83 | 1              | 25                                | 13.6                              | 14.7               | 8.0A         |
| SMF085A00S085A | 8.5                       | 9.44                             | 10.4 | 1              | 10                                | 14.4                              | 13.9               | 8.5A         |
| SMF090A00S090A | 9                         | 10                               | 11.1 | 1              | 5                                 | 15.4                              | 13                 | 9.0A         |
| SMF10A0000S10A | 10                        | 11.1                             | 12.3 | 1              | 2.5                               | 17                                | 11.8               | 10A          |
| SMF11A0000S11A | 11                        | 12.2                             | 13.5 | 1              | 2.5                               | 18.2                              | 11                 | 11A          |
| SMF12A0000S12A | 12                        | 13.3                             | 14.7 | 1              | 2.5                               | 19.9                              | 10.1               | 12A          |
| SMF13A0000S13A | 13                        | 14.4                             | 15.9 | 1              | 1                                 | 21.5                              | 9.3                | 13A          |
| SMF14A0000S14A | 14                        | 15.6                             | 17.2 | 1              | 1                                 | 23.2                              | 8.6                | 14A          |
| SMF15A0000S15A | 15                        | 16.7                             | 18.5 | 1              | 1                                 | 24.4                              | 8.2                | 15A          |
| SMF16A0000S16A | 16                        | 17.8                             | 19.7 | 1              | 1                                 | 26                                | 7.7                | 16A          |
| SMF17A0000S17A | 17                        | 18.9                             | 20.9 | 1              | 1                                 | 27.6                              | 7.2                | 17A          |
| SMF18A0000S18A | 18                        | 20                               | 22.1 | 1              | 1                                 | 29.2                              | 6.8                | 18A          |
| SMF20A0000S20A | 20                        | 22.2                             | 24.5 | 1              | 1                                 | 32.4                              | 6.2                | 20A          |
| SMF22A0000S22A | 22                        | 24.4                             | 26.9 | 1              | 1                                 | 35.5                              | 5.6                | 22A          |
| SMF24A0000S24A | 24                        | 26.7                             | 29.5 | 1              | 1                                 | 38.9                              | 5.1                | 24A          |

**SMD TRANSIENT VOLTAGE SUPPRESSORS DIODES SMF SERIES**
**UNIDIRECTIONAL TYPE- ELECTRICAL CHARACTERISTICS - Ta = 25°C**

Table 2

| Part Code             | Reverse Stand-off Voltage | Breakdown Voltage |             | Test Current | Reverse Leakage Max. | Max. Clamp Voltage | Peak Pulse Current | Marking Code |
|-----------------------|---------------------------|-------------------|-------------|--------------|----------------------|--------------------|--------------------|--------------|
|                       |                           | V BR @ I T        |             |              |                      |                    |                    |              |
|                       | V RMV                     | Min               | Max         | I T          | I R @ V RWM          | V C @ I PPM        | I PPM              |              |
|                       | V                         | V                 | V           | mA           | µA                   | V                  | A                  |              |
| SMF26A0000S26A        | 26                        | 28.9              | 31.9        | 1            | 1                    | 42.1               | 4.8                | 26A          |
| SMF28A0000S28A        | 28                        | 31.1              | 34.4        | 1            | 1                    | 45.4               | 4.4                | 28A          |
| SMF30A0000S30A        | 30                        | 33.3              | 36.8        | 1            | 1                    | 48.4               | 4.1                | 30A          |
| SMF33A0000S33A        | 33                        | 36.7              | 40.6        | 1            | 1                    | 53.3               | 3.8                | 33A          |
| SMF36A0000S36A        | 36                        | 40                | 44.2        | 1            | 1                    | 58.1               | 3.4                | 36A          |
| <b>SMF40A0000S40A</b> | <b>40</b>                 | <b>44.4</b>       | <b>49.1</b> | <b>1</b>     | <b>1</b>             | <b>64.5</b>        | <b>3.1</b>         | <b>40A</b>   |
| SMF43A0000S43A        | 43                        | 47.8              | 52.8        | 1            | 1                    | 69.4               | 2.9                | 43A          |
| SMF45A0000S45A        | 45                        | 50                | 55.3        | 1            | 1                    | 72.7               | 2.8                | 45A          |
| SMF48A0000S48A        | 48                        | 53.3              | 58.9        | 1            | 1                    | 77.4               | 2.6                | 48A          |
| SMF51A0000S51A        | 51                        | 56.7              | 62.7        | 1            | 1                    | 82.4               | 2.4                | 51A          |
| SMF54A0000S54A        | 54                        | 60                | 66.3        | 1            | 1                    | 87.1               | 2.3                | 54A          |
| SMF58A0000S58A        | 58                        | 64.4              | 71.2        | 1            | 1                    | 93.6               | 2.1                | 58A          |
| SMF60A0000S60A        | 60                        | 66.7              | 73.7        | 1            | 1                    | 96.8               | 1.8                | 60A          |
| SMF64A0000S64A        | 64                        | 71.1              | 78.6        | 1            | 1                    | 103                | 1.7                | 64A          |
| SMF70A0000S70A        | 70                        | 77.8              | 86          | 1            | 1                    | 113                | 1.5                | 70A          |
| SMF75A0000S75A        | 75                        | 83.3              | 92.1        | 1            | 1                    | 121                | 1.4                | 75A          |
| SMF78A0000S78A        | 78                        | 86.7              | 95.8        | 1            | 1                    | 126                | 1.4                | 78A          |
| SMF85A0000S85A        | 85                        | 94.4              | 104         | 1            | 1                    | 137                | 1.3                | 85A          |
| SMF90A0000S90A        | 90                        | 100               | 111         | 1            | 1                    | 146                | 1.2                | 90A          |
| SMF100A0000S100A      | 100                       | 111               | 123         | 1            | 1                    | 162                | 1.1                | 100A         |

**SMD TRANSIENT VOLTAGE SUPPRESSORS DIODES SMF SERIES**
**UNIDIRECTIONAL TYPE- ELECTRICAL CHARACTERISTICS - Ta = 25°C**

Table 3

| Part Code      | Reverse Stand-off Voltage | Breakdown Voltage                |     | Test Current   | Reverse Leakage Max.              | Max. Clamp Voltage                | Peak Pulse Current | Marking Code |
|----------------|---------------------------|----------------------------------|-----|----------------|-----------------------------------|-----------------------------------|--------------------|--------------|
|                |                           | V <sub>BR</sub> @ I <sub>T</sub> |     |                |                                   |                                   |                    |              |
|                | V <sub>RMV</sub>          | Min                              | Max | I <sub>T</sub> | I <sub>R</sub> @ V <sub>RWM</sub> | V <sub>C</sub> @ I <sub>PPM</sub> | I <sub>PPM</sub>   |              |
|                | V                         | V                                | V   | mA             | µA                                | V                                 | A                  |              |
| SMF110A00S110A | 110                       | 122                              | 135 | 1              | 1                                 | 177                               | 1                  | 110A         |
| SMF120A00S120A | 120                       | 133                              | 147 | 1              | 1                                 | 193                               | 0.9                | 120A         |
| SMF130A00S130A | 130                       | 144                              | 159 | 1              | 1                                 | 209                               | 0.8                | 130A         |
| SMF150A00S150A | 150                       | 167                              | 185 | 1              | 1                                 | 243                               | 0.7                | 150A         |
| SMF160A00S160A | 160                       | 178                              | 197 | 1              | 1                                 | 259                               | 0.7                | 160A         |
| SMF170A00S170A | 170                       | 189                              | 209 | 1              | 1                                 | 275                               | 0.6                | 170A         |
| SMF180A00S180A | 180                       | 201                              | 222 | 1              | 1                                 | 292                               | 0.5                | 180A         |
| SMF190A00S190A | 190                       | 211                              | 232 | 1              | 1                                 | 308                               | 0.5                | 190A         |
| SMF200A00S200A | 200                       | 224                              | 247 | 1              | 1                                 | 324                               | 0.5                | 200A         |
| SMF220A00S220A | 220                       | 246                              | 272 | 1              | 1                                 | 356                               | 0.5                | 220A         |
| SMF250A00S250A | 250                       | 279                              | 309 | 1              | 1                                 | 405                               | 0.5                | 250A         |
| SMF300A00S300A | 300                       | 335                              | 371 | 1              | 1                                 | 486                               | 0.45               | 300A         |
| SMF350A00S350A | 350                       | 391                              | 432 | 1              | 1                                 | 567                               | 0.4                | 350A         |
| SMF400A00S400A | 400                       | 447                              | 494 | 1              | 1                                 | 648                               | 0.35               | 400A         |
| SMF440A00S440A | 440                       | 492                              | 543 | 1              | 1                                 | 713                               | 0.3                | 440A         |

**SMD TRANSIENT VOLTAGE SUPPRESSORS DIODES SMF SERIES**
**BIDIRECTIONAL TYPE- ELECTRICAL CHARACTERISTICS - Ta = 25°C**

Table 4

| Part Code      | Reverse Stand-off Voltage | Breakdown Voltage                |      | Test Current   | Reverse Leakage Max.              | Max. Clamp Voltage                | Peak Pulse Current | Marking Code |
|----------------|---------------------------|----------------------------------|------|----------------|-----------------------------------|-----------------------------------|--------------------|--------------|
|                |                           | V <sub>BR</sub> @ I <sub>T</sub> |      |                |                                   |                                   |                    |              |
|                | V <sub>RMV</sub>          | Min                              | Max  | I <sub>T</sub> | I <sub>R</sub> @ V <sub>RWM</sub> | V <sub>C</sub> @ I <sub>PPM</sub> | I <sub>PPM</sub>   |              |
| V              | V                         | V                                | mA   | µA             | V                                 | A                                 |                    |              |
| SMF050CAS050CA | 5                         | 6.4                              | 7    | 10             | 400                               | 9.2                               | 21.7               | 5.0CA        |
| SMF060CAS060CA | 6                         | 6.67                             | 7.37 | 10             | 400                               | 10.3                              | 19.4               | 6.0CA        |
| SMF065CAS065CA | 6.5                       | 7.22                             | 7.98 | 10             | 250                               | 11.2                              | 17.9               | 6.5CA        |
| SMF070CAS070CA | 7                         | 7.78                             | 8.6  | 10             | 100                               | 12                                | 16.7               | 7.0CA        |
| SMF075CAS075CA | 7.5                       | 8.33                             | 9.2  | 1              | 50                                | 12.9                              | 15.5               | 7.5CA        |
| SMF080CAS080CA | 8                         | 8.89                             | 9.83 | 1              | 25                                | 13.6                              | 14.7               | 8.0CA        |
| SMF085CAS085CA | 8.5                       | 9.44                             | 10.4 | 1              | 10                                | 14.4                              | 13.9               | 8.5CA        |
| SMF090CAS090CA | 9                         | 10                               | 11.1 | 1              | 5                                 | 15.4                              | 13                 | 9.0CA        |
| SMF10CA00S10CA | 10                        | 11.1                             | 12.3 | 1              | 2.5                               | 17                                | 11.8               | 10CA         |
| SMF11CA00S11CA | 11                        | 12.2                             | 13.5 | 1              | 2.5                               | 18.2                              | 11                 | 11CA         |
| SMF12CA00S12CA | 12                        | 13.3                             | 14.7 | 1              | 2.5                               | 19.9                              | 10.1               | 12CA         |
| SMF13CA00S13CA | 13                        | 14.4                             | 15.9 | 1              | 1                                 | 21.5                              | 9.3                | 13CA         |
| SMF14CA00S14CA | 14                        | 15.6                             | 17.2 | 1              | 1                                 | 23.2                              | 8.6                | 14CA         |
| SMF15CA00S15CA | 15                        | 16.7                             | 18.5 | 1              | 1                                 | 24.4                              | 8.2                | 15CA         |
| SMF16CA00S16CA | 16                        | 17.8                             | 19.7 | 1              | 1                                 | 26                                | 7.7                | 16CA         |
| SMF17CA00S17CA | 17                        | 18.9                             | 20.9 | 1              | 1                                 | 27.6                              | 7.2                | 17CA         |
| SMF18CA00S18CA | 18                        | 20                               | 22.1 | 1              | 1                                 | 29.2                              | 6.8                | 18CA         |
| SMF20CA00S20CA | 20                        | 22.2                             | 24.5 | 1              | 1                                 | 32.4                              | 6.2                | 20CA         |
| SMF22CA00S22CA | 22                        | 24.4                             | 26.9 | 1              | 1                                 | 35.5                              | 5.6                | 22CA         |
| SMF24CA00S24CA | 24                        | 26.7                             | 29.5 | 1              | 1                                 | 38.9                              | 5.1                | 24CA         |



**SMD TRANSIENT VOLTAGE SUPPRESSORS DIODES SMF SERIES**
**BIDIRECTIONAL TYPE- ELECTRICAL CHARACTERISTICS - Ta = 25°C**

Table 5

| Part Code      | Reverse Stand-off Voltage | Breakdown Voltage                |      | Test Current   | Reverse Leakage Max.              | Max. Clamp Voltage                | Peak Pulse Current | Marking Code |
|----------------|---------------------------|----------------------------------|------|----------------|-----------------------------------|-----------------------------------|--------------------|--------------|
|                |                           | V <sub>BR</sub> @ I <sub>T</sub> |      |                |                                   |                                   |                    |              |
|                | V <sub>RMV</sub>          | Min                              | Max  | I <sub>T</sub> | I <sub>R</sub> @ V <sub>RWM</sub> | V <sub>C</sub> @ I <sub>PPM</sub> | I <sub>PPM</sub>   |              |
|                | V                         | V                                | V    | mA             | µA                                | V                                 | A                  |              |
| SMF26CA00S26CA | 26                        | 28.9                             | 31.9 | 1              | 1                                 | 42.1                              | 4.8                | 26CA         |
| SMF28CA00S28CA | 28                        | 31.1                             | 34.4 | 1              | 1                                 | 45.4                              | 4.4                | 28CA         |
| SMF30CA00S30CA | 30                        | 33.3                             | 36.8 | 1              | 1                                 | 48.4                              | 4.1                | 30CA         |
| SMF33CA00S33CA | 33                        | 36.7                             | 40.6 | 1              | 1                                 | 53.3                              | 3.8                | 33CA         |
| SMF36CA00S36CA | 36                        | 40                               | 44.2 | 1              | 1                                 | 58.1                              | 3.4                | 36CA         |
| SMF40CA00S40CA | 40                        | 44.4                             | 49.1 | 1              | 1                                 | 64.5                              | 3.1                | 40CA         |
| SMF43CA00S43CA | 43                        | 47.8                             | 52.8 | 1              | 1                                 | 69.4                              | 2.9                | 43CA         |
| SMF45CA00S45CA | 45                        | 50                               | 55.3 | 1              | 1                                 | 72.7                              | 2.8                | 45CA         |
| SMF48CA00S48CA | 48                        | 53.3                             | 58.9 | 1              | 1                                 | 77.4                              | 2.6                | 48CA         |
| SMF51CA00S51CA | 51                        | 56.7                             | 62.7 | 1              | 1                                 | 82.4                              | 2.4                | 51CA         |
| SMF54CA00S54CA | 54                        | 60                               | 66.3 | 1              | 1                                 | 87.1                              | 2.3                | 54CA         |
| SMF58CA00S58CA | 58                        | 64.4                             | 71.2 | 1              | 1                                 | 93.6                              | 2.1                | 58CA         |
| SMF60CA00S60CA | 60                        | 66.7                             | 73.7 | 1              | 1                                 | 96.8                              | 1.8                | 60CA         |
| SMF64CA00S64CA | 64                        | 71.1                             | 78.6 | 1              | 1                                 | 103                               | 1.7                | 64CA         |
| SMF70CA00S70CA | 70                        | 77.8                             | 86   | 1              | 1                                 | 113                               | 1.5                | 70CA         |
| SMF75CA00S75CA | 75                        | 83.3                             | 92.1 | 1              | 1                                 | 121                               | 1.4                | 75CA         |
| SMF78CA00S78CA | 78                        | 86.7                             | 95.8 | 1              | 1                                 | 126                               | 1.4                | 78CA         |
| SMF85CA00S85CA | 85                        | 94.4                             | 104  | 1              | 1                                 | 137                               | 1.3                | 85CA         |
| SMF90CA00S90CA | 90                        | 100                              | 111  | 1              | 1                                 | 146                               | 1.2                | 90CA         |
| SMF100CAS100CA | 100                       | 111                              | 123  | 1              | 1                                 | 162                               | 1.1                | 100CA        |

**SMD TRANSIENT VOLTAGE SUPPRESSORS DIODES SMF SERIES**
**BIDIRECTIONAL TYPE- ELECTRICAL CHARACTERISTICS - Ta = 25°C**

Table 6

| Part Code      | Reverse Stand-off Voltage | Breakdown Voltage                |     | Test Current   | Reverse Leakage Max.              | Max. Clamp Voltage                | Peak Pulse Current | Marking Code |
|----------------|---------------------------|----------------------------------|-----|----------------|-----------------------------------|-----------------------------------|--------------------|--------------|
|                |                           | V <sub>BR</sub> @ I <sub>T</sub> |     |                |                                   |                                   |                    |              |
|                | V <sub>RMV</sub>          | Min                              | Max | I <sub>T</sub> | I <sub>R</sub> @ V <sub>RWM</sub> | V <sub>C</sub> @ I <sub>PPM</sub> | I <sub>PPM</sub>   |              |
|                | V                         | V                                | V   | mA             | µA                                | V                                 | A                  |              |
| SMF110CAS110CA | 110                       | 122                              | 135 | 1              | 1                                 | 177                               | 1                  | 110CA        |
| SMF120CAS120CA | 120                       | 133                              | 147 | 1              | 1                                 | 193                               | 0.9                | 120CA        |
| SMF130CAS130CA | 130                       | 144                              | 159 | 1              | 1                                 | 209                               | 0.8                | 130CA        |
| SMF150CAS150CA | 150                       | 167                              | 185 | 1              | 1                                 | 243                               | 0.7                | 150CA        |
| SMF160CAS160CA | 160                       | 178                              | 197 | 1              | 1                                 | 259                               | 0.7                | 160CA        |
| SMF170CAS170CA | 170                       | 189                              | 209 | 1              | 1                                 | 275                               | 0.6                | 170CA        |
| SMF180CAS180CA | 180                       | 201                              | 222 | 1              | 1                                 | 292                               | 0.5                | 180CA        |
| SMF190CAS190CA | 190                       | 211                              | 232 | 1              | 1                                 | 308                               | 0.5                | 190CA        |
| SMF200CAS200CA | 200                       | 224                              | 247 | 1              | 1                                 | 324                               | 0.5                | 200CA        |
| SMF220CAS220CA | 220                       | 246                              | 272 | 1              | 1                                 | 356                               | 0.5                | 220CA        |
| SMF250CAS250CA | 250                       | 279                              | 309 | 1              | 1                                 | 405                               | 0.5                | 250CA        |
| SMF300CAS300CA | 300                       | 335                              | 371 | 1              | 1                                 | 486                               | 0.45               | 300CA        |
| SMF350CAS350CA | 350                       | 391                              | 432 | 1              | 1                                 | 567                               | 0.4                | 350CA        |
| SMF400CAS400CA | 400                       | 447                              | 494 | 1              | 1                                 | 648                               | 0.35               | 400CA        |
| SMF440CAS440CA | 440                       | 492                              | 543 | 1              | 1                                 | 713                               | 0.3                | 440CA        |

**SMD TRANSIENT VOLTAGE SUPPRESSORS DIODES SMF SERIES**
**RELIABILITY**

| NUMBER | EXPERIMENT ITEMS                   | EXPERIMENT METHOD AND CONDITIONS   | REFERENCE DOCUMENTS             |
|--------|------------------------------------|--|---------------------------------|
| 1      | Solder Resistance Test             | Test 260°C± 5°C for 10 ± 2 sec.<br>Immerse body into solder 1/16" ± 1/32"                                      | MIL-STD-750D<br>METHOD-2031.2   |
| 2      | Solderability Test                 | 230°C ±5°C for 5 sec.  | MIL-STD-750D<br>METHOD-2026.1 0 |
| 3      | Pull Test                          | 1 kg in axial lead direction for 10 sec.   | MIL-STD-750D<br>METHOD-2036.4   |
| 4      | Bend Test                          | 0.5Kg Weight Applied To Each Lead,<br>Bending Arcs 90 °C ± 5 °C For 3 Times                                    | MIL-STD-750D<br>METHOD-2036.4   |
| 5      | High Temperature Reverse Bias Test | TA=100°C for 1000 Hours at VR=80%<br>Rated VR  | MIL-STD-750D<br>METHOD-1038.4   |
| 6      | Forward Operation Life Test        | TA=25°C Rated Average Rectified<br>Current   | MIL-STD-750D<br>METHOD-1027.3   |
| 7      | Intermittent Operation Life Test   | On state: 5 min with rated IRMS Power<br>Off state: 5 min with Cool Forced Air.<br>On and off for 1000 cycles. | MIL-STD-750D<br>METHOD-1036.3   |
| 8      | Pressure Cooker Test               | 15 PSIG, TA=121°C, 4 hours   | MIL-S-19500<br>APPENOIXC        |
| 9      | Temperature Cycling Test           | -55°C~+125°C; 30 Minutes For Dwelled<br>Time 5 minutes for transferred time.<br>Total: 10 cycles.              | MIL-STD-750D<br>METHOD-1051.7   |
| 10     | Thermal Shock Test                 | 0°C for 5 minutes., 100°C for 5minutes,<br>Total: 10 cycles  | MIL-STD-750D<br>METHOD-1056.7   |
| 11     | Forward Surge Test                 | 8.3ms Single Sale Sine-wave One Surge.   | MIL-STD-750D<br>METHOD-4066.4   |
| 12     | Humidity Test                      | TA=65°C, RH=98% for 1000 hours.  | MIL-STD-750D<br>METHOD-1021.3   |
| 13     | High Temperature Storage life Test | 150°C for 1000 Hours   | MIL-STD-750D<br>METHOD-1031.5   |

**SMD TRANSIENT VOLTAGE SUPPRESSORS DIODES SMF SERIES**

**SUGGESTED REFLOW PROFILE (For Reference Only)**



| PROFILE FEATURE                                 |                           | PB-FREE ASSEMBLY  |
|---|---------------------------|-------------------|
| Average Ramp-up Rate (Ts Max to Tp)             |                           | 3°C/second Max    |
| Preheat   | Temperature Min (Ts Min.) | 150°C             |
|   | Temperature Max (Ts Max.) | 200°C             |
|   | Time (ts Min. to ts Max.) | 60 ~ 180 seconds  |
| Time maintained above                           | Temperature (Tl)          | 217°C             |
|   | Time (tl)                 | 60 ~ 150 seconds  |
| Peak/Classification Temperature (Tp)            |                           | 260 °C            |
| Time within 5°C of actual Peak Temperature (tp) |                           | 20 ~ 40 seconds   |
| Ramp-down rate                                  |                           | 6 °C /Second Max. |
| Time 25 °C to Peak Temperature                  |                           | 8 minutes Max.    |
| Suggest reflow times                            |                           | 3 Times Max.      |

**SMD TRANSIENT VOLTAGE SUPPRESSORS DIODES SMF SERIES**

**RATINGS AND CHARACTERISTIC CURVES** (For Reference Only)

**Fig.1 Peak Pulse Power Rating Curve**

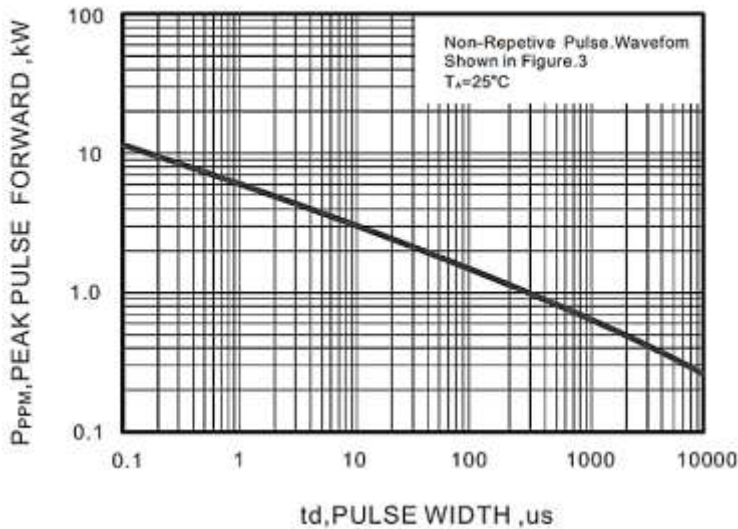

**Fig.2 Forward Current Derating Curve**

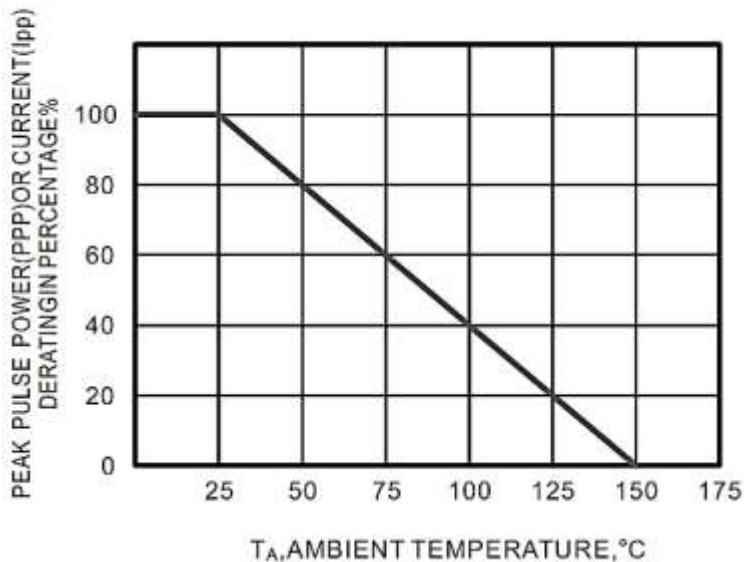

**SMD TRANSIENT VOLTAGE SUPPRESSORS DIODES SMF SERIES**

**RATINGS AND CHARACTERISTIC CURVES** (For Reference Only)

**Fig.3 Pulse Waveform**

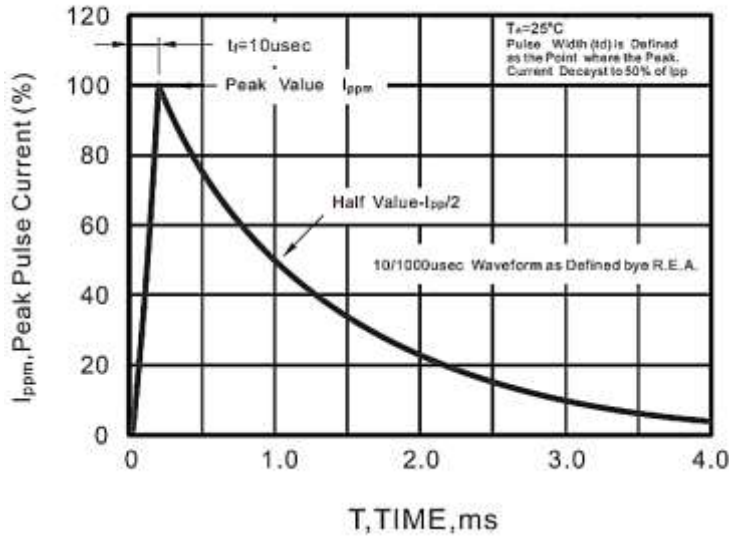

**Fig.4 Maximum Non-Repetitive Peak Forward Surge Current**

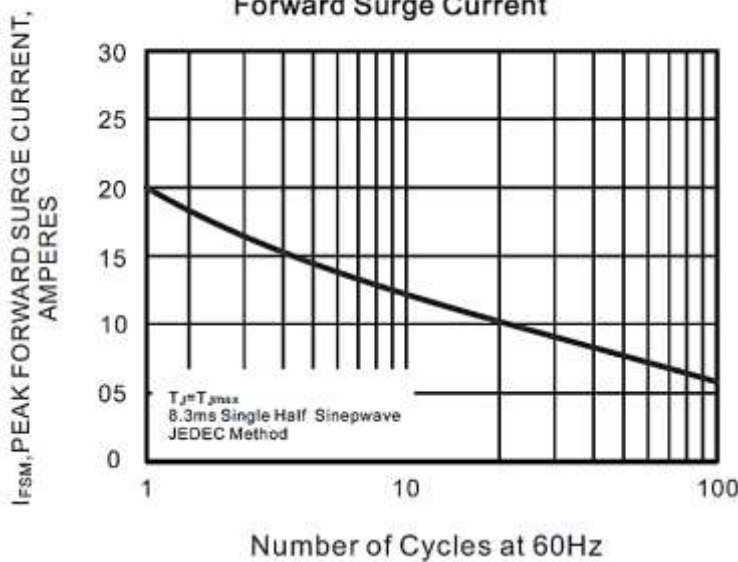

**SMD TRANSIENT VOLTAGE SUPPRESSORS DIODES SMF SERIES**

**TAPE/REEL (Unit: mm)**

All Devices are packed in accordance with EIA standard RS-481-A and specifications.

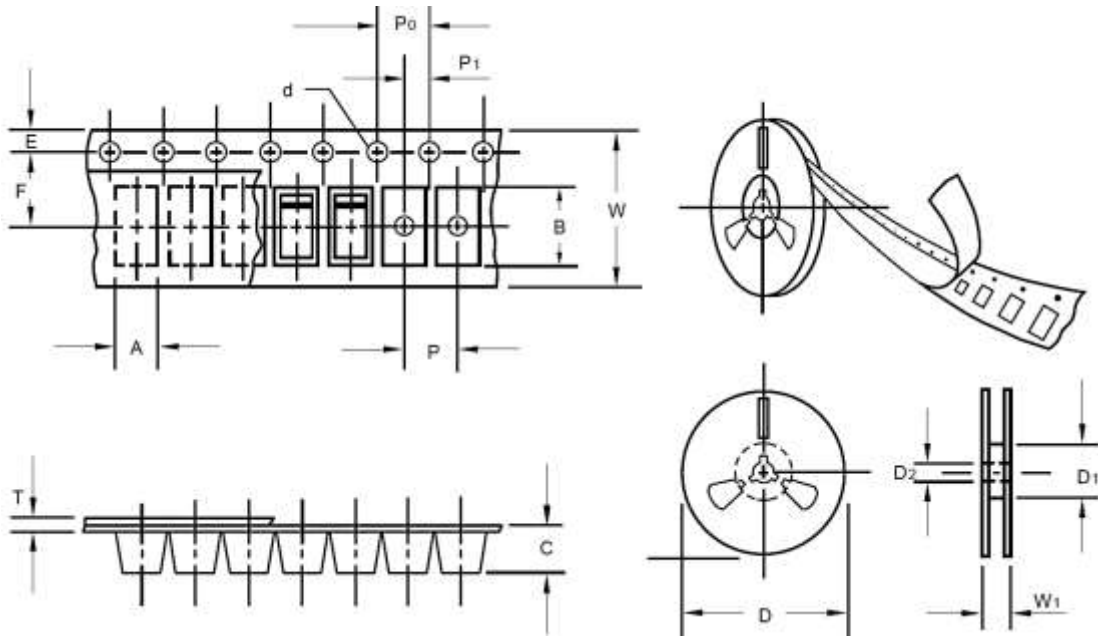

| ITEM                     | SYMBOL                     | TOLERANCE | SMF/SOD-123FL |
|--------------------------|----------------------------|-----------|---------------|
| Carrier width            | A                          | 0.1       | 2.10          |
| Carrier Length           | B                          | 0.1       | 4.00          |
| Carrier Depth            | C                          | 0.1       | 1.60          |
| Sprocket hole            | d                          | 0.05      | 1.55          |
| 7" Reel outside diameter | D                          | 2.0       | 178.00        |
| 7" Reel inner diameter   | D1                         | Min.      | 50.00         |
| Feed hole diameter       | D2                         | 0.5       | 13.00         |
| Sprocket hole position   | E                          | 0.1       | 1.75          |
| Punch hole position      | F                          | 0.1       | 3.50          |
| Punch hole pitch         | P                          | 0.1       | 4.00          |
| Sprocket hole pitch      | P0                         | 0.1       | 4.00          |
| Embossment center        | P1                         | 0.1       | 2.00          |
| Overall tape thickness   | T                          | 0.1       | 0.25          |
| Tape width               | W                          | 0.3       | 8.15          |
| Reel width               | W1                         | 1.0       | 10.50         |
| Package                  | 3000pcs/Reel, 2 Reels/ Box |           |               |
| G.W/Box                  | 1 LB                       |           |               |

## SMD TRANSIENT VOLTAGE SUPPRESSORS DIODES SMF SERIES

### IMPORTANT NOTES AND DISCLAIMER

1. RoHS Compliance: The levels of RoHS restricted materials in this product are below the maximum concentration values (also referred to as the threshold limits) permitted for such substances, or are used in an exempted application, in accordance with EU RoHS Directive (EU) 2015/863 EC (RoHS3). RoHS Test Report for this product can be obtained at Download Center.
2. REACH Compliance: REACH substances of high concern (SVHCs) information is available for this product. Since the European Chemical Agency (ECHA) has published notice of their intent to frequently revise the SVHC listing for the foreseeable future, REACH Test Report for this product can be obtained at Download Center.
3. All Product parametric performance is indicated in the Electrical Characteristics for the listed herein test conditions, unless otherwise noted. Product performance may not be indicated by the Electrical Characteristics if operated under different conditions.
4. NextGen Component, Inc (*NextGen*) reserves the right to make changes to this document and its products and specifications at any time without notice. Customers should obtain and confirm the latest product information and specifications before final design, purchase or use.
5. *NextGen* makes no warranty, representation or guarantee regarding the suitability of its products for any particular purpose, not does NextGen assume any liability for application assistance or customer product design.
6. *NextGen* does not warrant or accept any liability with products which are purchased or used for any unintended or unauthorized application. No license is granted by implication or otherwise under any intellectual property rights of *NextGen*.
7. *NextGen* products are not authorized for use as critical components in life support devices or systems without express written approval by *NextGen*.
8. *NextGen* requires that customers first obtain an RMA (Returned Merchandise Authorization) number prior to returning any products. Returns must be made within 30 days of the date of invoice, be in the original packaging, unused and like-new condition. At the time of quoting or purchasing, a product may say that it is Non-Cancelable/ Non-Returnable (NCNR). These products are not returnable and not refundable.