



**SPECIFICATION SHEET**

<b>SPECIFICATION SHEET NO.</b>	R0510- ES3EF00000S300	
<b>DATE</b>	May 10, 2024	
<b>REVISION</b>	A0	Updated With Most Recent Data - Official First Release
<b>DESCRIPTION AND MAIN PARAMETRICS</b>	<p>SMD Super Fast Recovery Rectifier, 2 Pads, Case SMAF, ES3 Series, Repetitive Peak Reverse Voltage 300V Max.</p> <p>Average Forward Rectified Current 3.0A Max.</p> <p>Operating Temp. Range -50°C ~+150°C</p> <p>Package in Tape/Reel, 3000pcs/Reel</p> <p>RoHS III/REACH Compliant and Halogen Free (HF)</p>	
<b>CUSTOMER</b>		
<b>CUSTOMER PART NO.</b>		
<b>CROSS REF. PART NO.</b>		
<b>ORIGINAL MFG/PART NO.</b>	MDD Diodes/ES3EF	
<b>PART CODE</b>	ES3EF00000S300	

<b>VENDOR APPROVE</b>		
Issued/Checked/Approved		
		
DATE: May 10, 2024		

<b>CUSTOMER APPROVE</b>	
DATE:	

## SMD SUPER FAST RECOVERY RECTIFIER ES3 SERIES CASE SMAF

### MAIN FEATURE

- The Plastic Package Carries Underwriters Laboratory Flammability Classification 94V-0
- Low Reverse Leakage
- Glass Passivated Chip Junction
- Built-in Strain Relief, Ideal For Automated Placement
- High Forward Surge Current Capability
- High Temperature Soldering Guaranteed: 250°C/10 Seconds At Terminals
- Surface Mount Package Ideally Suited for Automatic Insertion
- REACH/RoHS III Complaint and Halogen Free
- Cross Main Competitor Parts in Market



### APPLICATION

- For SMD application

### ELECTRICAL CHARACTERISTICS

- See Page 5~ Page 6 For Different Part Code

**SMD SUPER FAST RECOVERY RECTIFIER ES3 SERIES CASE SMAF**

**HOW TO ORDER**

- Please follow up Part Code Guide and indicate pat code when you order or RFQ For Custom Specification .

**PART CODE GUIDE**

**RFQ**  
Request For Quotation

CODE	NAME	KEY SPECIFICATION OPTION
ES3	Product Series Code	Super Fast Recovery Rectifier, Forward Current 3.0A
E	Repetitive Peak Reverse Voltage Code	A: 50V Max. ; B: 100V Max. ; C: 150V Max.; D: 200V Max.; E: 300V Max.; G: 400V Max.; J: 600V Max
F0	Case Code	A0: Case DO-214AC/SMA; B0: Case DO-214AA/SMB; BF: Case SMBF; C0: Case SMC/DO-214AB ; F0: Case SMAF ; W0: Case SMF/SOD-123FL
0000S	Internal Control Code	Custom letter A~Z, a-z or Digits (0-9)
300	DC Blocking Voltage Code	050: 50V Max.; 100: 100V Max.; 150: 150V Max.; 200: 200V Max. 300: 300V Max.; 400: 400V Max.; 600: 600V Max.

**SMD SUPER FAST RECOVERY RECTIFIER ES3 SERIES CASE SMAF**

**DIMENSION** (Unit: Inch/mm)

Image for reference



**Marking:**

See Page -6 Marking List  
For different Part code

**SMAF**

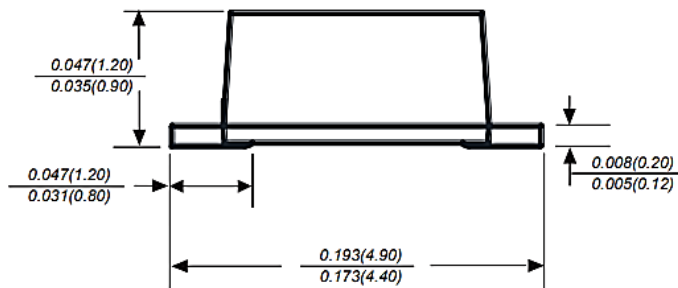
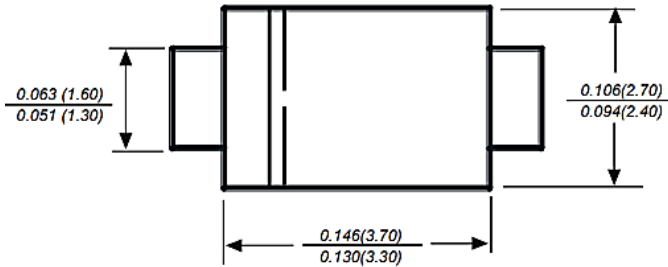

**Recommend Pad Layout**

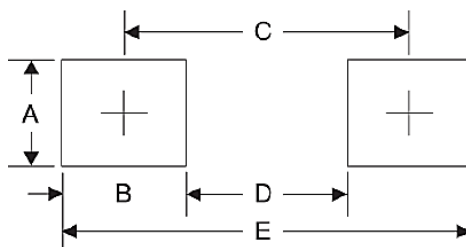

Symbol	Unit (Inch)	Unit (mm)
A	0.071	1.80
B	0.063	1.60
C	0.150	3.80
D	0.087	2.20
E	0.213	5.40

**SMD SUPER FAST RECOVERY RECTIFIER ES3 SERIES CASE SMAF**
**MECHANICAL DATA**

CASE	TERMINALS	POLARITY	MOUNTING POSITION	WEIGHT PER PIECE
JEDEC SMAF Molded Plastic Body	Solder plated, Solderable per MIL-STD-750, Method 2026	Polarity Symbol Marking On Case	Any	0.0018 Ounce, 0.064 Grams

**MAXIMUM RATINGS AND ELECTRICAL CHARACTERISTICS**

Ratings at 25 °C ambient temperature unless otherwise specified. Single phase half-wave 60Hz, resistive or inductive load, for capacitive load current derate by 20%.

PARAMETER		SYMBOLS	VALUE	UNITS
Maximum Average Forward Rectified Current		$I_{AV}$	3.0	A
Peak Forward Surge Current 8.3ms Single Half Sine-wave Superimposed On Rated Load (JEDEC Method)		$I_{FSM}$	50	A
Maximum DC Reverse Current At Rated DC Blocking Voltage	$T_A=25^{\circ}C$	$I_R$	5	$\mu A$
	$T_A=125^{\circ}C$		200	
Maximum Reverse Recovery Time (NOTE 1)		$t_{rr}$	35	ns
Typical Junction Capacitance (NOTE 2)		$C_J$	60	pF
Typical Thermal Resistance (NOTE 3)		$R_{\theta JA}$	40	$^{\circ}C/W$
Operating Junction And Storage Temperature Range		$T_J, T_{STG}$	-50 to +150	$^{\circ}C$

Note:

- Reverse Recovery Condition  $I_F=0.5A, I_R=1.0A, I_{rr}=0.25A$
- Measured at 1MHz and Applied Reverse Voltage of 4.0V D.C.
- PCB Mounted On 0.20"x0.20" (5.08 x 5.08mm) Copper Pad Area.

**SMD SUPER FAST RECOVERY RECTIFIER ES3 SERIES CASE SMAF**
**MAXIMUM RATINGS AND ELECTRICAL CHARACTERISTICS FOR DIFFERENT PART CODE**

Ratings at 25 °C ambient temperature unless otherwise specified. Single phase half-wave 60Hz, resistive or inductive load, for capacitive load current derate by 20%.

PART CODE	Max. Repetitive Peak Reverse Voltage	Max. RMS Voltage	Max. DC Blocking Voltage	Max. Instantaneous Forward Voltage @3A	Marking List
	V <sub>RRM</sub>	V <sub>RMS</sub>	V <sub>DC</sub>	V <sub>F</sub>	
	V				
ES3AF00000S050	50	35	50	0.95	ES3AF
ES3BF00000S100	100	70	100	0.95	ES3BF
ES3CF00000S150	150	105	150	0.95	ES3CF
ES3DF00000S200	200	140	200	0.95	ES3DF
<b>ES3EF00000S300</b>	<b>300</b>	<b>210</b>	<b>300</b>	<b>1.25</b>	<b>ES3EF</b>
ES3GF00000S400	400	280	400	1.25	ES3GF
ES3JF00000S600	600	420	600	1.70	ES3JF

**SMD SUPER FAST RECOVERY RECTIFIER ES3 SERIES CASE SMAF**

**RATINGS AND CHARACTERISTIC CURVES** (For Reference Only)

Figure 1. Reverse Recovery Time Characteristic And Test Circuit Diagram

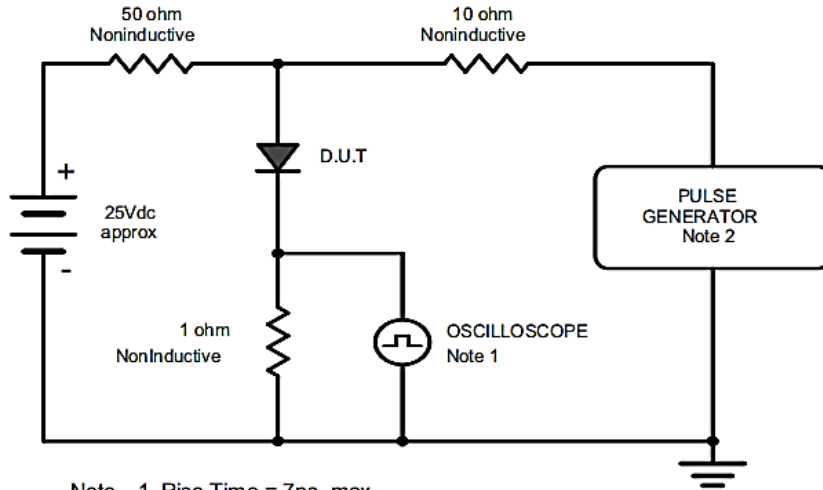

- Note: 1. Rise Time = 7ns, max.  
Input Impedance = 1megohm, 22pF.  
2. Rise Time = 10ns, max.  
Source Impedance = 50 ohms.

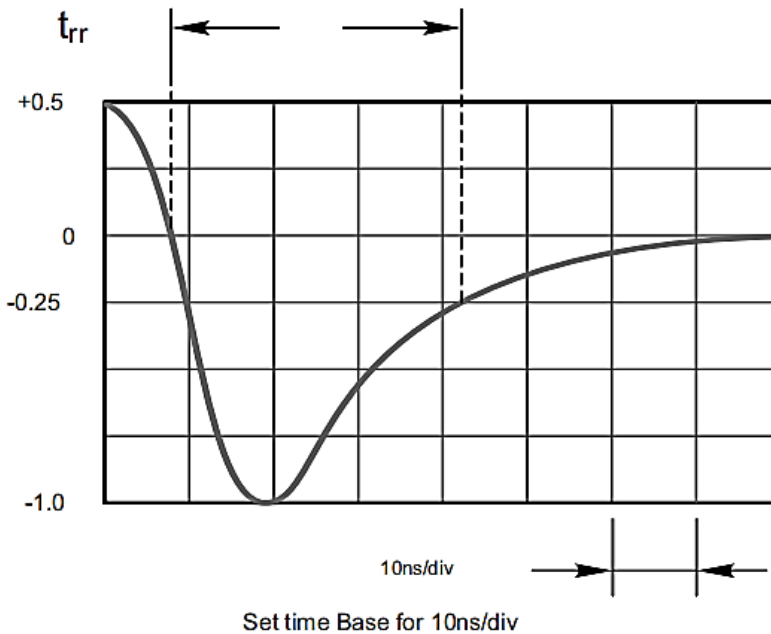

**SMD SUPER FAST RECOVERY RECTIFIER ES3 SERIES CASE SMAF**

**RATINGS AND CHARACTERISTIC CURVES** (For Reference Only)

Figure 2. Maximum Average Forward Current Rating

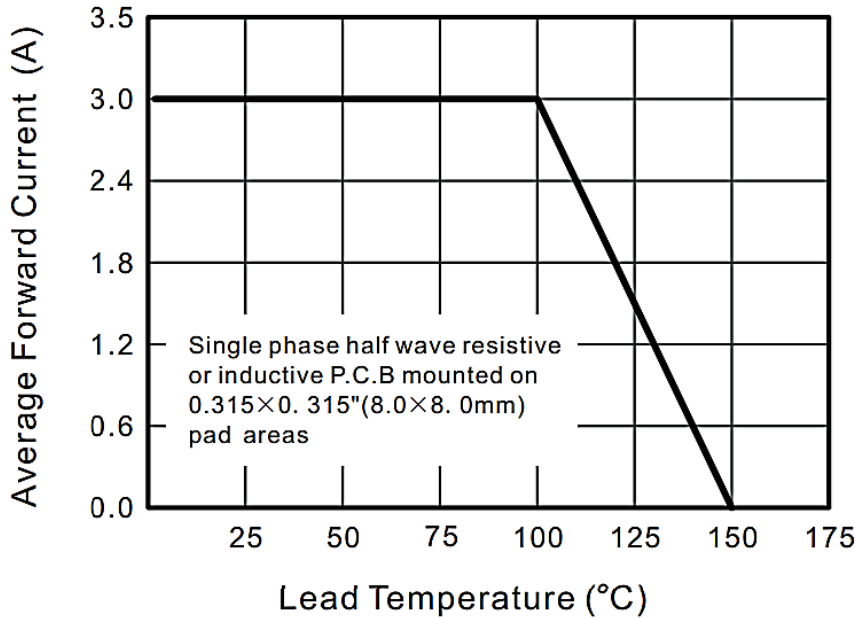
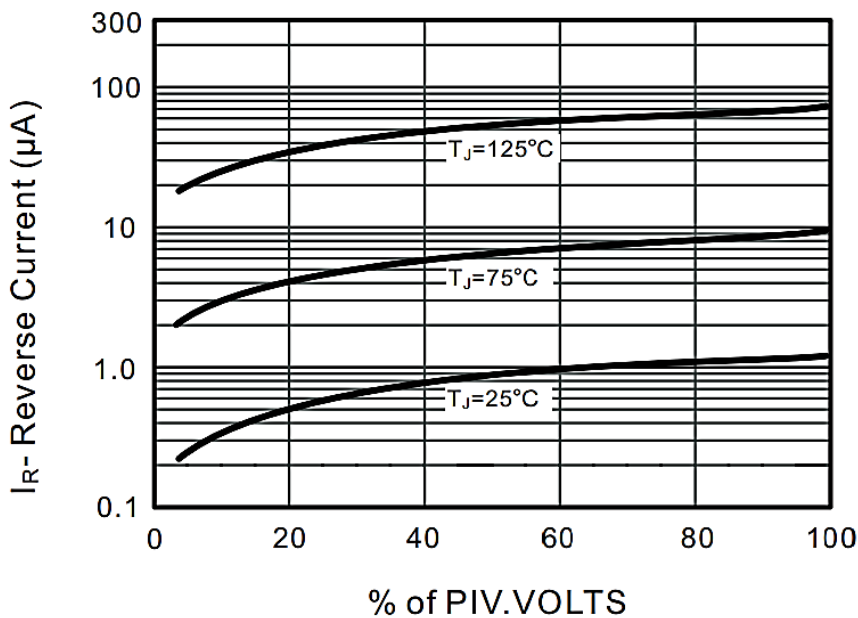

Figure 3. . Typical Reverse Characteristics





**SMD SUPER FAST RECOVERY RECTIFIER ES3 SERIES CASE SMAF**

**RATINGS AND CHARACTERISTIC CURVES** (For Reference Only)

Figure 4. Typical Forward Characteristics

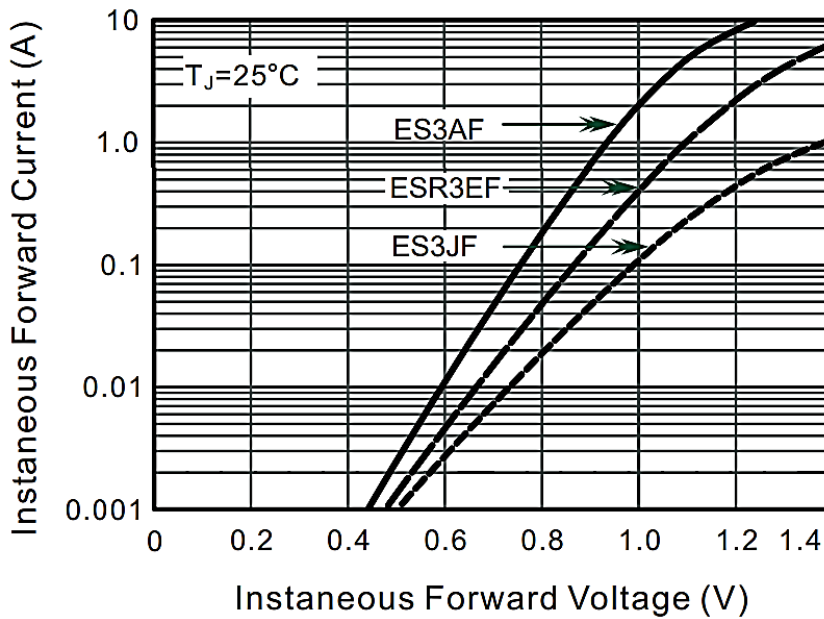
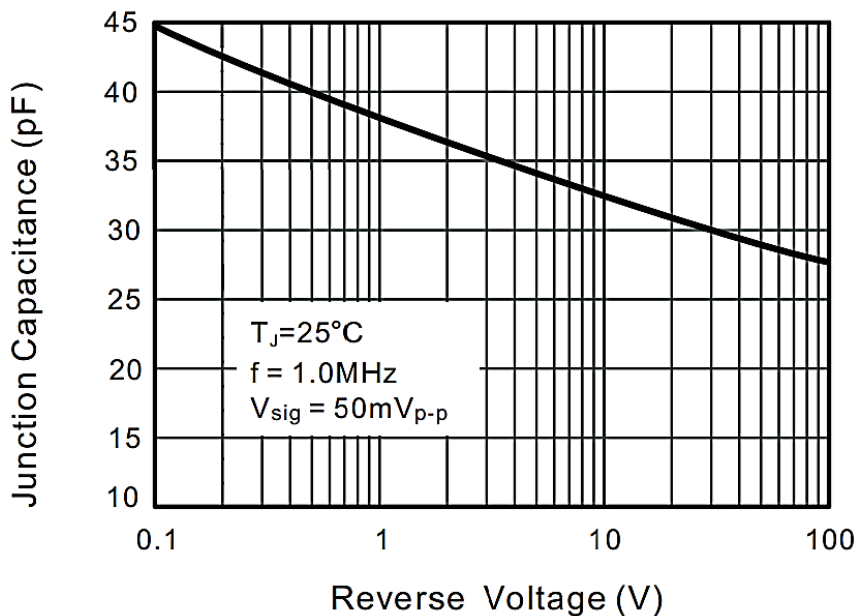
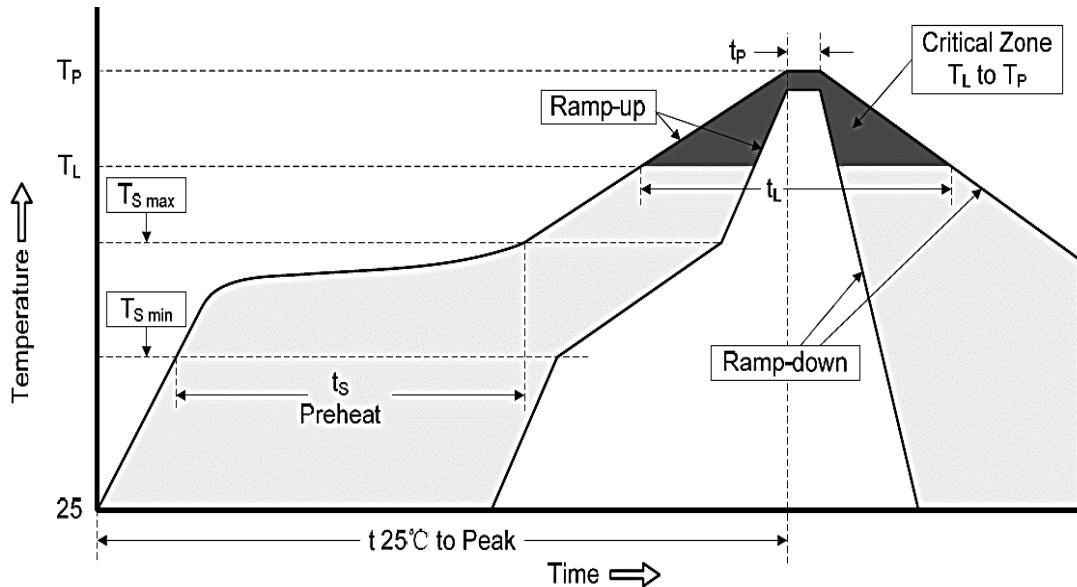

Figure 5. Typical Junction Capacitance



**SMD SUPER FAST RECOVERY RECTIFIER ES3 SERIES CASE SMAF**
**RELIABILITY**

NUMBER	EXPERIMENT ITEMS	EXPERIMENT METHOD AND CONDITIONS	REFERENCE DOCUMENTS
1	Solder Resistance Test	Test 260°C± 5°C for 10 ± 2 sec. Immerse body into solder 1/16" ± 1/32"	MIL-STD-750D METHOD-2031.2
2	Solderability Test	230°C ±5°C for 5 sec.	MIL-STD-750D METHOD-2026.1 0
3	Pull Test	1 kg in axial lead direction for 10 sec.	MIL-STD-750D METHOD-2036.4
4	Bend Test	0.5Kg Weight Applied To Each Lead, Bending Arcs 90 °C ± 5 °C For 3 Times	MIL-STD-750D METHOD-2036.4
5	High Temperature Reverse Bias Test	TA=100°C for 1000 Hours at VR=80% Rated VR	MIL-STD-750D METHOD-1038.4
6	Forward Operation Life Test	TA=25°C Rated Average Rectified Current	MIL-STD-750D METHOD-1027.3
7	Intermittent Operation Life Test	On state: 5 min with rated IRMS Power Off state: 5 min with Cool Forced Air. On and off for 1000 cycles.	MIL-STD-750D METHOD-1036.3
8	Pressure Cooker Test	15 PSIG, TA=121°C, 4 hours	MIL-S-19500 APPENOIXC
9	Temperature Cycling Test	-55°C~+125°C; 30 Minutes For Dwelled Time 5 minutes for transferred time. Total: 10 cycles.	MIL-STD-750D METHOD-1051.7
10	Thermal Shock Test	0°C for 5 minutes., 100°C for 5minutes, Total: 10 cycles	MIL-STD-750D METHOD-1056.7
11	Forward Surge Test	8.3ms Single Sale Sine-wave One Surge.	MIL-STD-750D METHOD-4066.4
12	Humidity Test	TA=65°C, RH=98% for 1000 hours.	MIL-STD-750D METHOD-1021.3
13	High Temperature Storage life Test	150°C for 1000 Hours	MIL-STD-750D METHOD-1031.5

**SMD SUPER FAST RECOVERY RECTIFIER ES3 SERIES CASE SMAF**
**SUGGESTED REFLOW PROFILE - For Reference Only**

PROFILE FEATURE		PB-FREE ASSEMBLY
Average Ramp-up Rate (Ts Max to Tp)		3°C/second Max
Preheat	Temperature Min (Ts Min.)	150°C
	Temperature Max (Ts Max.)	200°C
	Time (ts Min. to ts Max.)	60 ~ 180 seconds
Time maintained above	Temperature (Tl)	217°C
	Time (tl)	60 ~ 150 seconds
Peak/Classification Temperature (Tp)		260 °C
Time within 5°C of actual Peak Temperature (tp)		20 ~ 40 seconds
Ramp-down rate		6 °C /Second Max.
Time 25 °C to Peak Temperature		8 minutes Max.
Suggest reflow times		3 Times Max.

**SMD SUPER FAST RECOVERY RECTIFIER ES3 SERIES CASE SMAF**
**TAPE/REEL (Unit: mm)**

All Devices are packed in accordance with EIA standard RS-481-A and specifications.



ITEM	SYMBOL	TOLERANCE	SMAF
Carrier width	A	0.1	2.80
Carrier Length	B	0.1	4.75
Carrier Depth	C	0.1	1.42
Sprocket hole	d	0.05	1.50
7" Reel outside diameter	D	2.0	178.0
7" Reel inner diameter	D1	Min.	54.40
Feed hole diameter	D2	0.5	13.00
Sprocket hole position	E	0.1	1.75
Punch hole position	F	0.1	5.05
Punch hole pitch	P	0.1	4.00
Sprocket hole pitch	P0	0.1	4.00
Embossment center	P1	0.1	2.00
Overall tape thickness	T	0.1	0.30
Tape width	W	0.3	8.00
Reel width	W1	1.0	12.30
MPQ/Reel	3000pcs/Reel		

## SMD SUPER FAST RECOVERY RECTIFIER ES3 SERIES CASE SMAF

### IMPORTANT NOTES AND DISCLAIMER

1. **ROHS COMPLIANCE:** The levels of RoHS restricted materials in this product are below the maximum concentration values (also referred to as the threshold limits) permitted for such substances, or are used in an exempted application, in accordance with EU RoHS Directive (EU) 2015/863 EC (RoHS3). RoHS Test Report for this product can be obtained at Download Center.
2. **REACH COMPLIANCE:** REACH substances of high concern (SVHCs) information is available for this product. Since the European Chemical Agency (ECHA) has published notice of their intent to frequently revise the SVHC listing for the foreseeable future, REACH Test Report for this product can be obtained at Download Center.
3. All Product parametric performance is indicated in the Electrical Characteristics for the listed herein test conditions, unless otherwise noted. Product performance may not be indicated by the Electrical Characteristics if operated under different conditions.
4. NextGen Component, Inc (*NextGen*) reserves the right to make changes to this document and its products and specifications at any time without notice. Customers should obtain and confirm the latest product information and specifications before final design, purchase or use.
5. *NextGen* makes no warranty, representation or guarantee regarding the suitability of its products for any particular purpose, not does *NextGen* assume any liability for application assistance or customer product design.
6. *NextGen* does not warrant or accept any liability with products which are purchased or used for any unintended or unauthorized application. No license is granted by implication or otherwise under any intellectual property rights of NextGen.
7. *NextGen* products are not authorized for use as critical components in life support devices or systems without express written approval by *NextGen*.
8. *NextGen* requires that customers first obtain an RMA (Returned Merchandise Authorization) number prior to returning any products. Returns must be made within 30 days of the date of invoice, be in the original packaging, unused and like-new condition. At the time of quoting or purchasing, a product may say that it is Non-Cancelable/ Non-Returnable (NCNR). These products are not returnable and not refundable.