



SPECIFICATION SHEET

SPECIFICATION SHEET NO.	R0512- SS58B00000S080	
DATE	May 12, 2024	
REVISION	A1	Updated With Most Recent Data
DESCRIPTION AND MAIN PARAMETRICS	<p>SMD Schottky Barrier Rectifier 2 Pads, Case DO-214AA/SMB SS5 Series, Repetitive Peak Reverse Voltage 80V Max. Average Forward Rectified Current 5.0A Max. Operating Junction Temp. Range -50°C ~+150°C Package in Tape/Reel, 3000pcs/Reel RoHS III/REACH Compliant and Halogen Free (HF)</p>	
CUSTOMER		
CUSTOMER PART NO.		
CROSS REF. PART NO.		
ORIGINAL MFG/PART NO.	MDD Diodes/SS58B	
PART CODE	SS58B00000S080	

VENDOR APPROVE		
Issued/Checked/Approved		
		
DATE: May 12, 2024		

CUSTOMER APPROVE	
DATE:	

SMD SCHOTTKY BARRIER RECTIFIER SS5 SERIES CASE SMB

MAIN FEATURE

- The Plastic Package Carries Underwriters Laboratory Flammability Classification 94V-0
- Low Power Loss and High Efficiency
- Metal Silicon Junction and Majority Carrier Conduction
- Built-in Strain Relief and Ideal For Automated Placement
- High Forward Surge Current Capability
- High Temperature Soldering Guaranteed: 250°C/10 Seconds At Terminals
- Surface Mount Package Ideally Suited for Automatic Insertion
- REACH/RoHS III Complaint and Halogen Free
- Cross Main Competitor Parts in Market



APPLICATION

- For SMD application

ELECTRICAL CHARACTERISTICS

- See Page 5~ Page 6 For Different Part Code

SMD SCHOTTKY BARRIER RECTIFIER SS5 SERIES CASE SMB

HOW TO ORDER

- Please Follow Up Part Code Guide And Indicate Pat Code When You Order Or RFQ For Custom Specification .

PART CODE GUIDE

RFQ
Request For Quotation

CODE	NAME	KEY SPECIFICATION OPTION
SS5	Product Series Code	SMD Schottky Barrier Rectifier, Forward Current 5.0A
8	Repetitive Peak Reverse Voltage Code	2: 20V Max. ; 3: 30V Max. ; 4: 40V Max.; 5: 50V Max.; 6: 60V Max.; 8: 80V Max.; 10: 100V Max.; 150: 150V Max.; 200: 200V Max
B0	Case Code	A0: Case DO-214AC/SMA; B0: Case DO-214AA/SMB; BF: Case SMBF; C0: Case SMC/DO-214AB ; F0: Case SMAF; W0: Case SMF/SOD-123FL
0000S	Internal Control Code	Custom letter A~Z, a-z or Digits (0-9)
080	DC Blocking Voltage Code	020: 20V Max. ; 030: 30V Max. ; 040: 40V Max.; 050: 50V Max.; 060: 60V Max.; 080: 80V Max.; 100: 100V Max.; 150: 150V Max.; 200: 200V Max

SMD SCHOTTKY BARRIER RECTIFIER SS5 SERIES CASE SMB

DIMENSION (Unit: Inch/mm)

Image for reference



Marking:

See Page -6 Marking List

For different Part code

SMB/DO-214AA

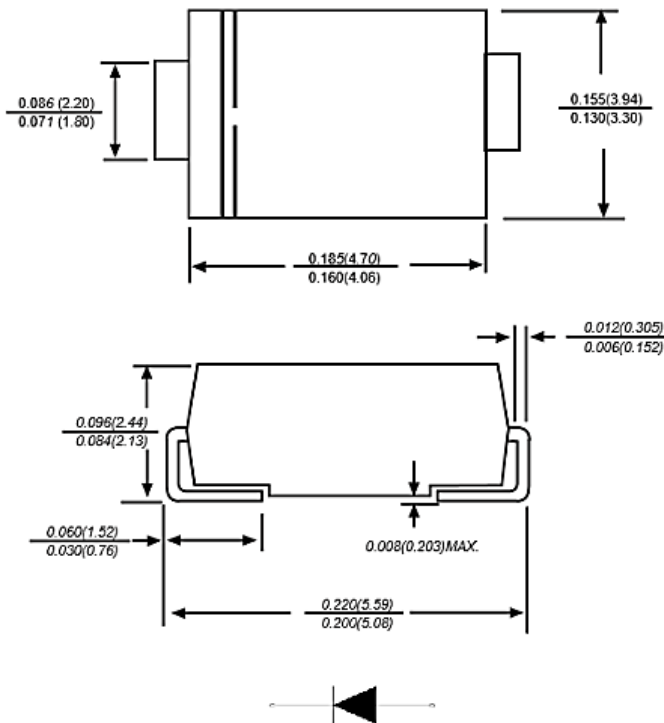

Recommend Pad Layout

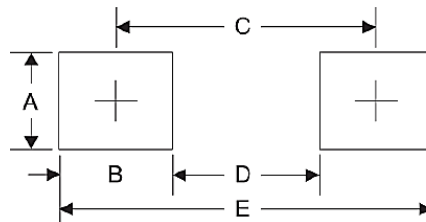

Symbol	Unit (inch)	Unit (mm)
A	0.110	2.80
B	0.094	2.40
C	0.181	4.60
D	0.086	2.20
E	0.276	7.00

SMD SCHOTTKY BARRIER RECTIFIER SS5 SERIES CASE SMB
MECHANICAL DATA

CASE	TERMINALS	POLARITY	MOUNTING POSITION	WEIGHT PER PIECE
JEDEC DO-214AA/SMB Molded Plastic Body	Solder plated, Solderable per MIL-STD-750, Method 2026	Polarity Symbol Marking On Case	Any	0.0030 Ounce, 0.0950 Grams

MAXIMUM RATINGS AND ELECTRICAL CHARACTERISTICS

Ratings at 25 °C ambient temperature unless otherwise specified. Single phase half-wave 60Hz, resistive or inductive load, for capacitive load current derate by 20%.

PARAMETER	SYMBOLS	VALUE	UNITS
Maximum Average Forward Rectified Current	I _{AV}	5.0	A
Peak Forward Surge Current 8.3ms Single Half Sine-wave Superimposed On Rated Load (JEDEC Method)	I _{FSM}	150	A
Typical Thermal Resistance (Note 2)	R _{θJA}	50	°C/W
Operating Junction Temperature Range	T _J	-50 to +150	°C
Storage Temperature Range	T _{STG}	-50 to +150	°C

Note:

1. Measured at 1MHz And Applied Reverse Voltage Of 4.0V D.C
2. P.C.B. Mounted With 0.2"x0.2"(5.08 x 5.08 mm) Copper Pad Areas

SMD SCHOTTKY BARRIER RECTIFIER SS5 SERIES CASE SMB
MAXIMUM RATINGS AND ELECTRICAL CHARACTERISTICS FOR DIFFERENT PART CODE

Ratings At 25 °C Ambient Temperature Unless Otherwise Specified. Single Phase Half-wave 60hz, resistive Or Inductive Load, For Capacitive Load Current Derate By 20%.

PART CODE	Max. Repetitive Peak Reverse Voltage	Max. RMS Voltage	Max. DC Blocking Voltage	Max. Inst. Forward Voltage @ 5.0A	Maximum DC Reverse Current At Rated DC Blocking Voltage		Typical Junction Cap. (Note 1)	Marking List
					@ 25 °C	@ 125 °C		
					V _{RRM}	V _{RMS}		
V	V	V	V	mA	pF			
SS52B00000S020	20	14	20	0.55	1.0	50	500	SS52B
SS53B00000S030	30	21	30	0.55	1.0	50	500	SS53B
SS54B00000S040	40	28	40	0.55	1.0	50	500	SS54B
SS55B00000S050	50	35	50	0.70	0.3	25	300	SS55B
SS56B00000S060	60	42	60	0.70	0.3	25	300	SS56B
SS58B00000S080	80	56	80	0.85	0.3	25	300	SS58B
SS510B0000S100	100	70	100	0.85	0.3	25	300	SS510B
SS5150B000S150	150	105	150	0.85	0.3	25	300	SS5150B
SS5200B000S200	200	140	200	0.85	0.3	25	300	SS5200B or SS520B

Note:

1. Measured at 1MHz And Applied Reverse Voltage Of 4.0V D.C
2. P.C.B. mounted with 0.20"x0.20" (5.08 x 5.08 mm) Copper Pad Areas

5/12/2024

SMD SCHOTTKY BARRIER RECTIFIER SS5 SERIES CASE SMB

RATINGS AND CHARACTERISTIC CURVES (For Reference Only)

Fig.1 Forward Current Derating Curve

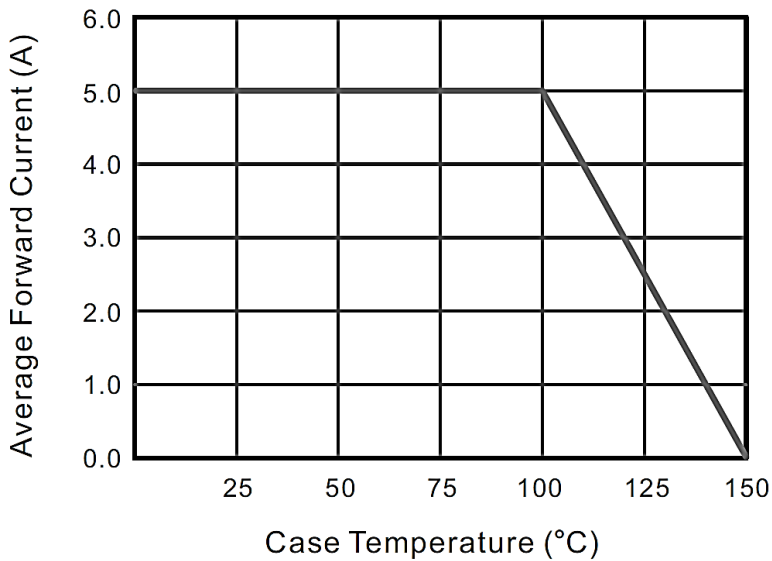
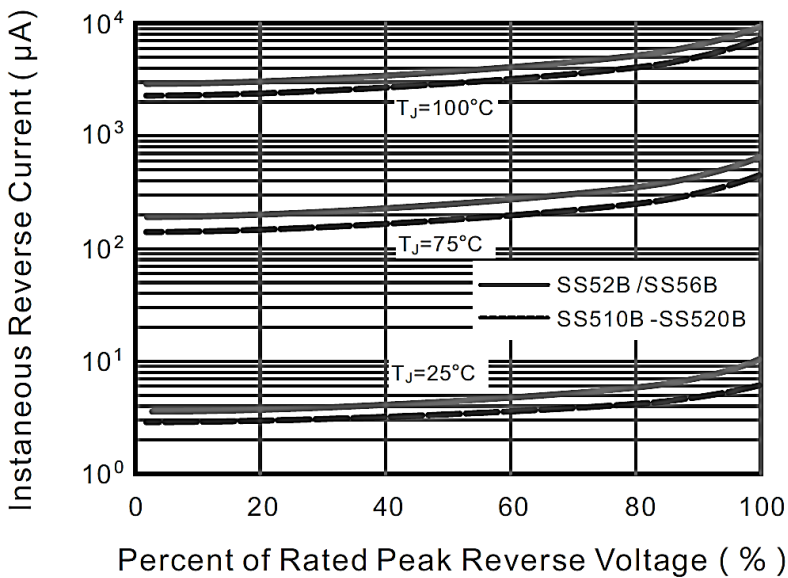

Fig.2 Typical Reverse Characteristics



SMD SCHOTTKY BARRIER RECTIFIER SS5 SERIES CASE SMB

RATINGS AND CHARACTERISTIC CURVES (For Reference Only)

Fig.3 Typical Forward Characteristic

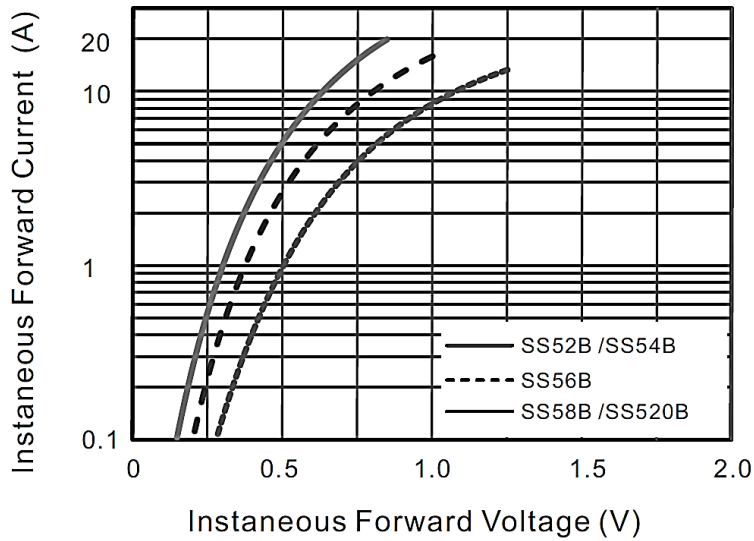
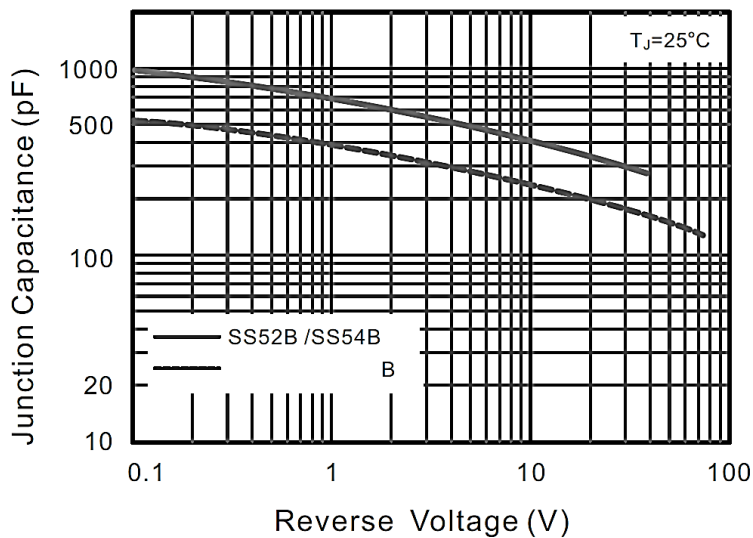

Fig.4 Typical Junction Capacitance



SMD SCHOTTKY BARRIER RECTIFIER SS5 SERIES CASE SMB

RATINGS AND CHARACTERISTIC CURVES (For Reference Only)

Fig.5 Maximum Non-Repetitive Peak Forward Surge Current

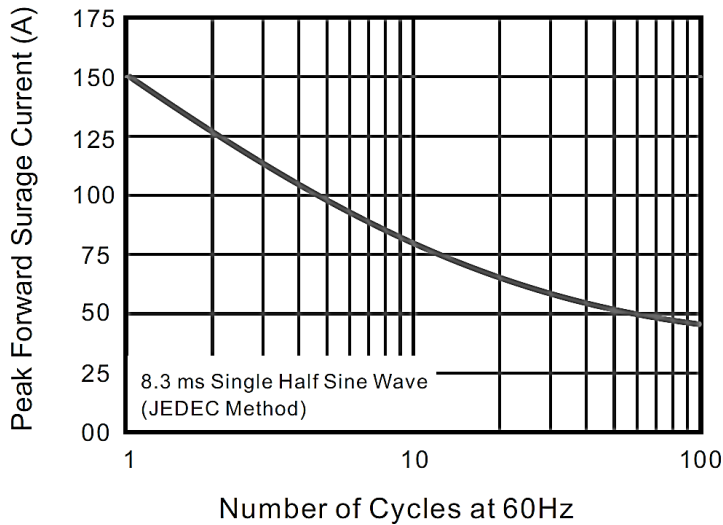
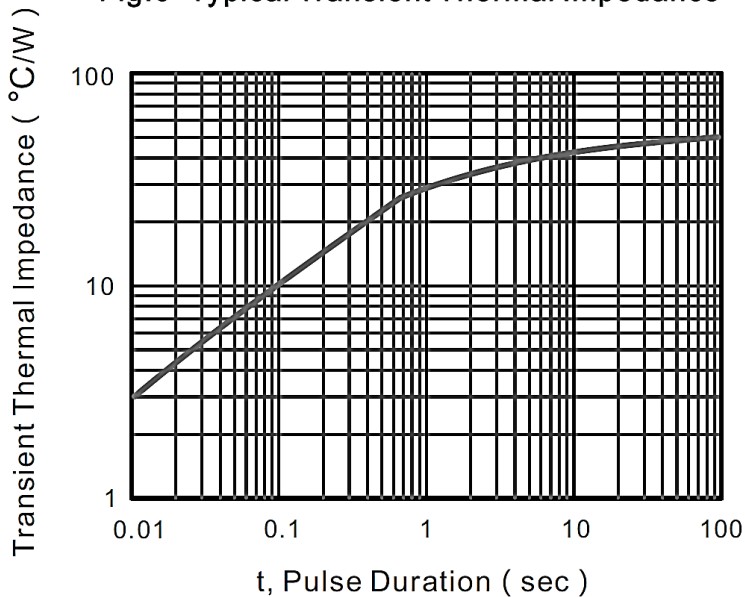

Fig.6- Typical Transient Thermal Impedance



SMD SCHOTTKY BARRIER RECTIFIER SS5 SERIES CASE SMB
RELIABILITY

NUMBER	EXPERIMENT ITEMS	EXPERIMENT METHOD AND CONDITIONS	REFERENCE DOCUMENTS
1	Solder Resistance Test	Test 260°C± 5°C for 10 ± 2 sec. Immerse body into solder 1/16" ± 1/32"	MIL-STD-750D METHOD-2031.2
2	Solderability Test	230°C ±5°C for 5 sec.	MIL-STD-750D METHOD-2026.1 0
3	Pull Test	1 kg in axial lead direction for 10 sec.	MIL-STD-750D METHOD-2036.4
4	Bend Test	0.5Kg Weight Applied To Each Lead, Bending Arcs 90 °C ± 5 °C For 3 Times	MIL-STD-750D METHOD-2036.4
5	High Temperature Reverse Bias Test	TA=100°C for 1000 Hours at VR=80% Rated VR	MIL-STD-750D METHOD-1038.4
6	Forward Operation Life Test	TA=25°C Rated Average Rectified Current	MIL-STD-750D METHOD-1027.3
7	Intermittent Operation Life Test	On state: 5 min with rated IRMS Power Off state: 5 min with Cool Forced Air. On and off for 1000 cycles.	MIL-STD-750D METHOD-1036.3
8	Pressure Cooker Test	15 PSIG, TA=121°C, 4 hours	MIL-S-19500 APPENOIXC
9	Temperature Cycling Test	-55°C~+125°C; 30 Minutes For Dwelled Time 5 minutes for transferred time. Total: 10 cycles.	MIL-STD-750D METHOD-1051.7
10	Thermal Shock Test	0°C for 5 minutes., 100°C for 5minutes, Total: 10 cycles	MIL-STD-750D METHOD-1056.7
11	Forward Surge Test	8.3ms Single Sale Sine-wave One Surge.	MIL-STD-750D METHOD-4066.4
12	Humidity Test	TA=65°C, RH=98% for 1000 hours.	MIL-STD-750D METHOD-1021.3
13	High Temperature Storage life Test	150°C for 1000 Hours	MIL-STD-750D METHOD-1031.5

SMD SCHOTTKY BARRIER RECTIFIER SS5 SERIES CASE SMB
SUGGESTED REFLOW PROFILE - For Reference Only

PROFILE FEATURE		PB-FREE ASSEMBLY
Average Ramp-up Rate (Ts Max to Tp)		3°C/second Max
Preheat	Temperature Min (Ts Min.)	150°C
	Temperature Max (Ts Max.)	200°C
	Time (ts Min. to ts Max.)	60 ~ 180 seconds
Time maintained above	Temperature (Tl)	217°C
	Time (tl)	60 ~ 150 seconds
Peak/Classification Temperature (Tp)		260 °C
Time within 5°C of actual Peak Temperature (tp)		20 ~ 40 seconds
Ramp-down rate		6 °C /Second Max.
Time 25 °C to Peak Temperature		8 minutes Max.
Suggest reflow times		3 Times Max.

SMD SCHOTTKY BARRIER RECTIFIER SS5 SERIES CASE SMB
TAPE/REEL (Unit: mm)

All Devices are packed in accordance with EIA standard RS-481-A and specifications.



ITEM	SYMBOL	TOLERANCE	SMB/DO-214AA
Carrier width	A	0.1	3.81
Carrier Length	B	0.1	5.41
Carrier Depth	C	0.1	2.42
Sprocket hole	d	0.05	1.50
13" Reel outside diameter	D	2.0	330.00
13" Reel inner diameter	D1	Min.	50.00
Feed hole diameter	D2	0.5	13.00
Sprocket hole position	E	0.1	1.75
Punch hole position	F	0.1	5.55
Punch hole pitch	P	0.1	8.00
Sprocket hole pitch	P0	0.1	4.00
Embossment center	P1	0.1	2.00
Overall tape thickness	T	0.1	0.30
Tape width	W	0.3	12.00
Reel width	W1	1.0	12.30
MPQ/Reel	3000pcs/Reel		

SMD SCHOTTKY BARRIER RECTIFIER SS5 SERIES CASE SMB

IMPORTANT NOTES AND DISCLAIMER

1. **ROHS COMPLIANCE:** The levels of RoHS restricted materials in this product are below the maximum concentration values (also referred to as the threshold limits) permitted for such substances, or are used in an exempted application, in accordance with EU RoHS Directive (EU) 2015/863 EC (RoHS3). RoHS Test Report for this product can be obtained at Download Center.
2. **REACH COMPLIANCE:** REACH substances of high concern (SVHCs) information is available for this product. Since the European Chemical Agency (ECHA) has published notice of their intent to frequently revise the SVHC listing for the foreseeable future, REACH Test Report for this product can be obtained at Download Center.
3. All Product parametric performance is indicated in the Electrical Characteristics for the listed herein test conditions, unless otherwise noted. Product performance may not be indicated by the Electrical Characteristics if operated under different conditions.
4. NextGen Component, Inc (*NextGen*) reserves the right to make changes to this document and its products and specifications at any time without notice. Customers should obtain and confirm the latest product information and specifications before final design, purchase or use.
5. *NextGen* makes no warranty, representation or guarantee regarding the suitability of its products for any particular purpose, not does *NextGen* assume any liability for application assistance or customer product design.
6. *NextGen* does not warrant or accept any liability with products which are purchased or used for any unintended or unauthorized application. No license is granted by implication or otherwise under any intellectual property rights of NextGen.
7. *NextGen* products are not authorized for use as critical components in life support devices or systems without express written approval by *NextGen*.
8. *NextGen* requires that customers first obtain an RMA (Returned Merchandise Authorization) number prior to returning any products. Returns must be made within 30 days of the date of invoice, be in the original packaging, unused and like-new condition. At the time of quoting or purchasing, a product may say that it is Non-Cancelable/ Non-Returnable (NCNR). These products are not returnable and not refundable.