




**SPECIFICATION SHEET**

|   |  |   |
|---|--|---|
| <b>SPECIFICATION SHEET NO.</b>          | R0512- SS2150F000S150  |   |
| <b>DATE</b>                             | May 12, 2024   |   |
| <b>REVISION</b>                         | A0   | Updated With Most Recent Data- Official First Release |
| <b>DESCRIPTION AND MAIN PARAMETRICS</b> | <p>SMD Schottky Barrier Rectifier 2 Pads, Case SMAF</p> <p>SS2 Series, Repetitive Peak Reverse Voltage 150V Max.</p> <p>Average Forward Rectified Current 2.0A Max.</p> <p>Operating Junction Temperature Range: -55°C ~+150°C</p> <p>Package in Tape/Reel, 3000pcs/Reel</p> <p>RoHS III/REACH Compliant and Halogen Free (HF)</p> |   |
| <b>CUSTOMER</b>                         |  |   |
| <b>CUSTOMER PART NO.</b>                |  |   |
| <b>CROSS REF. PART NO.</b>              |  |   |
| <b>ORIGINAL MFG/PART NO.</b>            | MDD Diodes/SS2150F   |   |
| <b>PART CODE</b>                        | SS2150F000S150   |   |

|                         |   |   |
|-------------------------|---|---|
| <b>VENDOR APPROVE</b>   |   |   |
| Issued/Checked/Approved |  |   |
|                         |   |  |
| DATE: May 12, 2024      |   |   |

|                         |  |
|-------------------------|--|
| <b>CUSTOMER APPROVE</b> |  |
|                         |  |
| DATE:                   |  |

## SMD SCHOTTKY BARRIER RECTIFIER SS2 SERIES CASE SMAF

### MAIN FEATURE

- The Plastic Package Carries Underwriters Laboratory Flammability Classification 94V-0
- Low Power Loss and High Efficiency
- Metal Silicon Junction and Majority Carrier Conduction
- Built-in Strain Relief and Ideal For Automated Placement
- High Forward Surge Current Capability
- High Temperature Soldering Guaranteed: 250°C/10 Seconds At Terminals
- Surface Mount Package Ideally Suited for Automatic Insertion
- REACH/RoHS III Complaint and Halogen Free
- Cross Main Competitor Parts in Market



### APPLICATION

- For SMD application

### ELECTRICAL CHARACTERISTICS

- See Page 5~ Page 6 For Different Part Code

**SMD SCHOTTKY BARRIER RECTIFIER SS2 SERIES CASE SMAF**

**HOW TO ORDER**

- Please Follow Up Part Code Guide And Indicate Pat Code When You Order Or RFQ For Custom Specification .

**PART CODE GUIDE**

**RFQ**  
Request For Quotation

| CODE | NAME                                    | KEY SPECIFICATION OPTION  |
|------|---|---|
| SS2  | Product Series Code                     | SMD Schottky Barrier Rectifier, Forward Current 2.0A  |
| 150  | Repetitive Peak<br>Reverse Voltage Code | 2: 20V Max. ; 3: 30V Max. ; 4: 40V Max.; 5: 50V Max.; 6: 60V Max.;<br>8: 80V Max.; 10: 100V Max.; 150: 150V Max.; 200: 200V Max                 |
| F0   | Case Code                               | A0: Case DO-214AC/SMA; B0: Case DO-214AA/SMB; BF: Case SMBF;<br>C0: Case SMC/DO-214AB ; F0: Case SMAF; W0: Case SMF/SOD-123FL                   |
| 00S  | Internal Control Code                   | Custom letter A~Z, a-z or Digits (0-9)  |
| 150  | DC Blocking Voltage<br>Code             | 020: 20V Max. ; 030: 30V Max. ; 040: 40V Max.; 050: 50V Max.;<br>060: 60V Max.; 080: 80V Max.; 100: 100V Max.; 150: 150V Max.;<br>200: 200V Max |

**SMD SCHOTTKY BARRIER RECTIFIER SS2 SERIES CASE SMAF**

**DIMENSION** (Unit: Inch/mm)

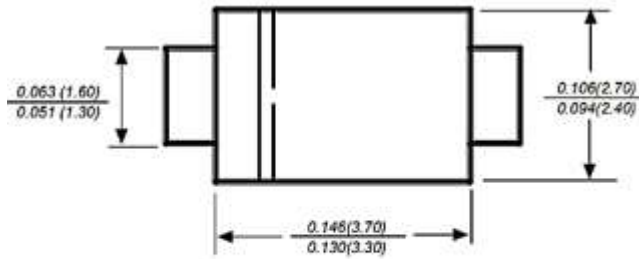
Image for reference



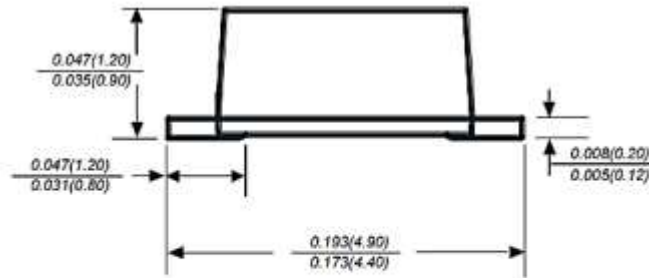
**Marking:**

See Page -6 Marking List

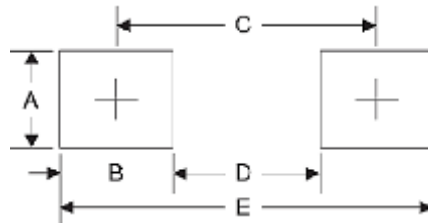
For different Part code



**SMAF**



**Recommend Pad Layout**



| Symbol | Unit (Inch) | Unit (mm) |
|--------|-------------|-----------|
| A      | 0.071       | 1.80      |
| B      | 0.063       | 1.60      |
| C      | 0.150       | 3.80      |
| D      | 0.087       | 2.20      |
| E      | 0.213       | 5.40      |

**SMD SCHOTTKY BARRIER RECTIFIER SS2 SERIES CASE SMAF**
**MECHANICAL DATA**

| CASE                                 | TERMINALS  | POLARITY                              | MOUNTING POSITION | WEIGHT PER PIECE                |
|--------------------------------------|--|---------------------------------------|-------------------|---------------------------------|
| JEDEC<br>SMAF Molded<br>Plastic Body | Solder plated, Solderable per<br>MIL-STD-750,<br>Method 2026 | Polarity Symbol<br>Marking On<br>Case | Any               | 0.00095 Ounce,<br>0.02700 Grams |

**MAXIMUM RATINGS AND ELECTRICAL CHARACTERISTICS**

Ratings At 25 °C Ambient Temperature Unless Otherwise Specified. Single Phase Half-wave 60Hz, resistive Or Inductive Load, For Capacitive Load Current Derate By 20%.

| PARAMETER  | SYMBOLS               | VALUE       | UNITS       |    |
|--|-----------------------|-------------|-------------|----|
| Maximum Average Forward Rectified Current  | $I_{AV}$              | 2.0         | A           |    |
| Peak Forward Surge Current 8.3ms Single Half Sine-wave Superimposed On Rated Load (JEDEC Method) | $I_{FSM}$             | 50          | A           |    |
| Typical Thermal Resistance (Note 2)  | $R_{\theta JA}$       | 80          | °C/W        |    |
| Operating Junction Temperature Range   | @ $V_{RRM}$ 20V ~50V  | $T_J$       | -55 to +125 | °C |
|  | @ $V_{RRM}$ 60V ~200V | $T_J$       | -55 to +150 | °C |
| Storage Temperature Range  | $T_{STG}$             | -55 to +150 | °C          |    |

Note:

1. Measured at 1MHz And Applied Reverse Voltage Of 4.0V D.C
2. P.C.B. Mounted With 0.20"x0.20"(5.08 x 5.08 mm) Copper Pad Areas

**SMD SCHOTTKY BARRIER RECTIFIER SS2 SERIES CASE SMAF**
**MAXIMUM RATINGS AND ELECTRICAL CHARACTERISTICS FOR DIFFERENT PART CODE**

Ratings At 25 °C Ambient Temperature Unless Otherwise Specified. Single Phase Half-wave 60Hz, resistive Or Inductive Load, For Capacitive Load Current Derate By 20%.

| PART CODE             | Max. Repetitive Peak Reverse Voltage | Max. RMS Voltage | Max. DC Blocking Voltage | Max. Inst. Forward Voltage @ 2.0A | Maximum DC Reverse Current At Rated DC Blocking Voltage |                  | Typical Junction Cap. (Note 1) | Marking List   |                 |                |                |                |
|-----------------------|--------------------------------------|------------------|--------------------------|-----------------------------------|---|------------------|--------------------------------|----------------|-----------------|----------------|----------------|----------------|
|                       |                                      |                  |                          |                                   | @ 25 °C   | @ 100 °C         |                                |                |                 |                |                |                |
|                       |                                      |                  |                          |                                   | V <sub>RRM</sub>  | V <sub>RMS</sub> |                                |                | V <sub>DC</sub> | V <sub>F</sub> | I <sub>R</sub> | C <sub>J</sub> |
|                       |                                      |                  |                          |                                   | V   | V                |                                |                | V               | V              | mA             | pF             |
| SS22F00000S020        | 20                                   | 14               | 20                       | 0.55                              | 0.3   | 10               | 160                            | SS22F          |                 |                |                |                |
| SS23F00000S030        | 30                                   | 21               | 30                       | 0.55                              | 0.3   | 10               | 160                            | SS23F          |                 |                |                |                |
| SS24F00000S040        | 40                                   | 28               | 40                       | 0.55                              | 0.3   | 10               | 160                            | SS24F          |                 |                |                |                |
| SS25F00000S050        | 50                                   | 35               | 50                       | 0.70                              | 0.3   | 10               | 80                             | SS25F          |                 |                |                |                |
| SS26F00000S060        | 60                                   | 42               | 60                       | 0.70                              | 0.3   | 10               | 80                             | SS26F          |                 |                |                |                |
| SS28F00000S080        | 80                                   | 56               | 80                       | 0.85                              | 0.2   | 5.0              | 80                             | SS28F          |                 |                |                |                |
| SS210F0000S100        | 100                                  | 70               | 100                      | 0.85                              | 0.2   | 5.0              | 80                             | SS210F         |                 |                |                |                |
| <b>SS2150F000S150</b> | <b>150</b>                           | <b>105</b>       | <b>150</b>               | <b>0.95</b>                       | <b>0.1</b>  | <b>2.0</b>       | <b>80</b>                      | <b>SS2150F</b> |                 |                |                |                |
| SS2200F000S200        | 200                                  | 140              | 200                      | 0.95                              | 0.1   | 2.0              | 80                             | SS2200F        |                 |                |                |                |

Note:

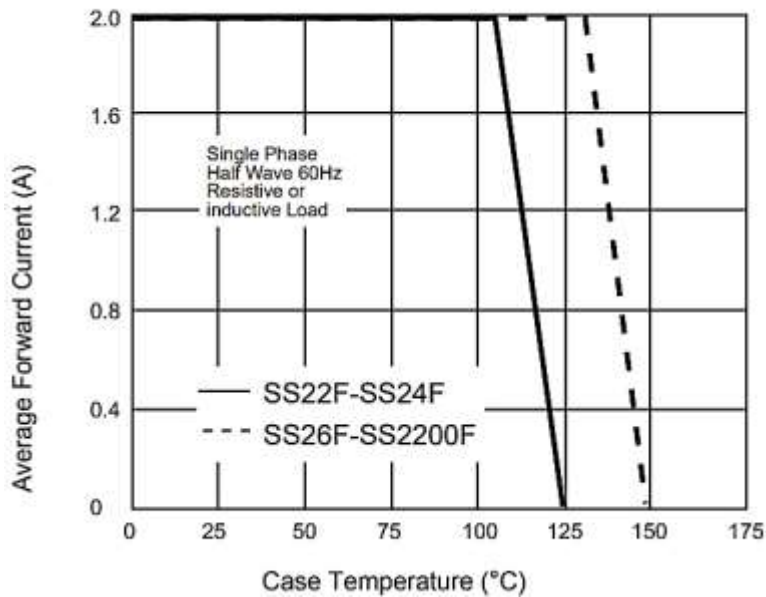
1. Measured at 1MHz And Applied Reverse Voltage Of 4.0V D.C
2. P.C.B. mounted with 0.2"x0.2"(5.08 x 5.08 mm) Copper Pad Areas

5/12/2024

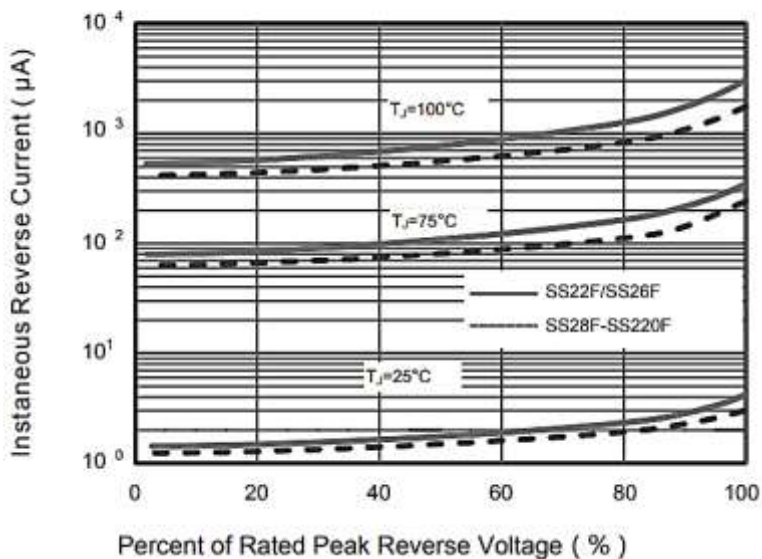
**SMD SCHOTTKY BARRIER RECTIFIER SS2 SERIES CASE SMAF**

**RATINGS AND CHARACTERISTIC CURVES** (For Reference Only)

**Fig.1 Forward Current Derating Curve**



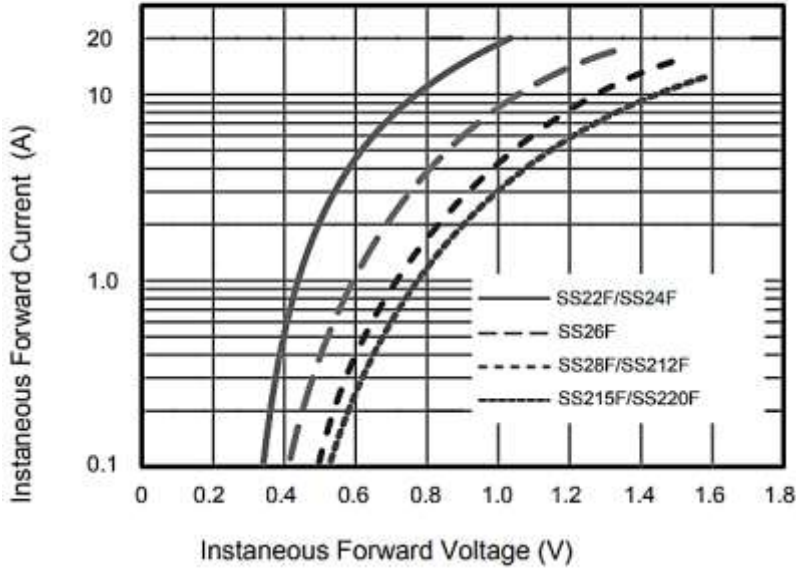
**Fig.2 Typical Reverse Characteristics**



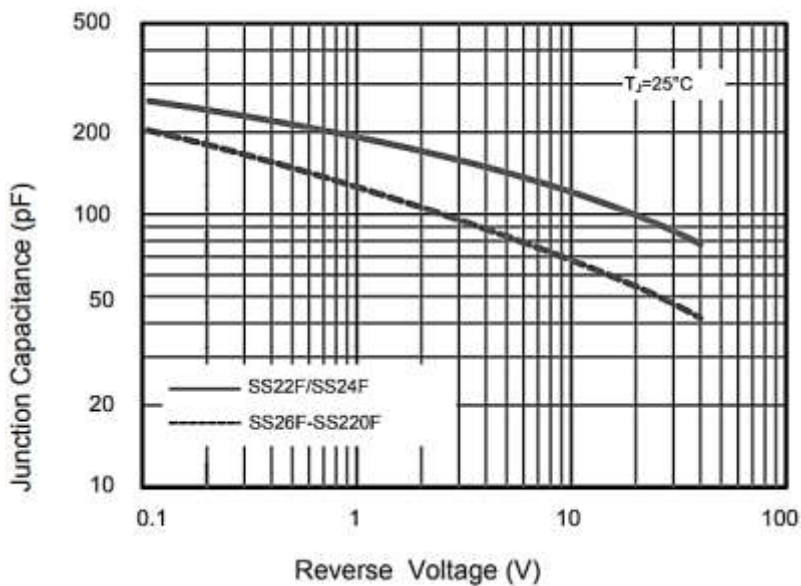
**SMD SCHOTTKY BARRIER RECTIFIER SS2 SERIES CASE SMAF**

**RATINGS AND CHARACTERISTIC CURVES** (For Reference Only)

**Fig.3 Typical Forward Characteristic**



**Fig.4 Typical Junction Capacitance**

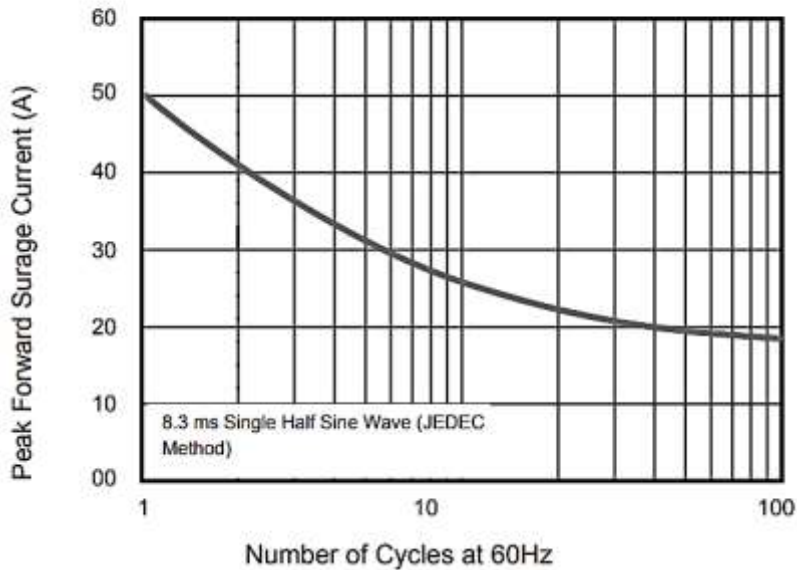




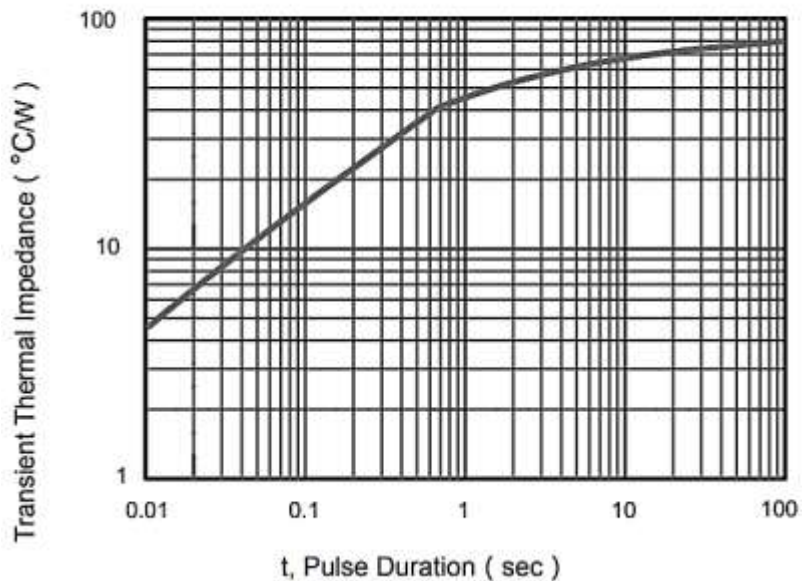
**SMD SCHOTTKY BARRIER RECTIFIER SS2 SERIES CASE SMAF**

**RATINGS AND CHARACTERISTIC CURVES** (For Reference Only)

**Fig.5 Maximum Non-Repetitive Peak Forward Surge Current**

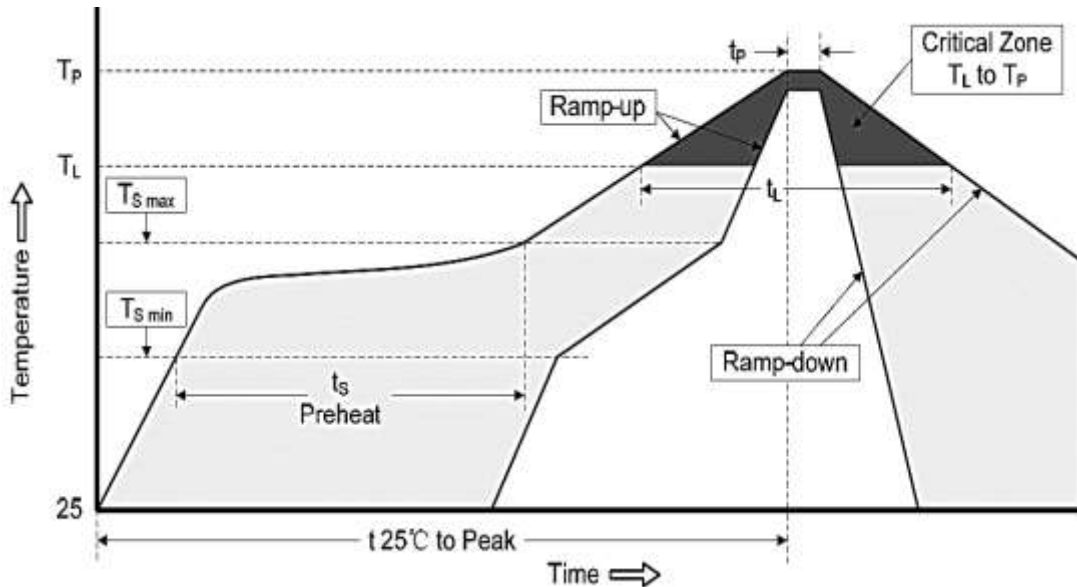


**Fig.6- Typical Transient Thermal Impedance**



**SMD SCHOTTKY BARRIER RECTIFIER SS2 SERIES CASE SMAF**
**RELIABILITY**

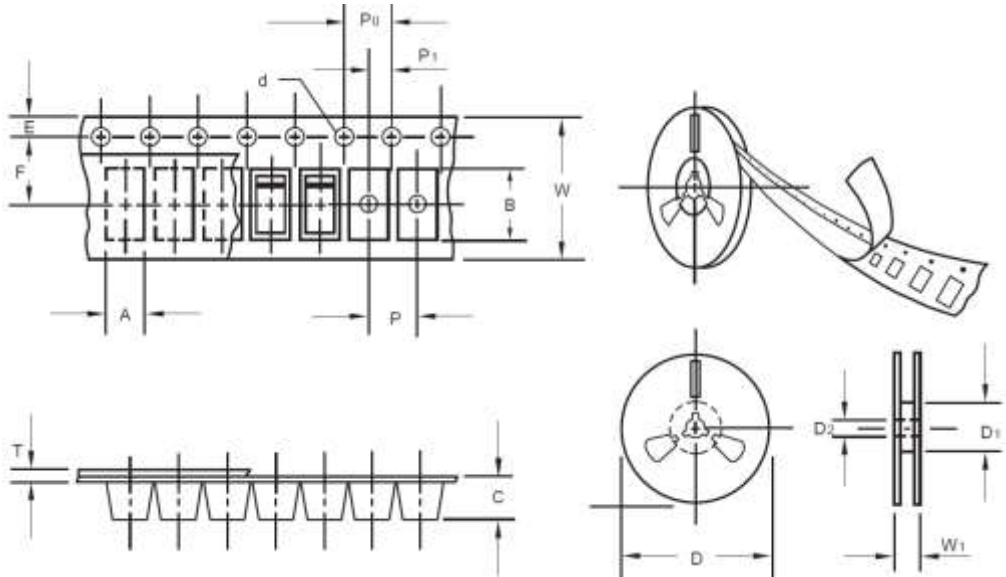
| NUMBER | EXPERIMENT ITEMS                   | EXPERIMENT METHOD AND CONDITIONS   | REFERENCE DOCUMENTS             |
|--------|------------------------------------|--|---------------------------------|
| 1      | Solder Resistance Test             | Test 260°C± 5°C for 10 ± 2 sec.<br>Immerse body into solder 1/16" ± 1/32"                                      | MIL-STD-750D<br>METHOD-2031.2   |
| 2      | Solderability Test                 | 230°C ±5°C for 5 sec.  | MIL-STD-750D<br>METHOD-2026.1 0 |
| 3      | Pull Test                          | 1 kg in axial lead direction for 10 sec.   | MIL-STD-750D<br>METHOD-2036.4   |
| 4      | Bend Test                          | 0.5Kg Weight Applied To Each Lead,<br>Bending Arcs 90 °C ± 5 °C For 3 Times                                    | MIL-STD-750D<br>METHOD-2036.4   |
| 5      | High Temperature Reverse Bias Test | TA=100°C for 1000 Hours at VR=80%<br>Rated VR  | MIL-STD-750D<br>METHOD-1038.4   |
| 6      | Forward Operation Life Test        | TA=25°C Rated Average Rectified<br>Current   | MIL-STD-750D<br>METHOD-1027.3   |
| 7      | Intermittent Operation Life Test   | On state: 5 min with rated IRMS Power<br>Off state: 5 min with Cool Forced Air.<br>On and off for 1000 cycles. | MIL-STD-750D<br>METHOD-1036.3   |
| 8      | Pressure Cooker Test               | 15 PSIG, TA=121°C, 4 hours   | MIL-S-19500<br>APPENOIXC        |
| 9      | Temperature Cycling Test           | -55°C~+125°C; 30 Minutes For Dwelled<br>Time 5 minutes for transferred time.<br>Total: 10 cycles.              | MIL-STD-750D<br>METHOD-1051.7   |
| 10     | Thermal Shock Test                 | 0°C for 5 minutes., 100°C for 5minutes,<br>Total: 10 cycles  | MIL-STD-750D<br>METHOD-1056.7   |
| 11     | Forward Surge Test                 | 8.3ms Single Sale Sine-wave One Surge.   | MIL-STD-750D<br>METHOD-4066.4   |
| 12     | Humidity Test                      | TA=65°C, RH=98% for 1000 hours.  | MIL-STD-750D<br>METHOD-1021.3   |
| 13     | High Temperature Storage life Test | 150°C for 1000 Hours   | MIL-STD-750D<br>METHOD-1031.5   |

**SMD SCHOTTKY BARRIER RECTIFIER SS2 SERIES CASE SMAF**
**SUGGESTED REFLOW PROFILE - For Reference Only**


| PROFILE FEATURE                                 |                           | PB-FREE ASSEMBLY  |
|---|---------------------------|-------------------|
| Average Ramp-up Rate (Ts Max to Tp)             |                           | 3°C/second Max    |
| Preheat   | Temperature Min (Ts Min.) | 150°C             |
|   | Temperature Max (Ts Max.) | 200°C             |
|   | Time (ts Min. to ts Max.) | 60 ~ 180 seconds  |
| Time maintained above                           | Temperature (TL)          | 217°C             |
|   | Time (tL)                 | 60 ~ 150 seconds  |
| Peak/Classification Temperature (Tp)            |                           | 260 °C            |
| Time within 5°C of actual Peak Temperature (tp) |                           | 20 ~ 40 seconds   |
| Ramp-down rate                                  |                           | 6 °C /Second Max. |
| Time 25 °C to Peak Temperature                  |                           | 8 minutes Max.    |
| Suggest reflow times                            |                           | 3 Times Max.      |

**SMD SCHOTTKY BARRIER RECTIFIER SS2 SERIES CASE SMAF**
**TAPE/REEL (Unit: mm)**

All Devices are packed in accordance with EIA standard RS-481-A and specifications.



| ITEM                     | SYMBOL       | TOLERANCE | SMAF   |
|--------------------------|--------------|-----------|--------|
| Carrier width            | A            | 0.1       | 2.80   |
| Carrier Length           | B            | 0.1       | 4.75   |
| Carrier Depth            | C            | 0.1       | 1.42   |
| Sprocket hole            | d            | 0.05      | 1.50   |
| 7" Reel outside diameter | D            | 2.0       | 178.00 |
| 7" Reel inner diameter   | D1           | Min.      | 54.40  |
| Feed hole diameter       | D2           | 0.5       | 13.00  |
| Sprocket hole position   | E            | 0.1       | 1.75   |
| Punch hole position      | F            | 0.1       | 5.50   |
| Punch hole pitch         | P            | 0.1       | 4.00   |
| Sprocket hole pitch      | P0           | 0.1       | 4.00   |
| Embossment center        | P1           | 0.1       | 2.00   |
| Overall tape thickness   | T            | 0.1       | 0.30   |
| Tape width               | W            | 0.3       | 8.00   |
| Reel width               | W1           | 1.0       | 12.30  |
| MPQ/Reel                 | 3000pcs/Reel |           |        |

## SMD SCHOTTKY BARRIER RECTIFIER SS2 SERIES CASE SMAF

### IMPORTANT NOTES AND DISCLAIMER

1. **ROHS COMPLIANCE:** The levels of RoHS restricted materials in this product are below the maximum concentration values (also referred to as the threshold limits) permitted for such substances, or are used in an exempted application, in accordance with EU RoHS Directive (EU) 2015/863 EC (RoHS3). RoHS Test Report for this product can be obtained at Download Center.
2. **REACH COMPLIANCE:** REACH substances of high concern (SVHCs) information is available for this product. Since the European Chemical Agency (ECHA) has published notice of their intent to frequently revise the SVHC listing for the foreseeable future, REACH Test Report for this product can be obtained at Download Center.
3. All Product parametric performance is indicated in the Electrical Characteristics for the listed herein test conditions, unless otherwise noted. Product performance may not be indicated by the Electrical Characteristics if operated under different conditions.
4. NextGen Component, Inc (*NextGen*) reserves the right to make changes to this document and its products and specifications at any time without notice. Customers should obtain and confirm the latest product information and specifications before final design, purchase or use.
5. *NextGen* makes no warranty, representation or guarantee regarding the suitability of its products for any particular purpose, not does *NextGen* assume any liability for application assistance or customer product design.
6. *NextGen* does not warrant or accept any liability with products which are purchased or used for any unintended or unauthorized application. No license is granted by implication or otherwise under any intellectual property rights of NextGen.
7. *NextGen* products are not authorized for use as critical components in life support devices or systems without express written approval by *NextGen*.
8. *NextGen* requires that customers first obtain an RMA (Returned Merchandise Authorization) number prior to returning any products. Returns must be made within 30 days of the date of invoice, be in the original packaging, unused and like-new condition. At the time of quoting or purchasing, a product may say that it is Non-Cancelable/ Non-Returnable (NCNR). These products are not returnable and not refundable.