



SPECIFICATION SHEET

SPECIFICATION SHEET NO.	R0530- ST10100L00S100	
DATE	May 30, 2024	
REVISION	A2	Updated With Most Recent Data
DESCRIPTION AND MAIN PARAMETRICS	<p>SMD Schottky Barrier Rectifier, 3 pads, Case TO-277, ST10 series</p> <p>Repetitive Peak Reverse Voltage 100V Max.</p> <p>Average Rectified Output Current 10A</p> <p>Operating Temp. Range -55°C ~+150°C,</p> <p>Package in Tape/Reel, 5000pcs/Reel</p> <p>RoHS III/REACH Compliant and Halogen Free (HF)</p>	
CUSTOMER		
CUSTOMER PART NO.		
CROSS REF. PART NO.		
ORIGINAL MFG/PART NO.	MDD Diodes/ST10100	
PART CODE	ST10100L00S100	

VENDOR APPROVE			
Issued/Checked/Approved			
DATE: May 30, 2024			

CUSTOMER APPROVE	
DATE:	

SMD SCHOTTKY BARRIER RECTIFIER ST10 SERIES CASE TO-277

MAIN FEATURE

- Trench MOS Schottky Barrier Diodes
- Low Forward Voltage Drop and Low Profile - Typical Body Height 1.1 mm
- Moisture Sensitivity: Level 1, Per J-STD-020
- High Temperature Soldering Guaranteed: 260°C/10 Seconds At Terminals
- Surface Mount Package Ideally Suited For Automatic Insertion
- REACH/RoHS III Complaint And Halogen Free
- Cross Main Competitor Parts In Market



- **APPLICATION**

- For Surface Mounted Applications

ELECTRICAL CHARACTERISTICS

- See Page 4

HOW TO ORDER

- Please Follow Up Part Code Guide And Indicate Pat Code When You Order Or RFQ For Custom Specification

PART CODE GUIDE

RFQ
Request For Quotation

CODE	NAME	KEY SPECIFICATION OPTION
ST10	Product Series Code	SMD Schottky Barrier Rectifier, 3 pads, Forward Current 10A.
100	Reverse Voltage Code	100: 100V
L0	Case Code	L0: Case TO-277
0S	Internal Control Code	Custom letter A~Z, a-z or Digits (0-9)
100	DC Blocking Voltage Code	100: 100V

SMD SCHOTTKY BARRIER RECTIFIER ST10 SERIES CASE TO-277

DIMENSION (Unit: Inch/mm)

Image for reference



Marking: ST10100

TO-277

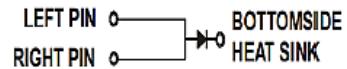
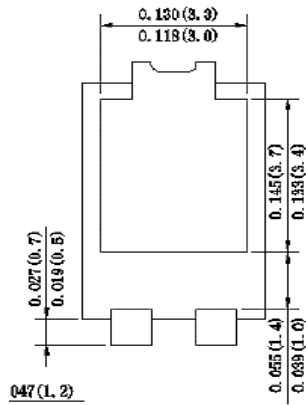
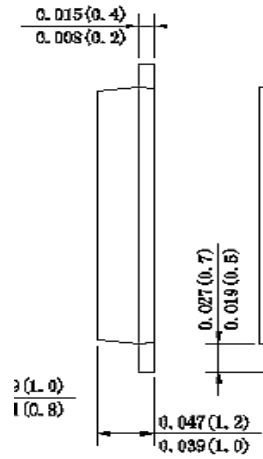
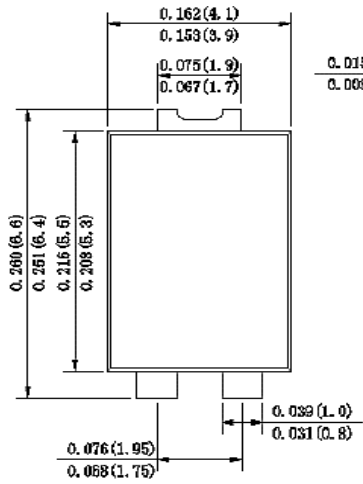

Recommend
Pad Layout

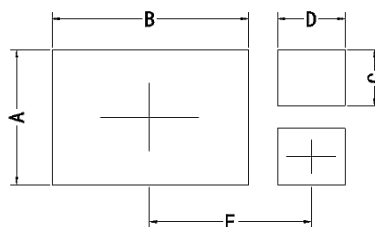

Symbol	Unit (inch)	Unit (mm)
A	0.142	3.60
B	0.211	5.35
C	0.059	1.50
D	0.073	1.85
E	0.169	4.30

SMD SCHOTTKY BARRIER RECTIFIER ST10 SERIES CASE TO-277
MECHANICAL DATA

CASE	TERMINALS	POLARITY	MOUNTING POSITION	WEIGHT PER PIECE
JEDEC TO-277 Molded Plastic Body	Solder Plated, Solderable Per MIL-STD-750, Method 2026	Polarity Symbol Marking On Case	Any	0.0030 Ounce, 0.0920 grams

MAXIMUM RATINGS AND ELECTRICAL CHARACTERISTICS

Ratings at 25 °C ambient temperature unless otherwise specified. Single phase half-wave 60Hz, resistive or inductive load, for capacitive load current derate by 20%.

PARAMETER	SYMBOLS	VALUE	UNITS
Maximum Repetitive Peak Reverse Voltage	VRRM	100	V
Maximum DC Blocking Voltage	VDC	100	V
RMS Reverse Voltage	VRMS	70	V
Average Rectified Output Current	IO	10	A
Non-repetitive Peak Forward Surge 8.3ms Single Half Sine-wave Superimposed On Rated Load (JEDEC Method)	IFSM	240	A

SMD SCHOTTKY BARRIER RECTIFIER ST10 SERIES CASE TO-277
ELECTRICAL CHARACTERISTICS - @ 25 °C

PARAMETER	SYMBOLS	VALUE			UNIT	CONDITION
		MIN.	TYP.	MAX.		
Forward Voltage Drop	V _F	-	0.60	0.65	V	@10A, T _A = 25°C
		-	0.54	0.59	V	@10A, T _A = 125°C
Peak Reverse Current At Rated DC Blocking Voltage	I _R	-	25	70	μA	@T _A = 25°C
		-	10	50	mA	@T _A = 125°C
Typical Junction Capacitance	C _J	240			pF	@ 4.0 V, 1 MHz
Typical Thermal Resistance Junction to Ambient	R _{θJA}	102			°C/W	
Operating Junction Temperature Range	T _J	-55	-	+150	°C	
Storage Temperature Range	T _{STG}	-55	-	+150	°C	

SMD SCHOTTKY BARRIER RECTIFIER ST10 SERIES CASE TO-277

TYPICAL CHARACTERISTIC CURVES - For Reference Only

FIG.1: Forward Output Current Derating Curve

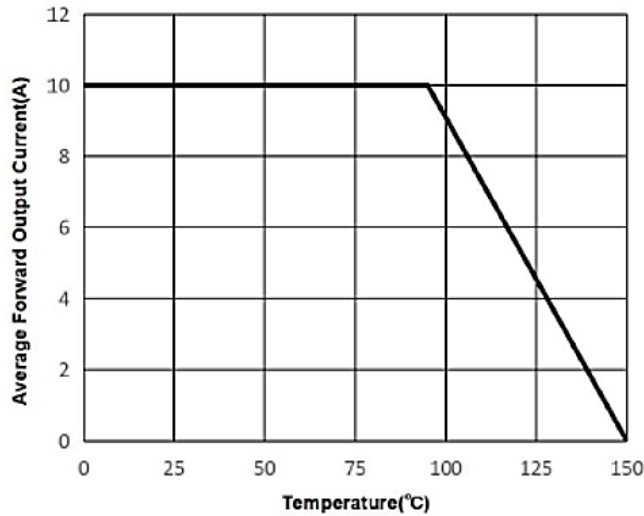
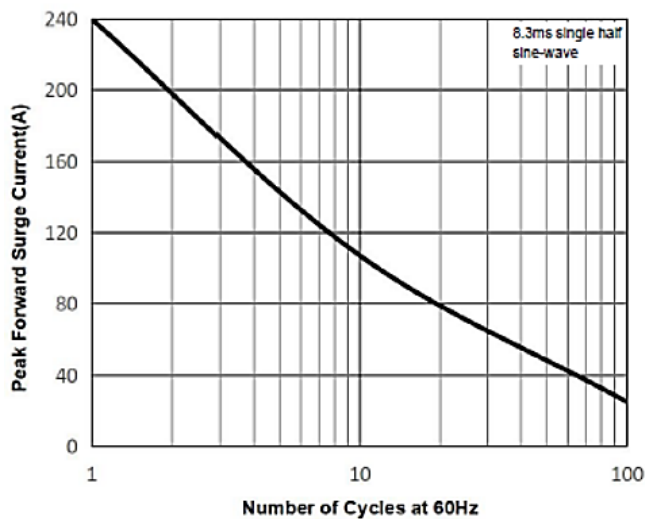

FIG.2: Maximum Non-Repetitive Peak Forward Surge Current



SMD SCHOTTKY BARRIER RECTIFIER ST10 SERIES CASE TO-277

TYPICAL CHARACTERISTIC CURVES - For Reference Only

FIG.3: Typical Forward Characteristics

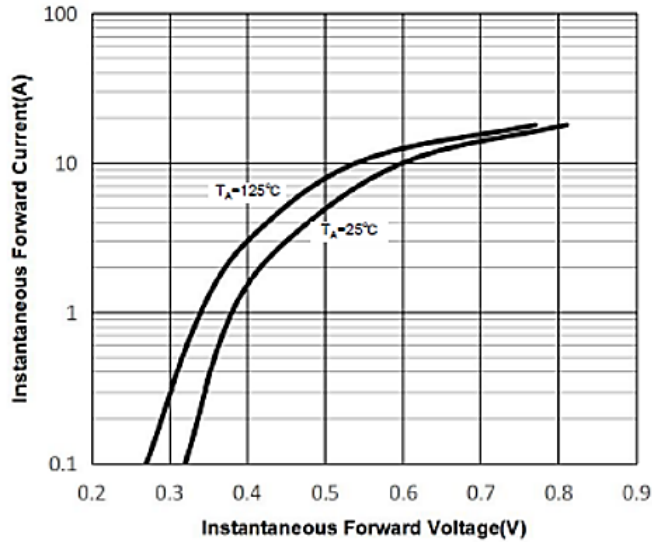
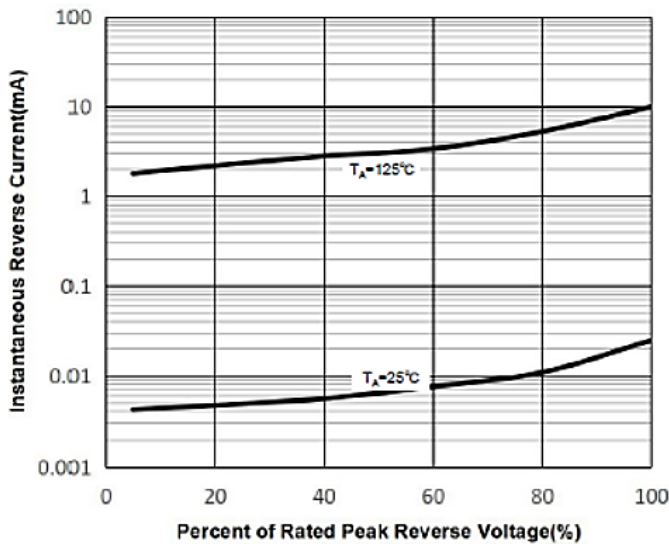

FIG.4: Typical Reverse Characteristics



SMD SCHOTTKY BARRIER RECTIFIER ST10 SERIES CASE TO-277
RELIABILITY

NUMBER	EXPERIMENT ITEMS	EXPERIMENT METHOD AND CONDITIONS	REFERENCE DOCUMENTS
1	Solder Resistance Test	Test 260°C± 5°C for 10 ± 2 sec. Immerse body into solder 1/16" ± 1/32"	MIL-STD-750D METHOD-2031.2
2	Solderability Test	230°C ±5°C for 5 sec.	MIL-STD-750D METHOD-2026.1 0
3	Pull Test	1 kg in axial lead direction for 10 sec.	MIL-STD-750D METHOD-2036.4
4	Bend Test	0.5Kg Weight Applied To Each Lead, Bending Arcs 90 °C ± 5 °C For 3 Times	MIL-STD-750D METHOD-2036.4
5	High Temperature Reverse Bias Test	TA=100°C for 1000 Hours at VR=80% Rated VR	MIL-STD-750D METHOD-1038.4
6	Forward Operation Life Test	TA=25°C Rated Average Rectified Current	MIL-STD-750D METHOD-1027.3
7	Intermittent Operation Life Test	On state: 5 min with rated IRMS Power Off state: 5 min with Cool Forced Air. On and off for 1000 cycles.	MIL-STD-750D METHOD-1036.3
8	Pressure Cooker Test	15 PSIG, TA=121°C, 4 hours	MIL-S-19500 APPENOIXC
9	Temperature Cycling Test	-55°C~+125°C; 30 Minutes For Dwelled Time 5 minutes for transferred time. Total: 10 cycles.	MIL-STD-750D METHOD-1051.7
10	Thermal Shock Test	0°C for 5 minutes., 100°C for 5minutes, Total: 10 cycles	MIL-STD-750D METHOD-1056.7
11	Forward Surge Test	8.3ms Single Sale Sine-wave One Surge.	MIL-STD-750D METHOD-4066.4
12	Humidity Test	TA=65°C, RH=98% for 1000 hours.	MIL-STD-750D METHOD-1021.3
13	High Temperature Storage life Test	150°C for 1000 Hours	MIL-STD-750D METHOD-1031.5

SMD SCHOTTKY BARRIER RECTIFIER ST10 SERIES CASE TO-277

SUGGESTED REFLOW PROFILE - For Reference Only

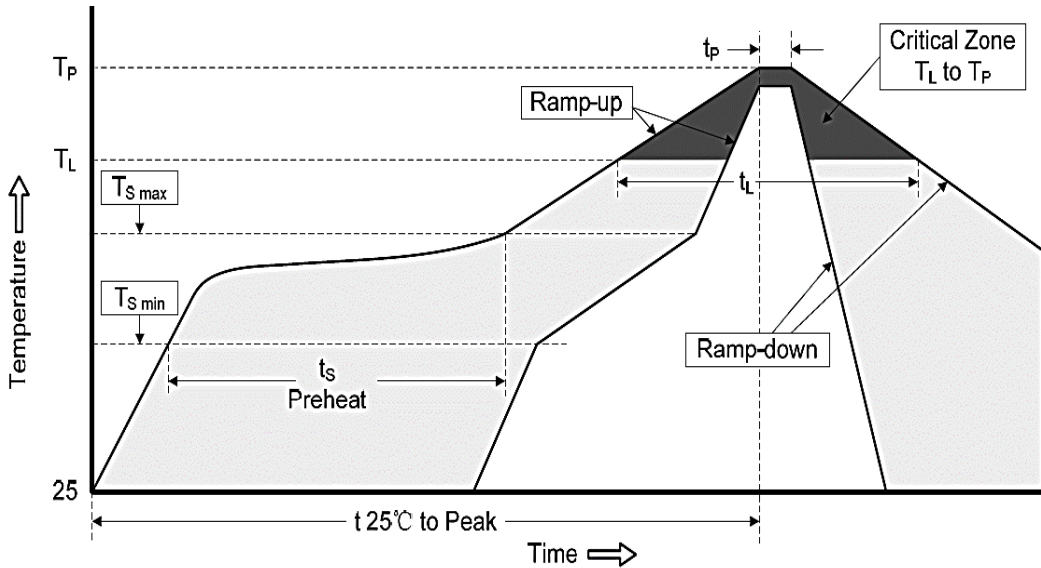

PROFILE FEATURE		PB-FREE ASSEMBLY
Average Ramp-up Rate (Ts Max to Tp)		3°C/second Max
Preheat	Temperature Min (Ts Min.)	150°C
	Temperature Max (Ts Max.)	200°C
	Time (ts Min. to ts Max.)	60 ~ 180 seconds
Time maintained above	Temperature (Tl)	217°C
	Time (tl)	60 ~ 150 seconds
Peak/Classification Temperature (Tp)		260 °C
Time within 5°C of actual Peak Temperature (tp)		20 ~ 40 seconds
Ramp-down rate		6 °C /Second Max.
Time 25 °C to Peak Temperature		8 minutes Max.
Suggest reflow times		3 Times Max.

SMD SCHOTTKY BARRIER RECTIFIER ST10 SERIES CASE TO-277
TAPE/REEL - Unit: mm

All Devices are packed in accordance with EIA standard RS-481-A and specifications.

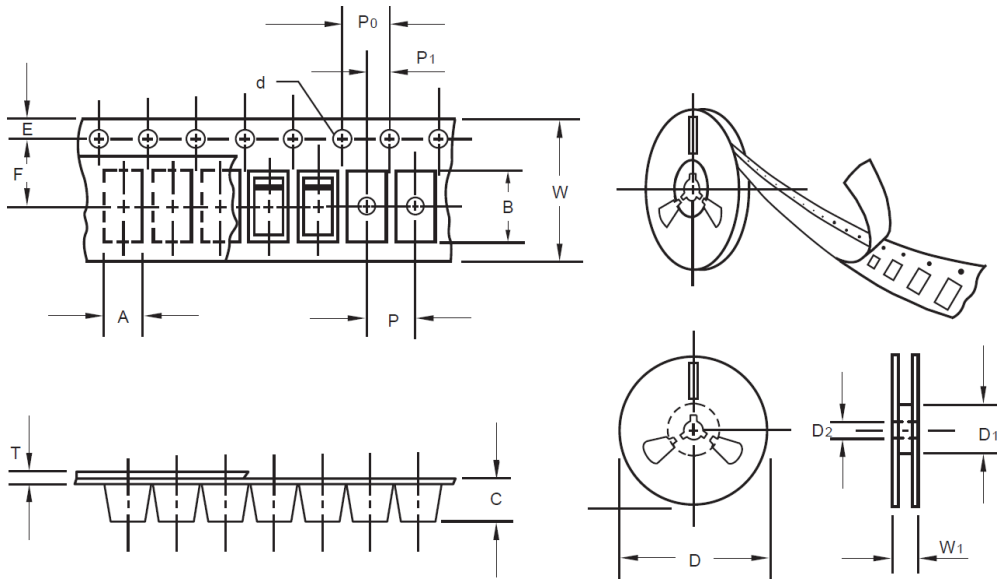

ITEM	SYMBOL	TOLERANCE	TO-277
Carrier width	A	0.1	4.45
Carrier Length	B	0.1	7.0
Carrier Depth	C	0.1	1.60
Sprocket hole	d	0.05	1.55
13" Reel outside diameter	D	2.0	330.00
13" Reel inner diameter	D1	Min.	50.00
Feed hole diameter	D2	0.5	13.00
Sprocket hole position	E	0.1	1.75
Punch hole position	F	0.1	7.50
Punch hole pitch	P	0.1	8.00
Sprocket hole pitch	P0	0.1	4.00
Embossment center	P1	0.1	2.00
Overall tape thickness	T	0.1	0.25
Tape width	W	0.3	12.00
Reel width	W1	1.0	12.30
MPQ/Reel	5000pcs/Reel		

SMD SCHOTTKY BARRIER RECTIFIER ST10 SERIES CASE TO-277

IMPORTANT NOTES AND DISCLAIMER

1. **ROHS COMPLIANCE:** The levels of RoHS restricted materials in this product are below the maximum concentration values (also referred to as the threshold limits) permitted for such substances, or are used in an exempted application, in accordance with EU RoHS Directive (EU) 2015/863 EC (RoHS3). RoHS Test Report for this product can be obtained at Download Center.
2. **REACH COMPLIANCE:** REACH substances of high concern (SVHCs) information is available for this product. Since the European Chemical Agency (ECHA) has published notice of their intent to frequently revise the SVHC listing for the foreseeable future, REACH Test Report for this product can be obtained at Download Center.
3. All Product parametric performance is indicated in the Electrical Characteristics for the listed herein test conditions, unless otherwise noted. Product performance may not be indicated by the Electrical Characteristics if operated under different conditions.
4. NextGen Component, Inc (*NextGen*) reserves the right to make changes to this document and its products and specifications at any time without notice. Customers should obtain and confirm the latest product information and specifications before final design, purchase or use.
5. *NextGen* makes no warranty, representation or guarantee regarding the suitability of its products for any particular purpose, not does *NextGen* assume any liability for application assistance or customer product design.
6. *NextGen* does not warrant or accept any liability with products which are purchased or used for any unintended or unauthorized application. No license is granted by implication or otherwise under any intellectual property rights of NextGen.
7. *NextGen* products are not authorized for use as critical components in life support devices or systems without express written approval by *NextGen*.
8. *NextGen* requires that customers first obtain an RMA (Returned Merchandise Authorization) number prior to returning any products. Returns must be made within 30 days of the date of invoice, be in the original packaging, unused and like-new condition. At the time of quoting or purchasing, a product may say that it is Non-Cancelable/ Non-Returnable (NCNR). These products are not returnable and not refundable.