



SPECIFICATION SHEET

SPECIFICATION SHEET NO.	R0605- SD103BW100S030	
DATE	June 5, 2024	
REVISION	A2	Updated With Most Recent Data
DESCRIPTION AND MAIN PARAMETRICS	<p>SMD Schottky Diodes 2 Pads, Case SOD-123</p> <p>SD103 Series, Repetitive Peak Reverse Voltage 30V Max.</p> <p>Forward Continuous Current 0.35A Max.</p> <p>Operating Temp. Range -55°C ~+125°C</p> <p>Package in Tape/Reel, 3000pcs/Reel</p> <p>RoHS III/REACH Compliant and Halogen Free (HF)</p>	
CUSTOMER		
CUSTOMER PART NO.		
CROSS REF. PART NO.		
ORIGINAL MFG/PART NO.	MDD Diodes/SD103BW	
PART CODE	SD103BW100S030	

VENDOR APPROVE		
Issued/Checked/Approved		
		
DATE: June 5, 2024		

CUSTOMER APPROVE	
DATE:	

SMD SCHOTTKY DIODES SD103 SERIES CASE SOD-123

MAIN FEATURE

- Fast Switching Speed
- Guard Ring Construction For Transient Protection
- Negligible Reverse Recovery Time
- Low Reverse Capacitance
- Surface Mount Package Ideally Suited for Automatic Insertion
- REACH/RoHS III Complaint and Halogen Free
- Cross Main Competitor Parts in Market



APPLICATION

- For SMD application

ELECTRICAL CHARACTERISTICS

- See Page 4~ Page 5 For Different Part Code

HOW TO ORDER

- Please Follow Up Part Code Guide And Indicate Pat Code When You Order Or RFQ For Custom Specification

PART CODE GUIDE

[RFQ](#)
Request For Quotation

CODE	NAME	KEY SPECIFICATION OPTION
SD103	Product Series Code	SMD Schottky Diodes, Forward Current 0.35A
B	Repetitive Peak Reverse Voltage Code	A: 40V Max. ; B: 30V Max.; C: 20V Max.;
W1	Case Code	W0: Case SMF/SOD-123FL; W1: Case SOD-123; WS: Case SOD-323
00S	Internal Control Code	Custom letter A~Z, a-z or Digits (0-9)
030	Working Peak Reverse Voltage Code	020: 20V; 030: 30V; 040: 40V

SMD SCHOTTKY DIODES SD103 SERIES CASE SOD-123

DIMENSION (Unit: Inch/mm)

Image for reference



Marking:

See Page -5 Marking List
For different Part code

SOD-123

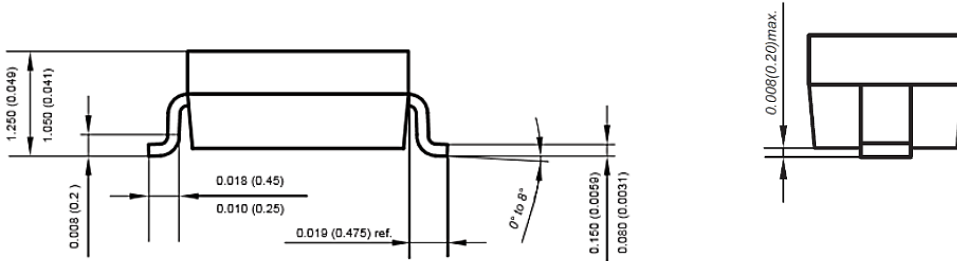
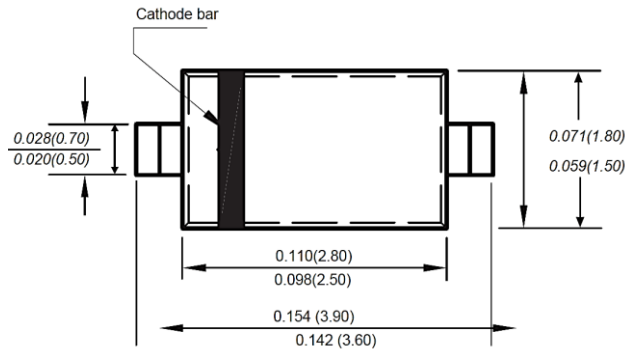

Recommend Pad Layout

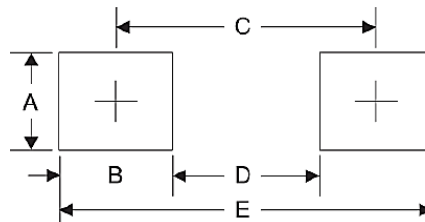

Symbol	Unit (inch)	Unit (mm)
A	0.047	1.20
B	0.047	1.20
C	0.126	3.20
D	0.079	2.00
E	0.173	4.40

SMD SCHOTTKY DIODES SD103 SERIES CASE SOD-123
MECHANICAL DATA

CASE	TERMINALS	POLARITY	MOUNTING POSITION	WEIGHT PER PIECE
JEDEC SOD-123 Molded Plastic Body	Solder plated, Solderable per MIL-STD-750, Method 2026	Polarity Symbol Marking On Case	Any	0.00070 Ounce, 0.02000 Grams

ABSOLUTE MAXIMUM RATINGS - @ 25 °C

PARAMETER	SYMBOLS	VALUE	UNITS
Forward Continuous Current	IFM	0.35	A
Repetitive Peak Forward Current at $\leq 1.0s$	IFRM	1.5	A
Power Dissipation	Pd	400	mW
Thermal Resistance Junction To Ambient	R θ JA	300	°C/W
Operating Junction e Temperature Range	TJ	-55 to +125	°C
Storage Temperature Range	TSTG	-55 to +150	°C

ELECTRICAL CHARACTERISTICS - @ 25 °C

PARAMETER	SYMBOLS	Typ.	UNITS
Capacitance Between Terminals @ VR=0V, f=1.0MHz	Ct	28	pF
Reverse Recovery Time IF=IR=200mA; Irr=0.1XIR, RL=100Ω	trr	10	ns

SMD SCHOTTKY DIODES SD103 SERIES CASE SOD-123
ABSOLUTE MAXIMUM RATINGS - @ 25 °C - FOR DIFFERENT PART CODE

PART CODE	Max. Repetitive Peak Reverse Voltage	Max. RMS Reverse Voltage	Max. Working Peak Reverse Voltage	Max. DC Blocking Voltage
	VRRM	VRMS	VRWM	VDC
	V	V	V	V
SD103CW100S020	20	14	20	20
SD103BW100S030	30	21	30	30
SD103AW100S040	40	28	40	40

ELECTRICAL CHARACTERISTICS - @ 25 °C - FOR DIFFERENT PART CODE

PART CODE	Min. Reverse Breakdown Voltage Reverse	Max. Forward Voltage		Max. Reverse Current	Marking List
	@IR=100µA	@IF=20mA	@IF=200mA		
	VBRR	VF		IRM	
	V	V		µA	
SD103CW100S020	20	0.37	0.6	5.0 @VR=10V	S6
SD103BW100S030	30	0.37	0.6	5.0 @VR=20V	S5
SD103AW100S040	40	0.37	0.6	5.0 @VR=30V	S4

SMD SCHOTTKY DIODES SD103 SERIES CASE SOD-123

TYPICAL CHARACTERISTIC CURVES - For Reference Only

Fig.1 Power Derating Curve

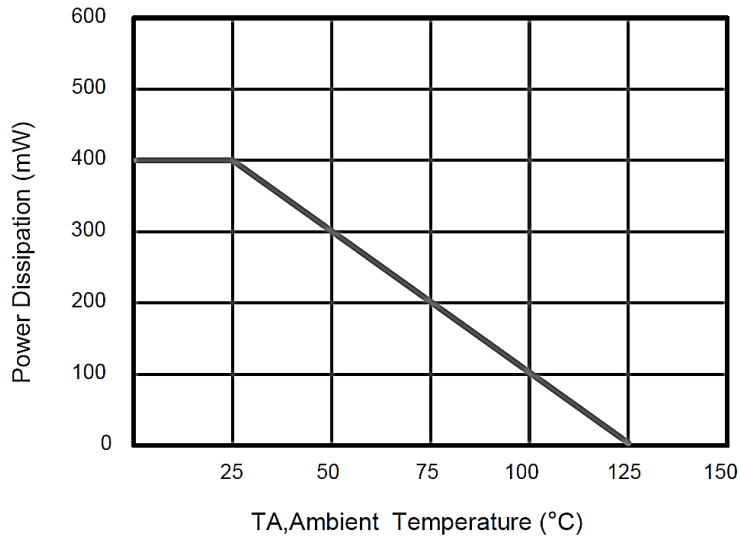
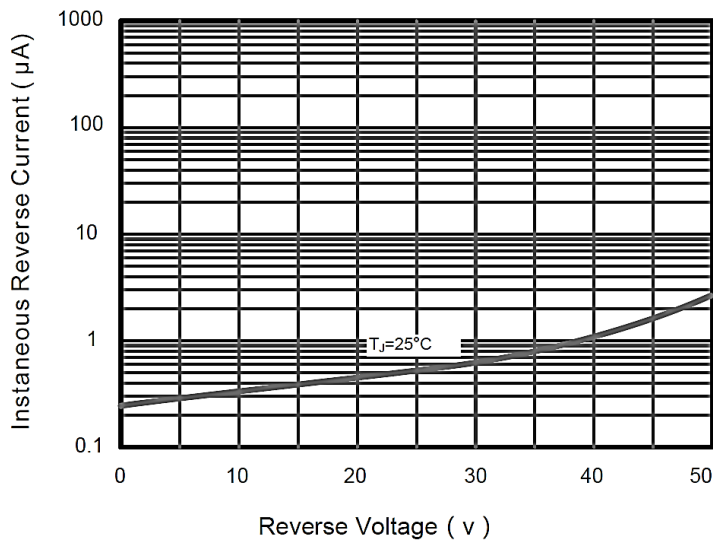

Fig.2 Typical Reverse Characteristics



SMD SCHOTTKY DIODES SD103 SERIES CASE SOD-123

TYPICAL CHARACTERISTIC CURVES - For Reference Only

Fig.3 Forward Characteristics

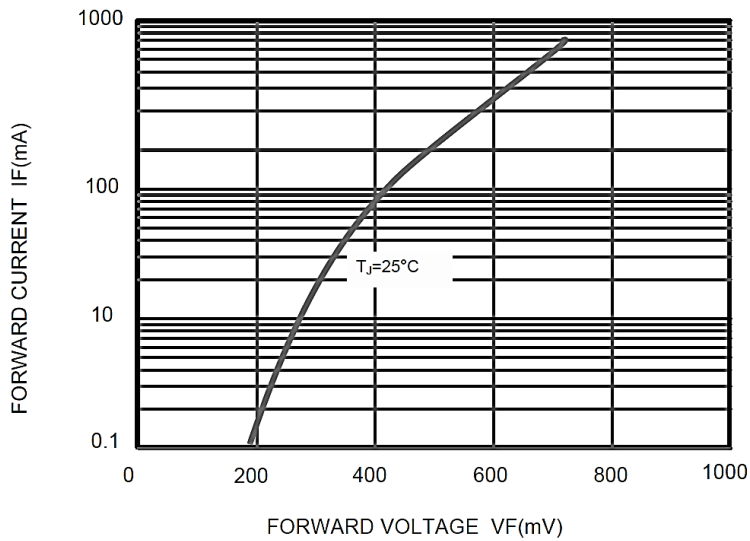
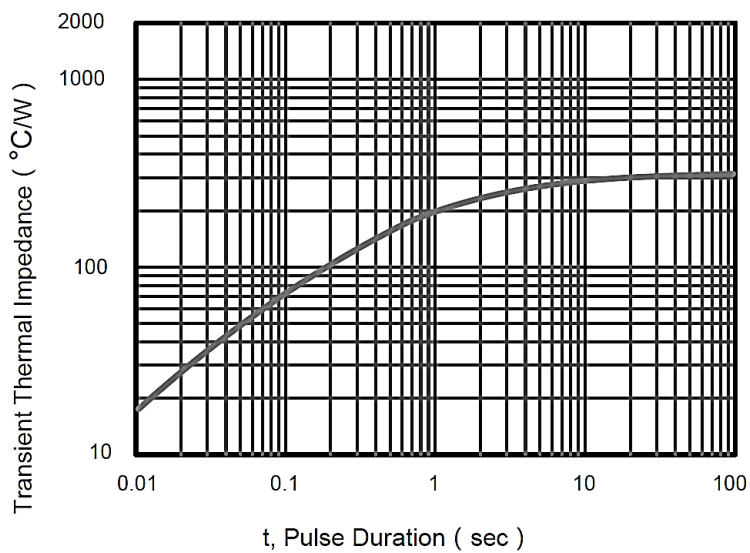

Fig.4 Typical Transient Thermal Impedance



SMD SCHOTTKY DIODES SD103 SERIES CASE SOD-123

TYPICAL CHARACTERISTIC CURVES - For Reference Only

Fig.5 Typical Junction Capacitance

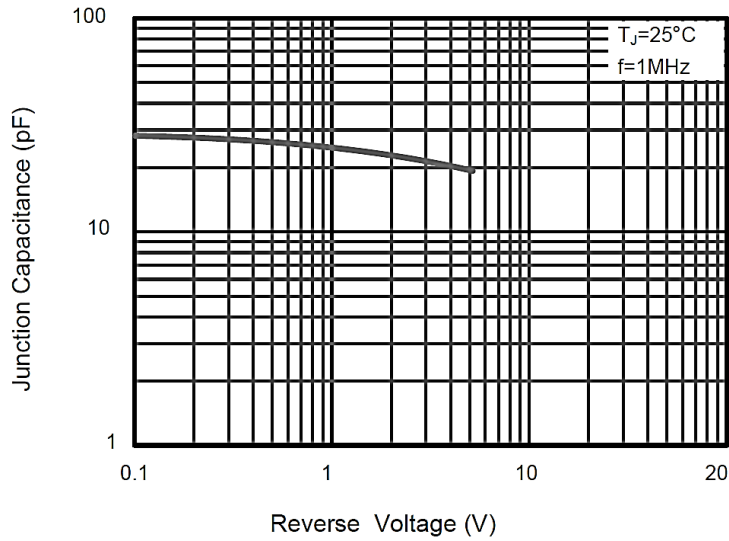

SMD SCHOTTKY DIODES SD103 SERIES CASE SOD-123
RELIABILITY

NUMBER	EXPERIMENT ITEMS	EXPERIMENT METHOD AND CONDITIONS	REFERENCE DOCUMENTS
1	Solder Resistance Test	Test 260°C± 5°C for 10 ± 2 sec. Immerse body into solder 1/16" ± 1/32"	MIL-STD-750D METHOD-2031.2
2	Solderability Test	230°C ±5°C for 5 sec.	MIL-STD-750D METHOD-2026.1 0
3	Pull Test	1 kg in axial lead direction for 10 sec.	MIL-STD-750D METHOD-2036.4
4	Bend Test	0.5Kg Weight Applied To Each Lead, Bending Arcs 90 °C ± 5 °C For 3 Times	MIL-STD-750D METHOD-2036.4
5	High Temperature Reverse Bias Test	TA=100°C for 1000 Hours at VR=80% Rated VR	MIL-STD-750D METHOD-1038.4
6	Forward Operation Life Test	TA=25°C Rated Average Rectified Current	MIL-STD-750D METHOD-1027.3
7	Intermittent Operation Life Test	On state: 5 min with rated IRMS Power Off state: 5 min with Cool Forced Air. On and off for 1000 cycles.	MIL-STD-750D METHOD-1036.3
8	Pressure Cooker Test	15 PSIG, TA=121°C, 4 hours	MIL-S-19500 APPENOIXC
9	Temperature Cycling Test	-55°C~+125°C; 30 Minutes For Dwelled Time 5 minutes for transferred time. Total: 10 cycles.	MIL-STD-750D METHOD-1051.7
10	Thermal Shock Test	0°C for 5 minutes., 100°C for 5minutes, Total: 10 cycles	MIL-STD-750D METHOD-1056.7
11	Forward Surge Test	8.3ms Single Sale Sine-wave One Surge.	MIL-STD-750D METHOD-4066.4
12	Humidity Test	TA=65°C, RH=98% for 1000 hours.	MIL-STD-750D METHOD-1021.3
13	High Temperature Storage life Test	150°C for 1000 Hours	MIL-STD-750D METHOD-1031.5

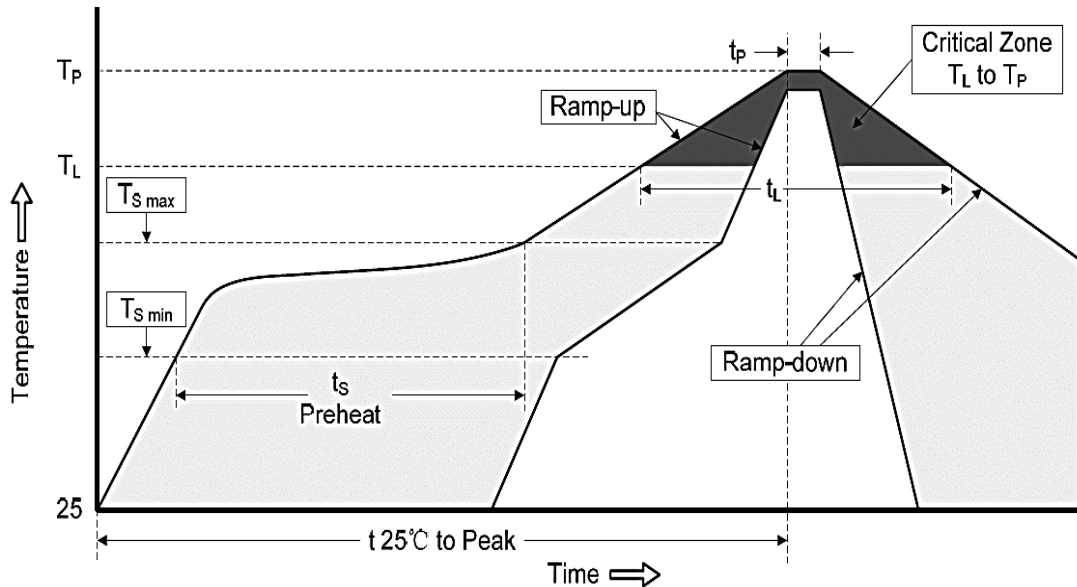
SMD SCHOTTKY DIODES SD103 SERIES CASE SOD-123
SUGGESTED REFLOW PROFILE - For Reference Only

PROFILE FEATURE		PB-FREE ASSEMBLY
Average Ramp-up Rate (Ts Max to Tp)		3°C/second Max
Preheat	Temperature Min (Ts Min.)	150°C
	Temperature Max (Ts Max.)	200°C
	Time (ts Min. to ts Max.)	60 ~ 180 seconds
Time maintained above	Temperature (TL)	217°C
	Time (tL)	60 ~ 150 seconds
Peak/Classification Temperature (Tp)		260 °C
Time within 5°C of actual Peak Temperature (tp)		20 ~ 40 seconds
Ramp-down rate		6 °C /Second Max.
Time 25 °C to Peak Temperature		8 minutes Max.
Suggest reflow times		3 Times Max.

SMD SCHOTTKY DIODES SD103 SERIES CASE SOD-123
TAPE/REEL - Unit: mm

All Devices are packed in accordance with EIA standard RS-481-A and specifications.

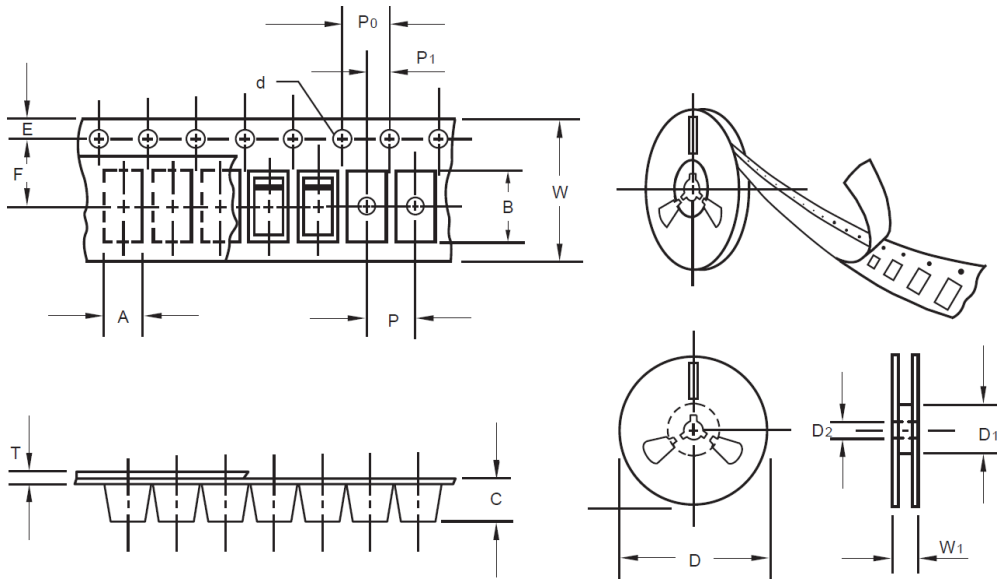

ITEM	SYMBOL	TOLERANCE	SOD-123
Carrier width	A	0.1	2.10
Carrier Length	B	0.1	4.00
Carrier Depth	C	0.1	1.60
Sprocket hole	d	0.05	1.55
7" Reel outside diameter	D	2.0	178.00
7" Reel inner diameter	D1	Min.	50.00
Feed hole diameter	D2	0.5	13.00
Sprocket hole position	E	0.1	1.75
Punch hole position	F	0.1	3.50
Punch hole pitch	P	0.1	4.00
Sprocket hole pitch	P0	0.1	4.00
Embossment center	P1	0.1	2.00
Overall tape thickness	T	0.1	0.25
Tape width	W	0.3	8.15
Reel width	W1	1.0	10.50
MPQ/Reel	3000pcs/Reel		

SMD SCHOTTKY DIODES SD103 SERIES CASE SOD-123

IMPORTANT NOTES AND DISCLAIMER

1. **ROHS COMPLIANCE:** The levels of RoHS restricted materials in this product are below the maximum concentration values (also referred to as the threshold limits) permitted for such substances, or are used in an exempted application, in accordance with EU RoHS Directive (EU) 2015/863 EC (RoHS3). RoHS Test Report for this product can be obtained at Download Center.
2. **REACH COMPLIANCE:** REACH substances of high concern (SVHCs) information is available for this product. Since the European Chemical Agency (ECHA) has published notice of their intent to frequently revise the SVHC listing for the foreseeable future, REACH Test Report for this product can be obtained at Download Center.
3. All Product parametric performance is indicated in the Electrical Characteristics for the listed herein test conditions, unless otherwise noted. Product performance may not be indicated by the Electrical Characteristics if operated under different conditions.
4. NextGen Component, Inc (*NextGen*) reserves the right to make changes to this document and its products and specifications at any time without notice. Customers should obtain and confirm the latest product information and specifications before final design, purchase or use.
5. *NextGen* makes no warranty, representation or guarantee regarding the suitability of its products for any particular purpose, not does *NextGen* assume any liability for application assistance or customer product design.
6. *NextGen* does not warrant or accept any liability with products which are purchased or used for any unintended or unauthorized application. No license is granted by implication or otherwise under any intellectual property rights of NextGen.
7. *NextGen* products are not authorized for use as critical components in life support devices or systems without express written approval by *NextGen*.
8. *NextGen* requires that customers first obtain an RMA (Returned Merchandise Authorization) number prior to returning any products. Returns must be made within 30 days of the date of invoice, be in the original packaging, unused and like-new condition. At the time of quoting or purchasing, a product may say that it is Non-Cancelable/ Non-Returnable (NCNR). These products are not returnable and not refundable.