



**SPECIFICATION SHEET**

<b>SPECIFICATION SHEET NO.</b>	R0605- B5819WS000S040	
<b>DATE</b>	June 5, 2024	
<b>REVISION</b>	A2	Updated With Most Recent Data
<b>DESCRIPTION AND MAIN PARAMETRICS</b>	<p>SMD Schottky Diodes 2 Pads, Case SOD-323          B581 Series, Repetitive Peak Reverse Voltage 40V Max.          Average Rectified Output Current 1.0A Max.          Operating Temp. Range -55°C ~+125°C          Package in Tape/Reel, 3000pcs/Reel          RoHS III/REACH Compliant and Halogen Free (HF)</p>	
<b>CUSTOMER</b>		
<b>CUSTOMER PART NO.</b>		
<b>CROSS REF. PART NO.</b>		
<b>ORIGINAL MFG/PART NO.</b>	MDD Diodes/B5819WS	
<b>PART CODE</b>	B5819WS000S040	

<b>VENDOR APPROVE</b>			
Issued/Checked/Approved			
DATE: June 5, 2024			

<b>CUSTOMER APPROVE</b>	
DATE:	

**SMD SCHOTTKY DIODES B581 SERIES CASE SOD-323**

**MAIN FEATURE**

- Fast Switching Speed
- Conductance
- Surface Mount Package Ideally Suited for Automatic Insertion
- REACH/RoHS III Complaint and Halogen Free
- Cross Main Competitor Parts in Market



**APPLICATION**

- For Use In Low Voltage, High Frequency Inverters
- For Free Wheeling and Polanty Protection Applications

**ELECTRICAL CHARACTERISTICS**

- See Page 4~ Page 5 For Different Part Code

**HOW TO ORDER**

- Please Follow Up Part Code Guide And Indicate Pat Code When You Order Or RFQ For Custom Specification

**RFQ**  
Request For Quotation

**PART CODE GUIDE**

CODE	NAME	KEY SPECIFICATION OPTION
B581	Product Series Code	SMD Schottky Diodes, Forward Current 1.0A
9	Repetitive Peak Reverse Voltage Code	7: 20V Max. ; 8: 30V Max.; 9: 40V Max.;
WS	Case Code	W0: Case SMF/SOD-123FL; W1: Case SOD-123; WS: Case SOD-323
00S	Internal Control Code	Custom letter A~Z, a-z or Digits (0-9)
040	DC Blocking Voltage Code	020: 20V; 030: 30V; 040: 40V;

**SMD SCHOTTKY DIODES B581 SERIES CASE SOD-323**

**DIMENSION** (Unit: Inch/mm)

Image for reference



**Marking:**

See Page -5 Marking List  
For different Part code

SOD-323

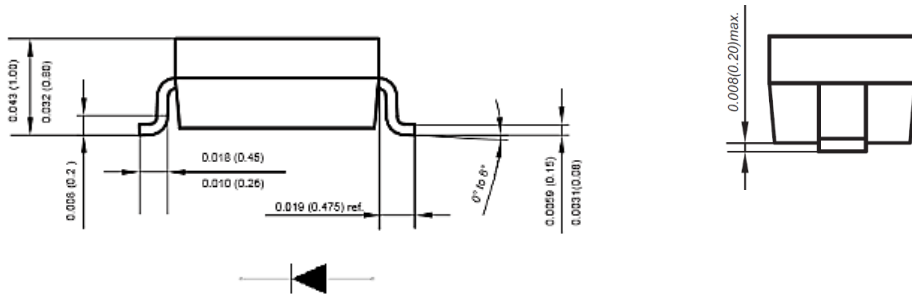
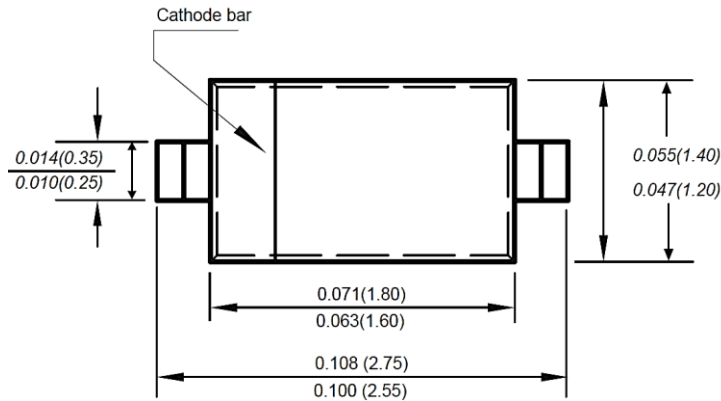

**Recommend Pad Layout**

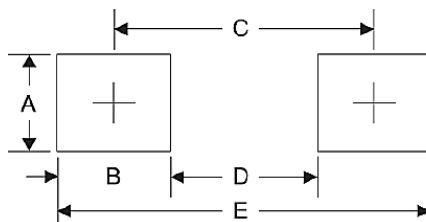

Symbol	Unit (inch)	Unit (mm)
A	0.028	0.70
B	0.028	0.70
C	0.085	2.15
D	0.071	1.80
E	0.112	2.85

**SMD SCHOTTKY DIODES B581 SERIES CASE SOD-323**
**MECHANICAL DATA**

CASE	TERMINALS	POLARITY	MOUNTING POSITION	WEIGHT PER PIECE
JEDEC SOD-323 Molded Plastic Body	Solder plated, Solderable per MIL-STD-750, Method 2026	Polarity Symbol Marking On Case	Any	0.00019 Ounce, 0.00548 Grams

**ABSOLUTE MAXIMUM RATINGS - @ 25 °C**

PARAMETER	SYMBOLS	VALUE	UNITS
Average Rectified Output Current	I <sub>o</sub>	1.0	A
Peak Forward Surge Current at 8.3ms	I <sub>FSM</sub>	25	A
Power Dissipation	P <sub>d</sub>	500	mW
Thermal Resistance Junction To Ambient	R <sub>θJA</sub>	200	°C/W
Operating Junction Temperature Range	T <sub>J</sub>	-55 to +125	°C
Storage Temperature Range	T <sub>STG</sub>	-55 to +125	°C

**ABSOLUTE MAXIMUM RATINGS - @ 25 °C - FOR DIFFERENT PART CODE**

PART CODE	Repetitive Peak Reverse Voltage	Working Peak	DC Blocking Voltage	RMS Voltage	Non-Repetitive Peak Reverse Voltage
	V <sub>RRM</sub>	V <sub>RWM</sub>	V <sub>R</sub>	V <sub>R(R)MS</sub>	V <sub>RM</sub>
	V	V	V	V	V
B5817WS000S020	20	20	20	14	20
B5818WS000S030	30	30	30	21	30
<b>B5819WS000S040</b>	<b>40</b>	<b>40</b>	<b>40</b>	<b>28</b>	<b>40</b>

**SMD SCHOTTKY DIODES B581 SERIES CASE SOD-323**

**CHARACTERISTICS - @ 25 °C - FOR DIFFERENT PART CODE**

PART CODE	Min. Reverse Breakdown Voltage	Max. Reverse Voltage Leakage Current	Max. Forward Voltage		Diode Capacitance	Marking List
	@1mA	@VR	@1A	@3A	@VR=4V,f=1.0MHz	
	V(BR)	IR	VF		Cd	
	V	mA	V		pF	
B5817WS000S020	20	1.0	0.45	0.75	110	SJ
B5818WS000S030	30	1.0	0.55	0.875	110	SK
<b>B5819WS000S040</b>	<b>40</b>	<b>1.0</b>	<b>0.60</b>	<b>0.90</b>	<b>110</b>	<b>SL</b>

**SMD SCHOTTKY DIODES B581 SERIES CASE SOD-323**

TYPICAL CHARACTERISTIC CURVES - For Reference Only

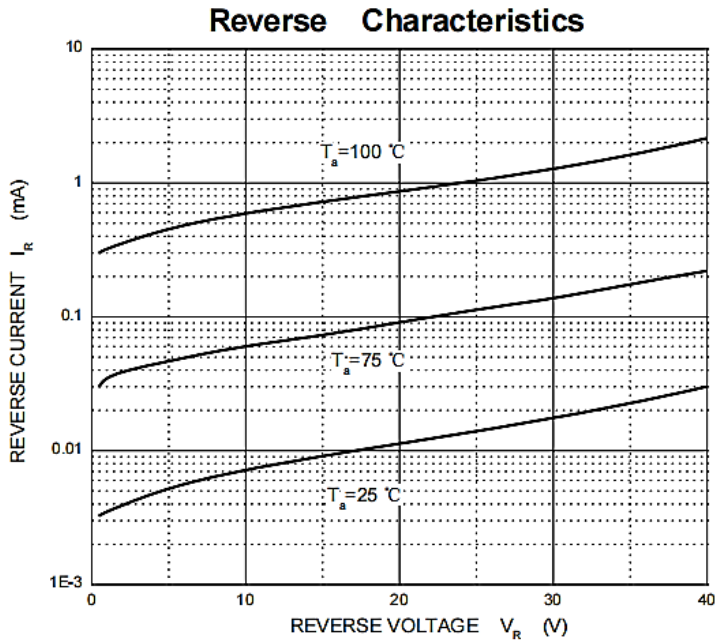
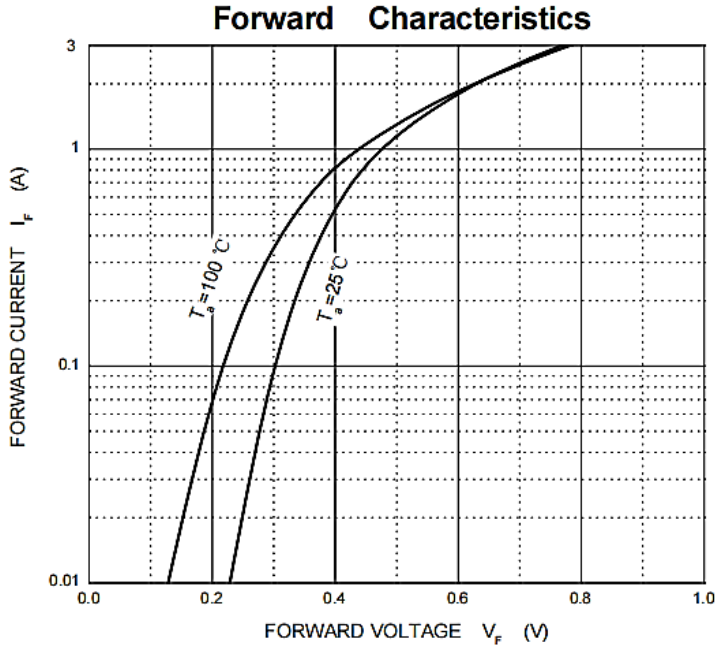

**SMD SCHOTTKY DIODES B581 SERIES CASE SOD-323**

TYPICAL CHARACTERISTIC CURVES - For Reference Only

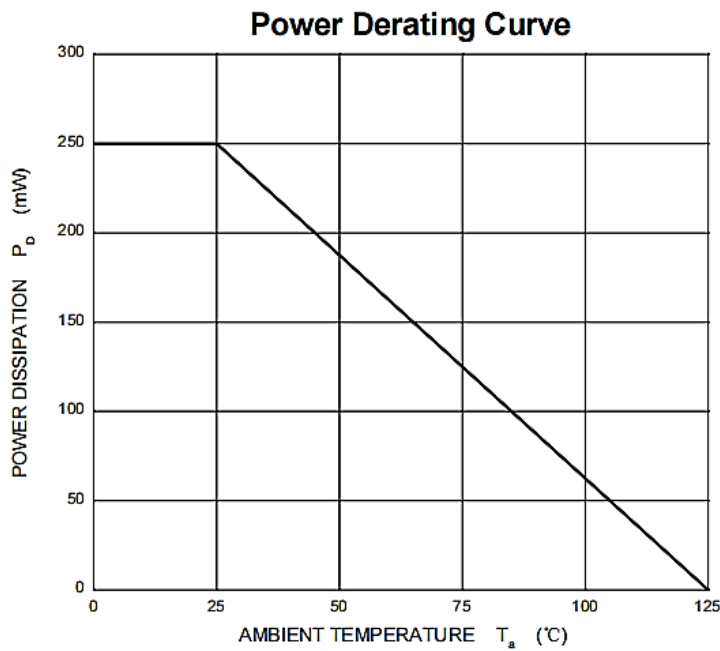
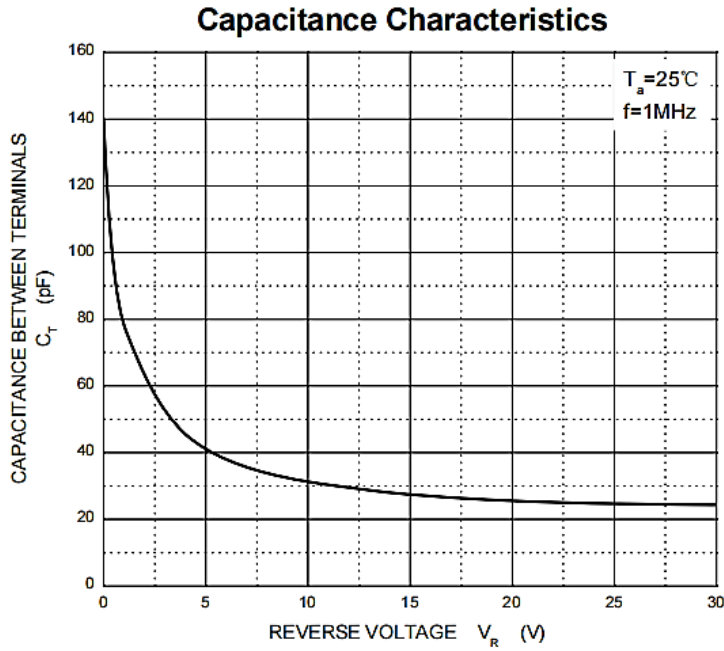

**SMD SCHOTTKY DIODES B581 SERIES CASE SOD-323**
**RELIABILITY**

NUMBER	EXPERIMENT ITEMS	EXPERIMENT METHOD AND CONDITIONS	REFERENCE DOCUMENTS
1	Solder Resistance Test	Test 260°C± 5°C for 10 ± 2 sec. Immerse body into solder 1/16" ± 1/32"	MIL-STD-750D METHOD-2031.2
2	Solderability Test	230°C ±5°C for 5 sec.	MIL-STD-750D METHOD-2026.1 0
3	Pull Test	1 kg in axial lead direction for 10 sec.	MIL-STD-750D METHOD-2036.4
4	Bend Test	0.5Kg Weight Applied To Each Lead, Bending Arcs 90 °C ± 5 °C For 3 Times	MIL-STD-750D METHOD-2036.4
5	High Temperature Reverse Bias Test	TA=100°C for 1000 Hours at VR=80% Rated VR	MIL-STD-750D METHOD-1038.4
6	Forward Operation Life Test	TA=25°C Rated Average Rectified Current	MIL-STD-750D METHOD-1027.3
7	Intermittent Operation Life Test	On state: 5 min with rated IRMS Power Off state: 5 min with Cool Forced Air. On and off for 1000 cycles.	MIL-STD-750D METHOD-1036.3
8	Pressure Cooker Test	15 PSIG, TA=121°C, 4 hours	MIL-S-19500 APPENOIXC
9	Temperature Cycling Test	-55°C~+125°C; 30 Minutes For Dwelled Time 5 minutes for transferred time. Total: 10 cycles.	MIL-STD-750D METHOD-1051.7
10	Thermal Shock Test	0°C for 5 minutes., 100°C for 5minutes, Total: 10 cycles	MIL-STD-750D METHOD-1056.7
11	Forward Surge Test	8.3ms Single Sale Sine-wave One Surge.	MIL-STD-750D METHOD-4066.4
12	Humidity Test	TA=65°C, RH=98% for 1000 hours.	MIL-STD-750D METHOD-1021.3
13	High Temperature Storage life Test	150°C for 1000 Hours	MIL-STD-750D METHOD-1031.5

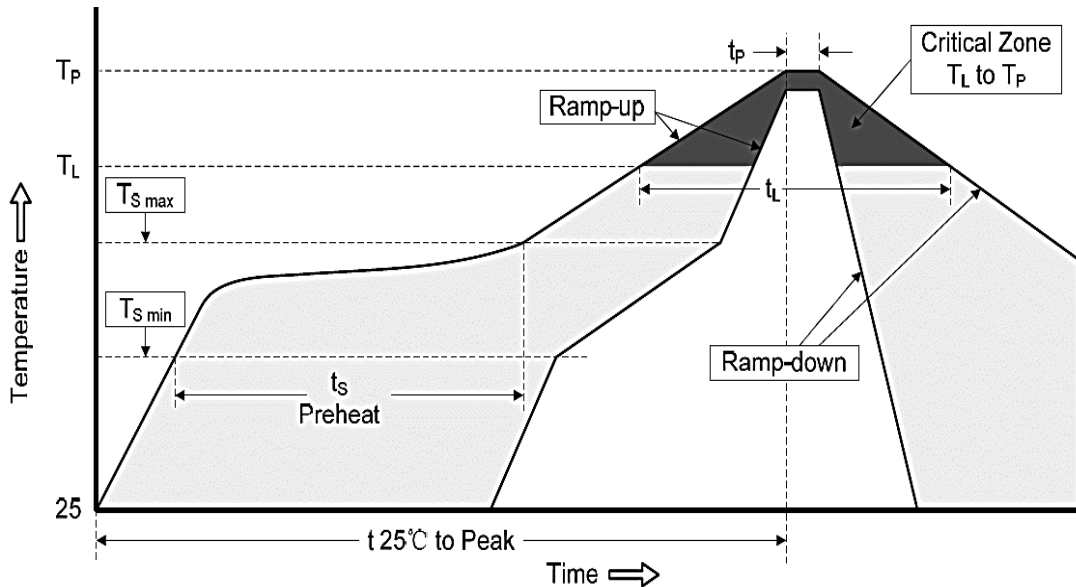

**SMD SCHOTTKY DIODES B581 SERIES CASE SOD-323**
**SUGGESTED REFLOW PROFILE - For Reference Only**

PROFILE FEATURE		PB-FREE ASSEMBLY
Average Ramp-up Rate (Ts Max to Tp)		3°C/second Max
Preheat	Temperature Min (Ts Min.)	150°C
	Temperature Max (Ts Max.)	200°C
	Time (ts Min. to ts Max.)	60 ~ 180 seconds
Time maintained above	Temperature (Tl)	217°C
	Time (tl)	60 ~ 150 seconds
Peak/Classification Temperature (Tp)		260 °C
Time within 5°C of actual Peak Temperature (tp)		20 ~ 40 seconds
Ramp-down rate		6 °C /Second Max.
Time 25 °C to Peak Temperature		8 minutes Max.
Suggest reflow times		3 Times Max.

**SMD SCHOTTKY DIODES B581 SERIES CASE SOD-323**
**TAPE/REEL - Unit: mm**

All Devices are packed in accordance with EIA standard RS-481-A and specifications.

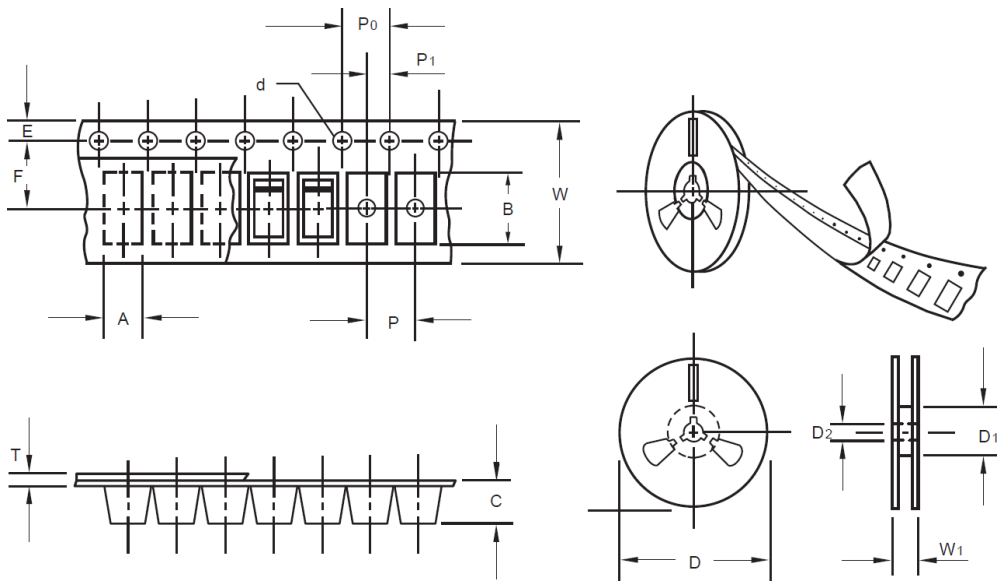

ITEM	SYMBOL	TOLERANCE	SOD-323
Carrier width	A	0.1	2.10
Carrier Length	B	0.1	4.00
Carrier Depth	C	0.1	1.60
Sprocket hole	d	0.05	1.55
7" Reel outside diameter	D	2.0	178.00
7" Reel inner diameter	D1	Min.	50.00
Feed hole diameter	D2	0.5	13.00
Sprocket hole position	E	0.1	1.75
Punch hole position	F	0.1	3.50
Punch hole pitch	P	0.1	4.00
Sprocket hole pitch	P0	0.1	4.00
Embossment center	P1	0.1	2.00
Overall tape thickness	T	0.1	0.25
Tape width	W	0.3	8.15
Reel width	W1	1.0	10.50
MPQ/Reel	3000pcs/Reel		

## SMD SCHOTTKY DIODES B581 SERIES CASE SOD-323

### IMPORTANT NOTES AND DISCLAIMER

1. **ROHS COMPLIANCE:** The levels of RoHS restricted materials in this product are below the maximum concentration values (also referred to as the threshold limits) permitted for such substances, or are used in an exempted application, in accordance with EU RoHS Directive (EU) 2015/863 EC (RoHS3). RoHS Test Report for this product can be obtained at Download Center.
2. **REACH COMPLIANCE:** REACH substances of high concern (SVHCs) information is available for this product. Since the European Chemical Agency (ECHA) has published notice of their intent to frequently revise the SVHC listing for the foreseeable future, REACH Test Report for this product can be obtained at Download Center.
3. All Product parametric performance is indicated in the Electrical Characteristics for the listed herein test conditions, unless otherwise noted. Product performance may not be indicated by the Electrical Characteristics if operated under different conditions.
4. NextGen Component, Inc (*NextGen*) reserves the right to make changes to this document and its products and specifications at any time without notice. Customers should obtain and confirm the latest product information and specifications before final design, purchase or use.
5. *NextGen* makes no warranty, representation or guarantee regarding the suitability of its products for any particular purpose, not does *NextGen* assume any liability for application assistance or customer product design.
6. *NextGen* does not warrant or accept any liability with products which are purchased or used for any unintended or unauthorized application. No license is granted by implication or otherwise under any intellectual property rights of NextGen.
7. *NextGen* products are not authorized for use as critical components in life support devices or systems without express written approval by *NextGen*.
8. *NextGen* requires that customers first obtain an RMA (Returned Merchandise Authorization) number prior to returning any products. Returns must be made within 30 days of the date of invoice, be in the original packaging, unused and like-new condition. At the time of quoting or purchasing, a product may say that it is Non-Cancelable/ Non-Returnable (NCNR). These products are not returnable and not refundable.