



SPECIFICATION SHEET

SPECIFICATION SHEET NO.	R0608- MMBTA42S200S1D	
DATE	June 8, 2024	
REVISION	A2	Updated With Most Recent Data
DESCRIPTION AND MAIN PARAMETRICS	<p>SMD Plastic-Encapsulate Transistors, 3 Pads, Case SOT-23</p> <p>MMBT Series, Transistor Type NPN</p> <p>hFE Rank Range 60~200</p> <p>Collector-Base Voltage 300V Max. Collector Current 0.3A Max.</p> <p>Operating Temp. Range -55°C ~+150°C</p> <p>Package in Tape/Reel, 3000pcs/Reel</p> <p>RoHS III/REACH Compliant and Halogen Free (HF)</p>	
CUSTOMER		
CUSTOMER PART NO.		
CROSS REF. PART NO.		
ORIGINAL MFG/PART NO.	MDD Diodes/MMBTA42	
PART CODE	MMBTA42S200S1D	

VENDOR APPROVE			
Issued/Checked/Approved			
DATE: June 8, 2024			

CUSTOMER APPROVE	
DATE:	

SMD TRANSISTORS MMBT SERIES CASE SOT-23

MAIN FEATURE

- Epoxy Meets UL-94 V-0 Flammability Rating
- Epitaxial Planar Die Construction
- High Breakdown Voltage
- Low Collector-emitter Saturation Voltage
- Complementary PNP Type Available (Part Code: MMBTA92S200S2D)
- Surface Mount Package Ideally Suited for Automatic Insertion
- REACH/RoHS III Complaint and Halogen Free
- Cross Main Competitor Parts in Market



APPLICATION

- For SMD application

ELECTRICAL CHARACTERISTICS

- See Page 4~ Page 5

HOW TO ORDER

- Please Follow Up Part Code Guide And Indicate Pat Code When You Order Or RFQ For Custom Specification

PART CODE GUIDE

RFQ
Request For Quotation

CODE	NAME	KEY SPECIFICATION OPTION
MMBT	Product Series Code	SMD Plastic-Encapsulate Transistors MMBT series
A42	Specification Code	For Original Part Number MMBTA42
S2	Case Code	S2: Case SOT-23
00S	Internal Control Code	Custom letter A~Z, a-z or Digits (0-9)
1D	Marking Code	Custom letter A~Z, a-z or Digits (0-9)

SMD TRANSISTORS MMBT SERIES CASE SOT-23

DIMENSION (Unit: Inch/mm)

Image for reference

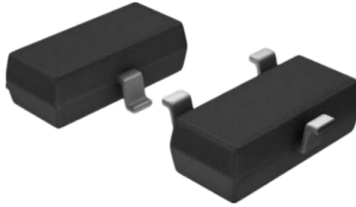

Marking:

1D

Pin Function

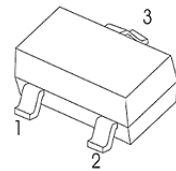

1. Base
2. Emitter
3. Collector

SOT-23

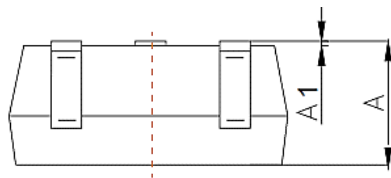
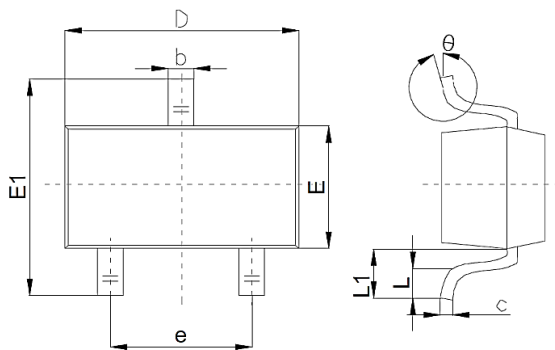

Symbol	Value (mm)		
	Min.	Typ.	Max.
A	0.9		1.4
A1			0.10
b	0.30		0.50
c	0.08		0.20
D	2.80	2.90	3.10
E	1.20		1.60
E1	2.25		2.80
e	1.8	1.9	2.00
L	0.10		0.50
L1	0.40		
θ	0°		10°

Recommend Pad Layout

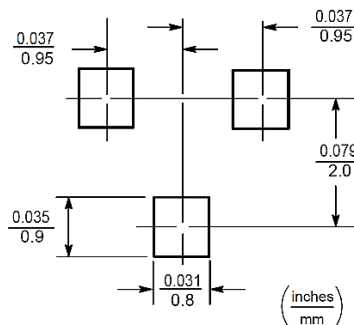

SMD TRANSISTORS MMBT SERIES CASE SOT-23

MAXIMUM RATINGS - @ 25 °C

PARAMETER	SYMBOLS	VALUE	UNITS
Collector-Base Voltage	V _{CB0}	300	Volts
Collector-Emitter Voltage	V _{CE0}	300	Volts
Emitter-Base Voltage	V _{EB0}	5	Volts
Collector Current -Continuous	I _C	0.3	A
Collector Power Dissipation	P _C	0.3	W
Thermal Resistance From Junction To Ambient	R _{θJA}	350	°C/W
Junction Temperature	T _J	+150	°C
Storage Temperature Range	T _{STG}	-55 ~ +150	°C

SMD TRANSISTORS MMBT SERIES CASE SOT-23
ELECTRICAL CHARACTERISTICS- @ 25 °C

PARAMETER	SYMBOLS	VALUE			UNIT	TEST CONDITION
		MIN.	TYP.	MAX.		
Collector-base Breakdown Voltage	$V_{(BR)CBO}$	300			V	$I_C = 100\mu A, I_E = 0$
Collector-emitter Breakdown Voltage	$V_{(BR)CEO}$	300			V	$I_C = 1mA, I_B = 0$
Emitter-base Breakdown Voltage	$V_{(BR)EBO}$	5			V	$I_E = 100\mu A, I_C = 0$
Collector Base Cut-off Current	I_{CBO}			0.25	μA	$V_{CB} = 200V, I_E = 0$
Emitter Base Cut-off Current	I_{EBO}			0.10	μA	$V_{EB} = 5V, I_C = 0$
DC Current Gain	$h_{FE(1)}$	60				$V_{CE} = 10V, I_C = 1mA$
	$h_{FE(2)}$	100		200		$V_{CE} = 10V, I_C = 10mA$
	$h_{FE(3)}$	65				$V_{CE} = 10V, I_C = 30mA$
Collector-emitter Saturation Voltage	$V_{CE(sat)}$			0.20	V	$I_C = 20mA, I_B = 2mA$
Base-emitter Saturation Voltage	$V_{BE(sat)}$			0.90	V	$I_C = 20mA, I_B = 2mA$
Transition Frequency	f_T	50			MHz	$V_{CE} = 20V, I_C = 10mA, f = 30MHz$

SMD TRANSISTORS MMBT SERIES CASE SOT-23

TYPICAL CHARACTERISTIC CURVES - For Reference Only

Fig.1 Static characteristics

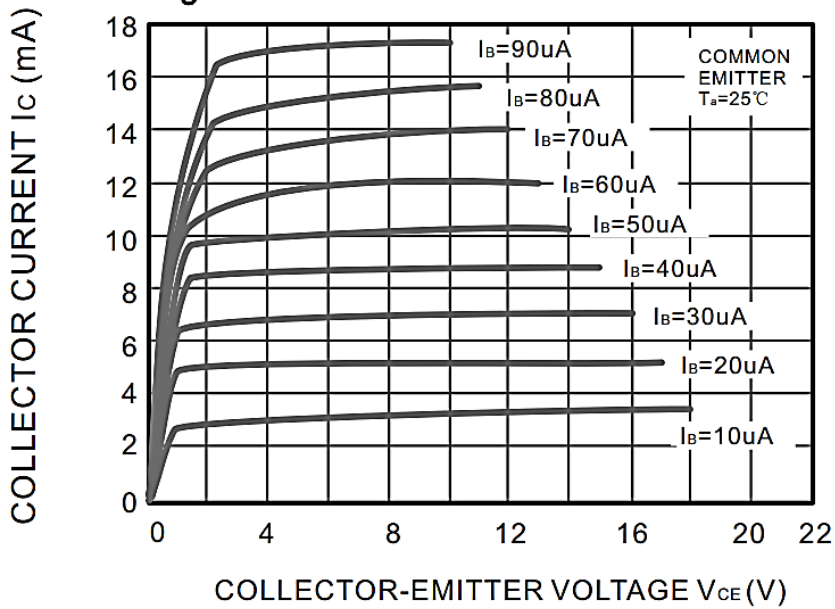
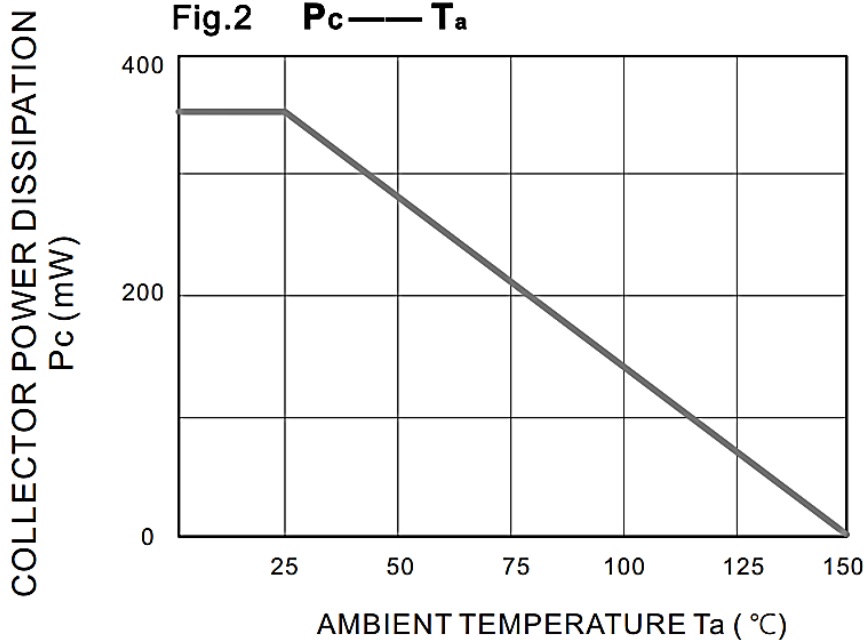
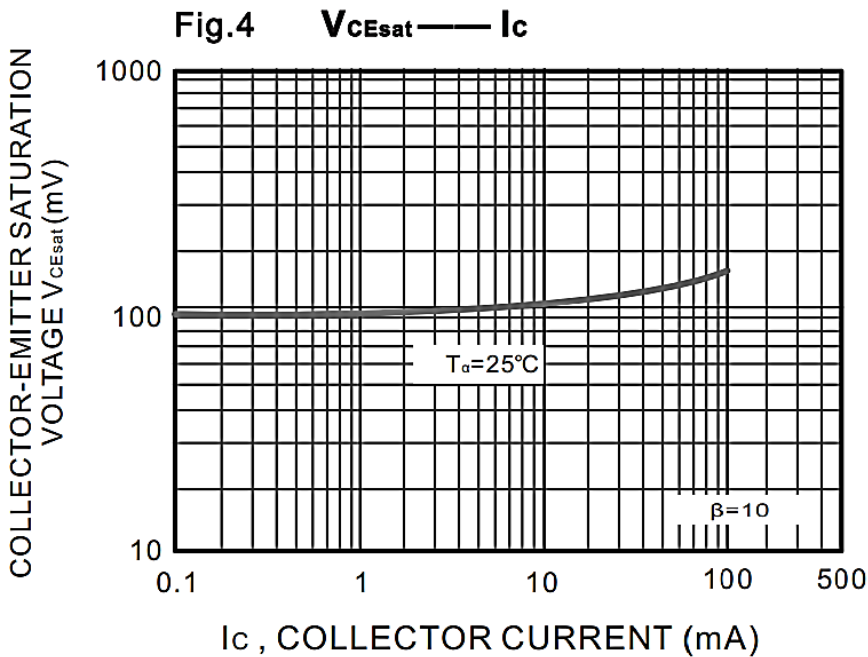
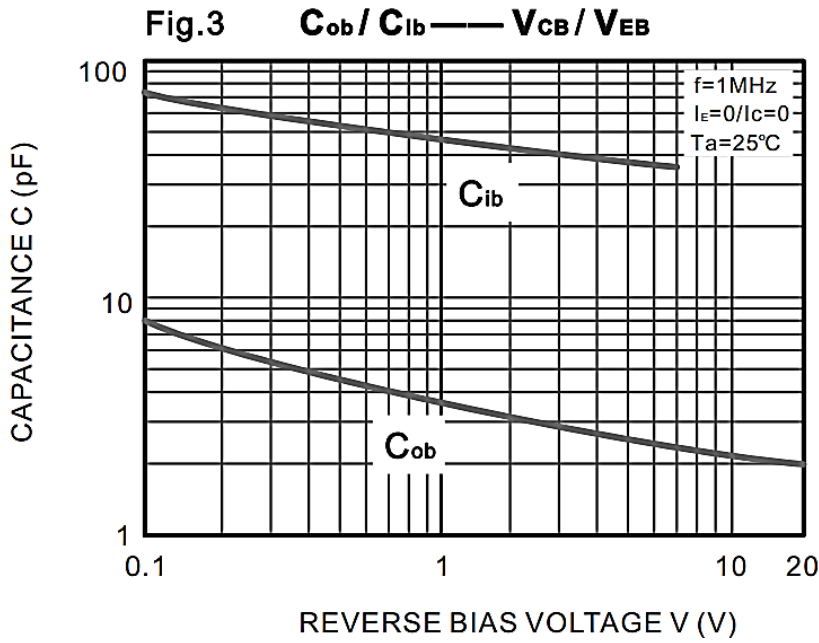

Fig.2 P_c — T_a



SMD TRANSISTORS MMBT SERIES CASE SOT-23

TYPICAL CHARACTERISTIC CURVES - For Reference Only



SMD TRANSISTORS MMBT SERIES CASE SOT-23

TYPICAL CHARACTERISTIC CURVES - For Reference Only

Fig.5 $h_{FE} - I_c$

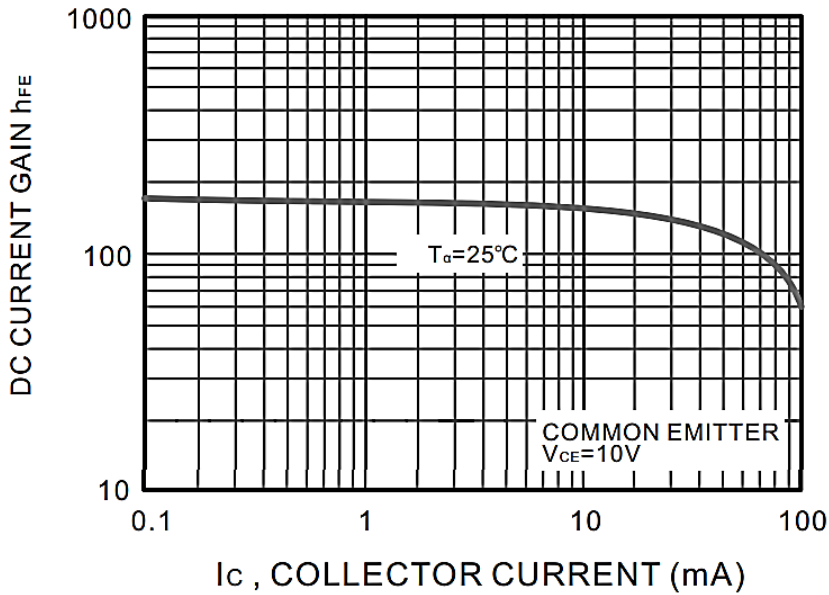
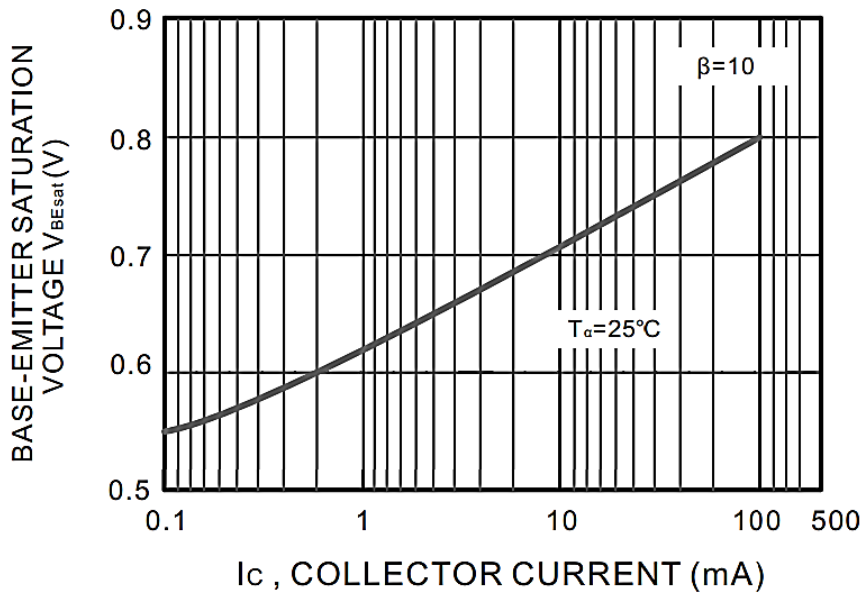
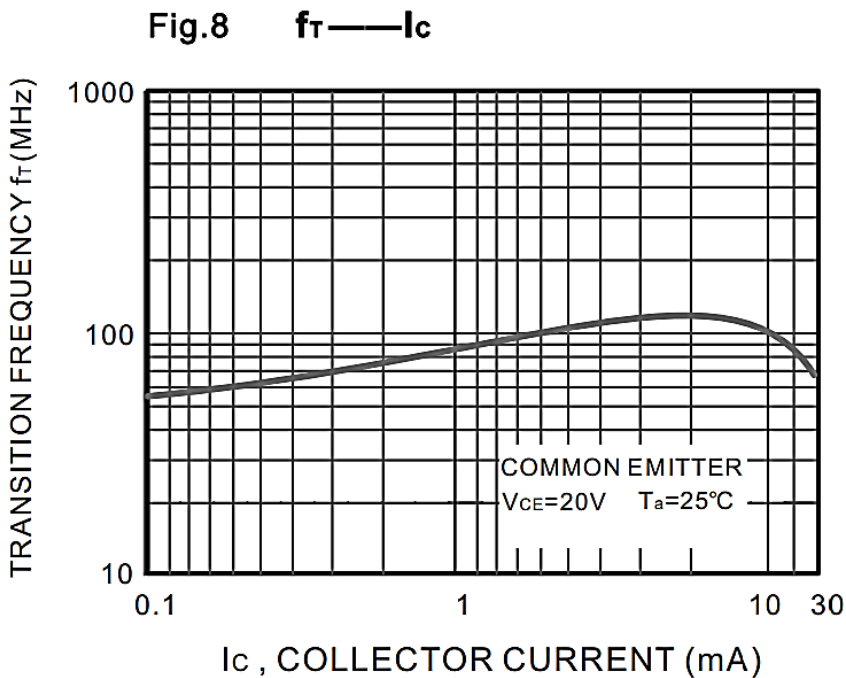
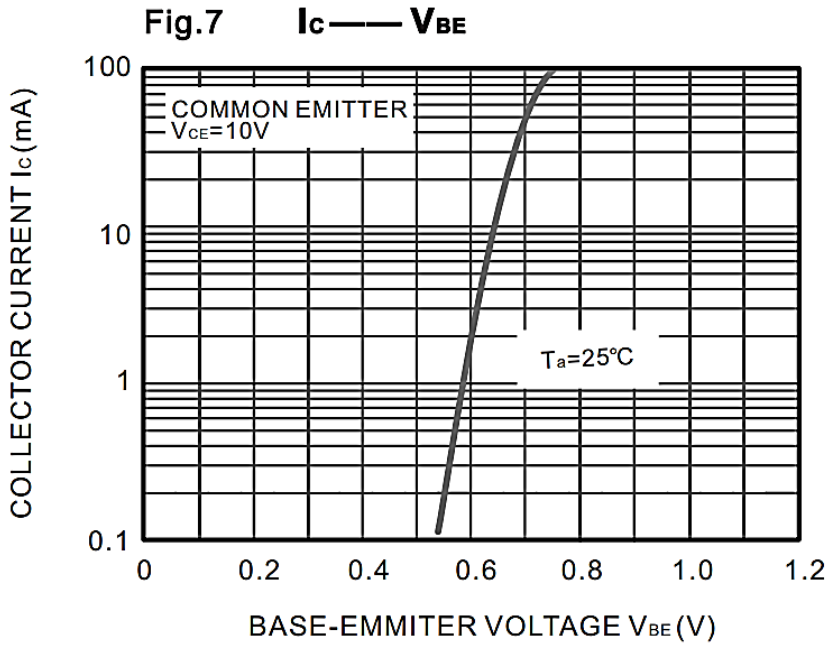

Fig.6 $V_{BEsat} - I_c$



SMD TRANSISTORS MMBT SERIES CASE SOT-23

TYPICAL CHARACTERISTIC CURVES - For Reference Only



SMD TRANSISTORS MMBT SERIES CASE SOT-23
RELIABILITY

Number	Experiment Items	Experiment Method And Conditions	Reference Documents
1	Solder Resistance Test	Test 260°C± 5°C for 10 ± 2 sec. Immerse body into solder 1/16" ± 1/32"	MIL-STD-750D METHOD-2031.2
2	Solderability Test	230°C ±5°C for 5 sec.	MIL-STD-750D METHOD-2026.1 0
3	Pull Test	1 kg in axial lead direction for 10 sec.	MIL-STD-750D METHOD-2036.4
4	Bend Test	0.5Kg Weight Applied To Each Lead, Bending Arcs 90 °C ± 5 °C For 3 Times	MIL-STD-750D METHOD-2036.4
5	High Temperature Reverse Bias Test	TA=100°C for 1000 Hours at VR=80% Rated VR	MIL-STD-750D METHOD-1038.4
6	Forward Operation Life Test	TA=25°C Rated Average Rectified Current	MIL-STD-750D METHOD-1027.3
7	Intermittent Operation Life Test	On state: 5 min with rated IRMS Power Off state: 5 min with Cool Forced Air. On and off for 1000 cycles.	MIL-STD-750D METHOD-1036.3
8	Pressure Cooker Test	15 PSIG, TA=121°C, 4 hours	MIL-S-19500 APPENOIXC
9	Temperature Cycling Test	-55°C~+125°C; 30 Minutes For Dwelled Time 5 minutes for transferred time. Total: 10 cycles.	MIL-STD-750D METHOD-1051.7
10	Thermal Shock Test	0°C for 5 minutes., 100°C for 5minutes, Total: 10 cycles	MIL-STD-750D METHOD-1056.7
11	Forward Surge Test	8.3ms Single Sale Sine-wave One Surge.	MIL-STD-750D METHOD-4066.4
12	Humidity Test	TA=65°C, RH=98% for 1000 hours.	MIL-STD-750D METHOD-1021.3
13	High Temperature Storage life Test	150°C for 1000 Hours	MIL-STD-750D METHOD-1031.5

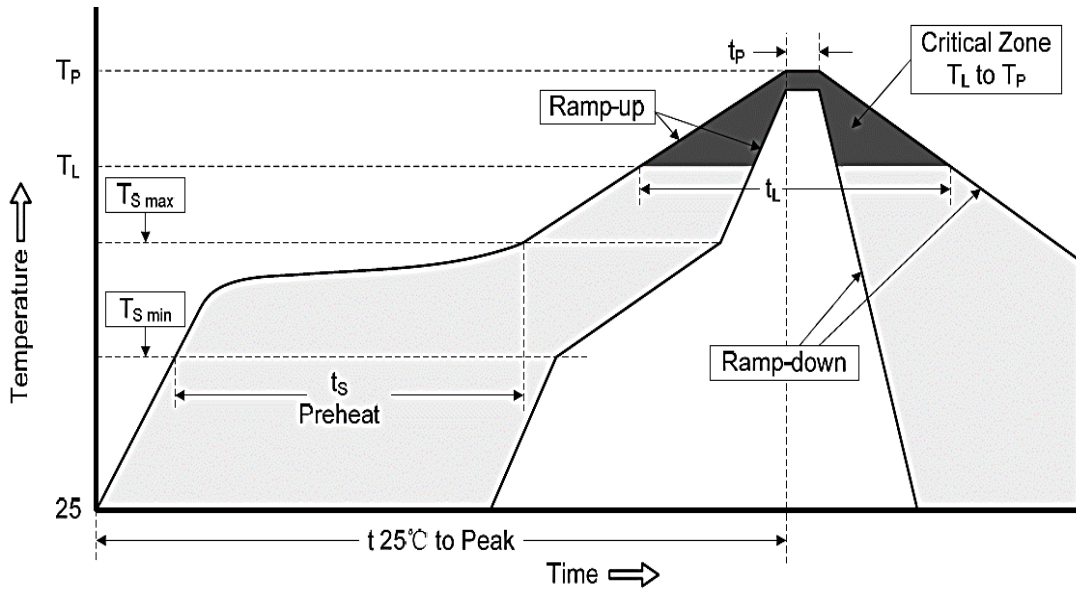
SMD TRANSISTORS MMBT SERIES CASE SOT-23
SUGGESTED REFLOW PROFILE - For Reference Only

PROFILE FEATURE		PB-FREE ASSEMBLY
Average Ramp-up Rate (Ts Max to Tp)		3°C/second Max
Preheat	Temperature Min (Ts Min.)	150°C
	Temperature Max (Ts Max.)	200°C
	Time (ts Min. to ts Max.)	60 ~ 180 seconds
Time maintained above	Temperature (Tl)	217°C
	Time (tl)	60 ~ 150 seconds
Peak/Classification Temperature (Tp)		260 °C
Time within 5°C of actual Peak Temperature (tp)		20 ~ 40 seconds
Ramp-down rate		6 °C /Second Max.
Time 25 °C to Peak Temperature		8 minutes Max.
Suggest reflow times		3 Times Max.

SMD TRANSISTORS MMBT SERIES CASE SOT-23
TAPE/REEL - Unit: mm

All Devices are packed in accordance with EIA standard RS-481-A and specifications.

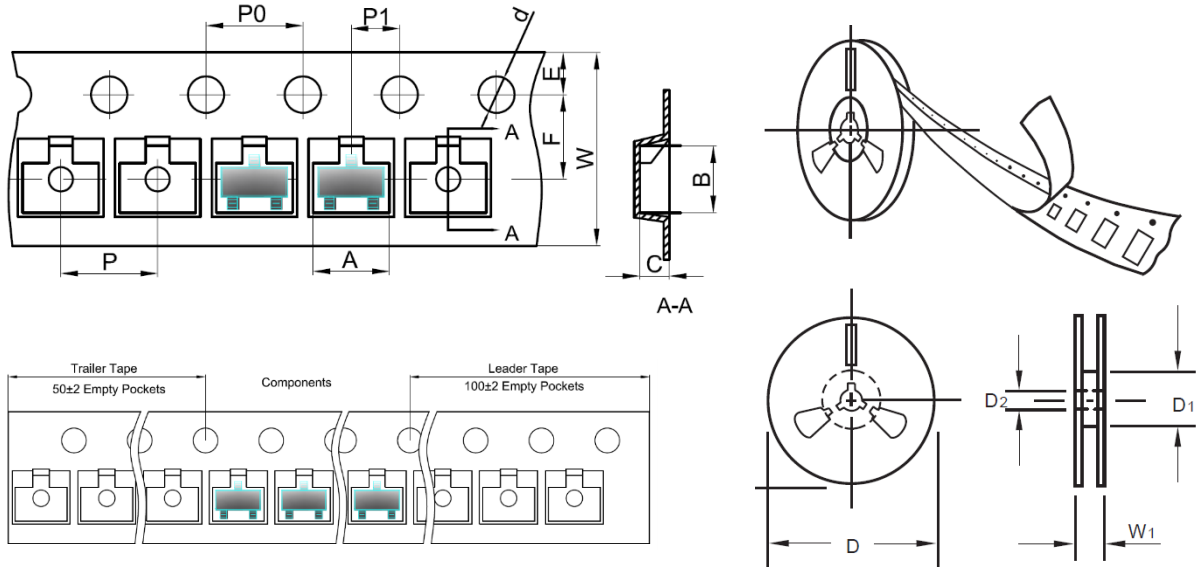

ITEM	SYMBOL	TOLERANCE	SOT-23
Carrier width	A	0.1	3.15
Carrier Length	B	0.1	2.77
Carrier Depth	C	0.1	1.22
Sprocket hole	d	0.05	1.55
7" Reel outside diameter	D	2.0	178.00
7" Reel inner diameter	D1	Min.	54.4
Feed hole diameter	D2	0.5	13.00
Sprocket hole position	E	0.1	1.75
Punch hole position	F	0.1	3.50
Punch hole pitch	P	0.1	4.00
Sprocket hole pitch	P0	0.1	4.00
Embossment center	P1	0.1	2.00
Overall tape thickness	T	0.1	0.25
Tape width	W	0.3	8.00
Reel width	W1	1.0	19.50
MPQ/Reel	3000pcs/Reel		

SMD TRANSISTORS MMBT SERIES CASE SOT-23

IMPORTANT NOTES AND DISCLAIMER

1. **ROHS COMPLIANCE:** The levels of RoHS restricted materials in this product are below the maximum concentration values (also referred to as the threshold limits) permitted for such substances, or are used in an exempted application, in accordance with EU RoHS Directive (EU) 2015/863 EC (RoHS3). RoHS Test Report for this product can be obtained at Download Center.
2. **REACH COMPLIANCE:** REACH substances of high concern (SVHCs) information is available for this product. Since the European Chemical Agency (ECHA) has published notice of their intent to frequently revise the SVHC listing for the foreseeable future, REACH Test Report for this product can be obtained at Download Center.
3. All Product parametric performance is indicated in the Electrical Characteristics for the listed herein test conditions, unless otherwise noted. Product performance may not be indicated by the Electrical Characteristics if operated under different conditions.
4. NextGen Component, Inc (*NextGen*) reserves the right to make changes to this document and its products and specifications at any time without notice. Customers should obtain and confirm the latest product information and specifications before final design, purchase or use.
5. *NextGen* makes no warranty, representation or guarantee regarding the suitability of its products for any particular purpose, not does *NextGen* assume any liability for application assistance or customer product design.
6. *NextGen* does not warrant or accept any liability with products which are purchased or used for any unintended or unauthorized application. No license is granted by implication or otherwise under any intellectual property rights of NextGen.
7. *NextGen* products are not authorized for use as critical components in life support devices or systems without express written approval by *NextGen*.
8. *NextGen* requires that customers first obtain an RMA (Returned Merchandise Authorization) number prior to returning any products. Returns must be made within 30 days of the date of invoice, be in the original packaging, unused and like-new condition. At the time of quoting or purchasing, a product may say that it is Non-Cancelable/ Non-Returnable (NCNR). These products are not returnable and not refundable.