

SPECIFICATION SHEET

SPECIFICATION SHEET NO.	R0610- S8550S2000S2TY	
DATE	June 10, 2024	
REVISION	A2	Updated With Most Recent Data
DESCRIPTION AND MAIN PARAMETRICS	<p>SMD Plastic-Encapsulate Transistors, 3 Pads, Case SOT-23</p> <p>S8 Series, Transistor Type PNP</p> <p>hFE Rank Range 120~400</p> <p>Collector-Base Voltage -40V Max. Collector Current -0.5A Max.</p> <p>Operating Temp. Range -55°C ~+150°C</p> <p>Package in Tape/Reel, 3000pcs/Reel</p> <p>RoHS III/REACH Compliant and Halogen Free (HF)</p>	
CUSTOMER		
CUSTOMER PART NO.		
CROSS REF. PART NO.		
ORIGINAL MFG/PART NO.	MDD Diodes/S8550	
PART CODE	S8550S2000S2TY	

VENDOR APPROVE

Issued/Checked/Approved



DATE: June 10, 2024

CUSTOMER APPROVE

DATE:

SMD TRANSISTORS S8 SERIES CASE SOT-23

MAIN FEATURE

- Epoxy Meets UL-94 V-0 Flammability Rating
- Collector Current: $I_c = -0.5A$
- Complementary NPN Type Available (Part Code: S8050S2000SJ3Y)
- Surface Mount Package Ideally Suited for Automatic Insertion
- REACH/RoHS III Complaint and Halogen Free
- Cross Main Competitor Parts in Market



APPLICATION

- For SMD application

ELECTRICAL CHARACTERISTICS

- See Page 4~ Page 5

HOW TO ORDER

- Please Follow Up Part Code Guide And Indicate Pat Code When You Order Or RFQ For Custom Specification

PART CODE GUIDE

RFQ
Request For Quotation

CODE	NAME	KEY SPECIFICATION OPTION
S8	Product Series Code	SMD Plastic-Encapsulate Transistors S8 series
550	Specification Code	For Original Part Number S8550
S2	Case Code	S2: Case SOT-23
000S	Internal Control Code	Custom letter A~Z, a-z or Digits (0-9)
2TY	Marking Code	Custom letter A~Z, a-z or Digits (0-9)

SMD TRANSISTORS S8 SERIES CASE SOT-23

DIMENSION (Unit: Inch/mm)

Image for reference

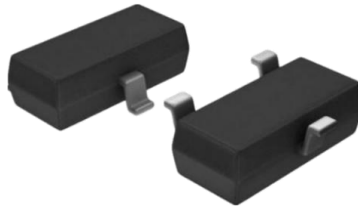

Marking:

2TY

Pin Function

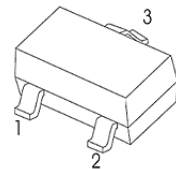

- 1. Base
- 2. Emitter
- 3. Collector

SOT-23

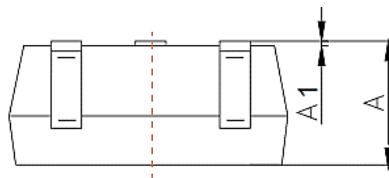
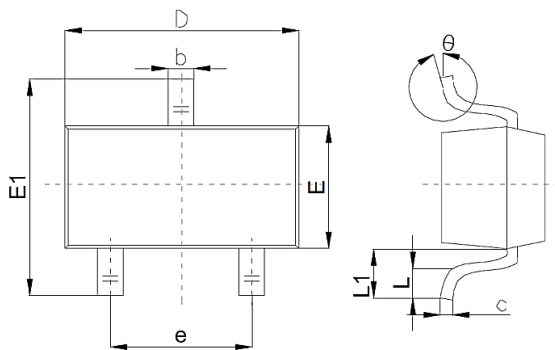

Recommend Pad Layout

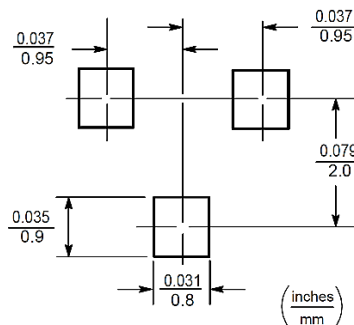

Symbol	Value (mm)		
	Min.	Typ.	Max.
A	0.9		1.4
A1			0.10
b	0.30		0.50
c	0.08		0.20
D	2.80	2.90	3.10
E	1.20		1.60
E1	2.25		2.80
e	1.8	1.9	2.00
L	0.10		0.50
L1	0.40		
θ	0°		10°

SMD TRANSISTORS S8 SERIES CASE SOT-23
CLASSIFICATION OF hFE

PART CODE	RANK CODE	RANK RANG	MARKING
S8550S2000S2TY	L	120~ 200	2TY
	H	200~ 350	
	J	300~400	

MAXIMUM RATINGS - @ 25 °C

PARAMETER	SYMBOLS	VALUE	UNITS
Collector-Base Voltage	VCBO	-40	Volts
Collector-Emitter Voltage	VCEO	-25	Volts
Emitter-Base Voltage	VEBO	-5	Volts
Collector Current -Continuous	IC	-0.5	A
Collector Power Dissipation	Pc	0.3	W
Junction Temperature	TJ	+150	°C
Storage Temperature Range	TSTG	-55 ~ +150	°C

SMD TRANSISTORS S8 SERIES CASE SOT-23
ELECTRICAL CHARACTERISTICS- @ 25 °C

PARAMETER	SYMBOLS	VALUE			UNIT	TEST CONDITION
		MIN.	TYP.	MAX.		
Collector-base Breakdown Voltage	V(BR)CBO	-40			V	I _c = -100μA, I _E =0
Collector-emitter Breakdown Voltage	V(BR)CEO	-25			V	I _c = -1mA, I _B =0
Emitter-base Breakdown Voltage	V(BR)EBO	-5			V	I _E = -100μA, I _C =0
Collector Base Cut-off Current	I _{CBO}			-0.1	μA	V _{CB} = -40V, I _E =0
Collector Cut-off Current	I _{CEO}			-0.1	μA	V _{CB} = -20V, I _E =0
Emitter Base Cut-off Current	I _{EBO}			-0.1	μA	V _{EB} = -3V, I _C =0
DC Current Gain	h _{FE} (1)	120		400		V _{CE} =-1V, I _C =-50mA
Collector-emitter Saturation Voltage	V _{CE(sat)}			-0.6	V	I _C =-500mA, I _B =-50mA
Base-emitter Saturation Voltage	V _{BE(sat)}			-1.2	V	I _C =-500mA, I _B =-50mA
Transition Frequency	f _T	150			MHz	V _{CE} =-6V, I _C = -20mA, f=30MHz

SMD TRANSISTORS S8 SERIES CASE SOT-23

TYPICAL CHARACTERISTIC CURVES - For Reference Only

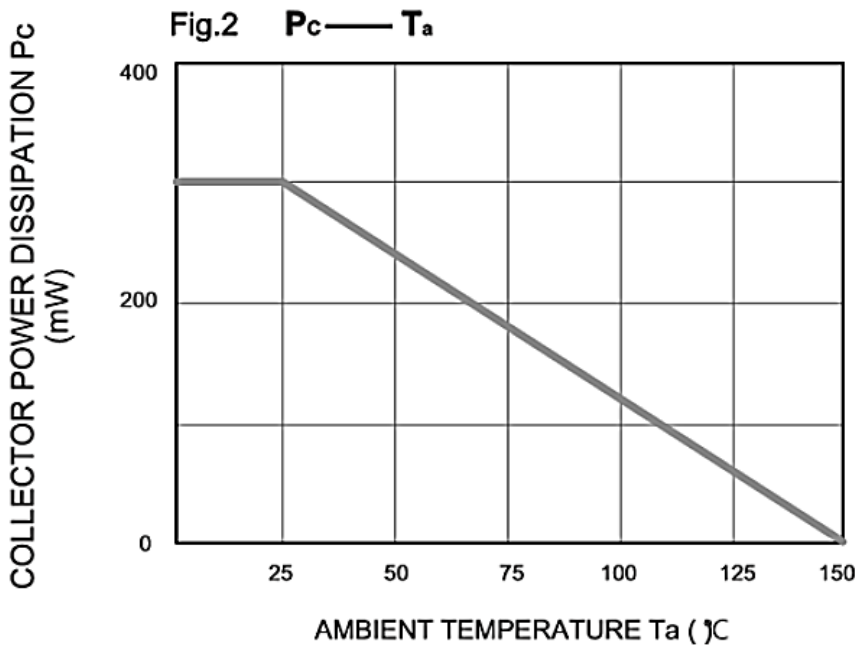
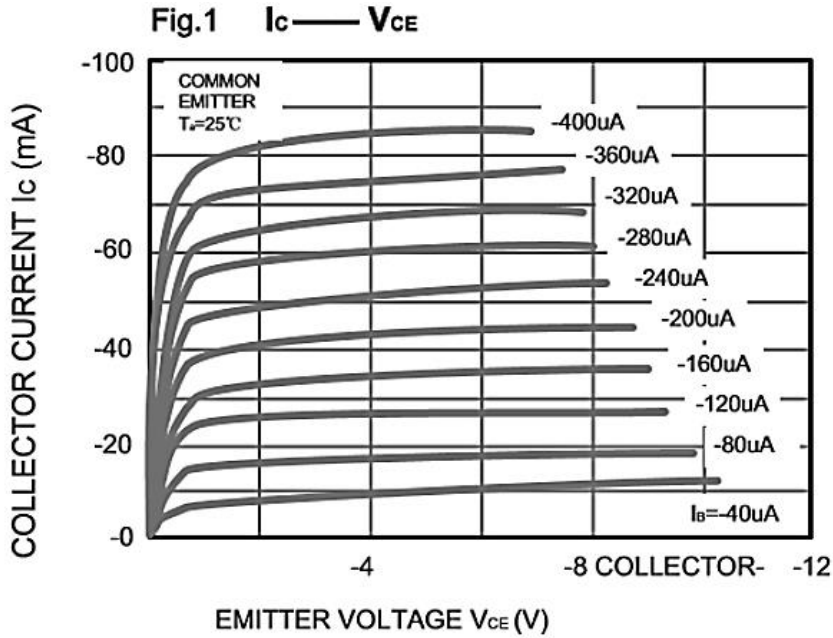

SMD TRANSISTORS S8 SERIES CASE SOT-23

TYPICAL CHARACTERISTIC CURVES - For Reference Only

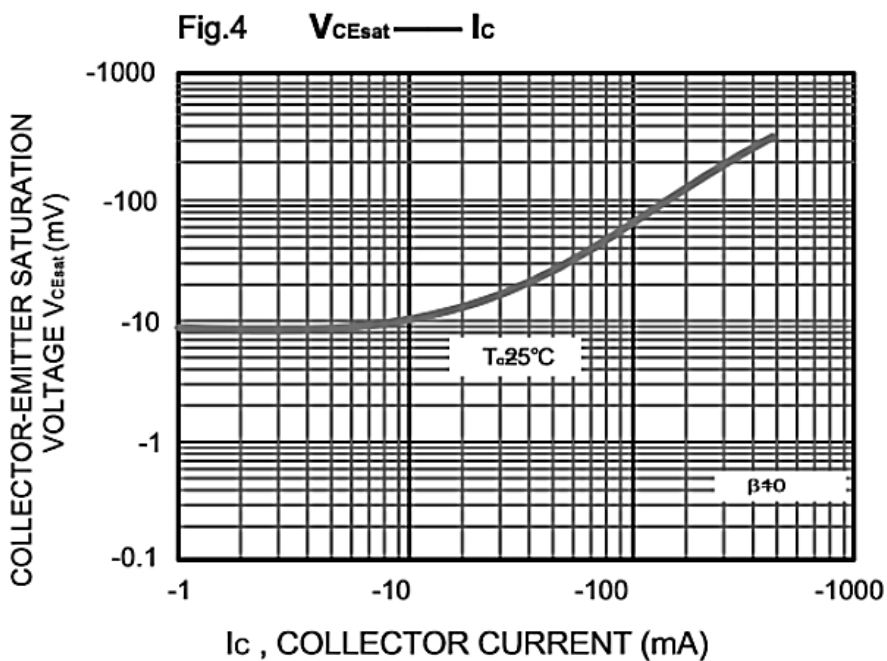
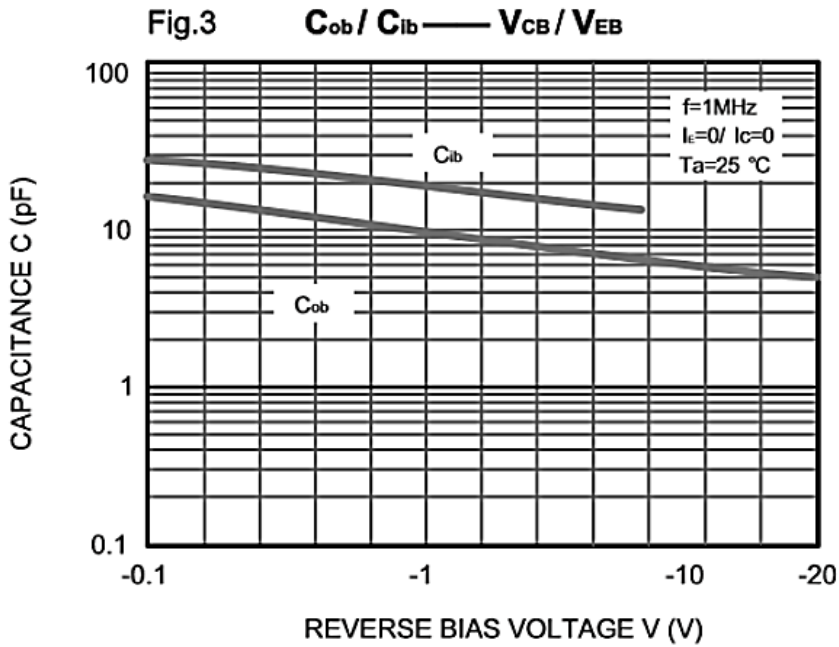

SMD TRANSISTORS S8 SERIES CASE SOT-23

TYPICAL CHARACTERISTIC CURVES - For Reference Only

Fig.5 $h_{FE} - I_c$

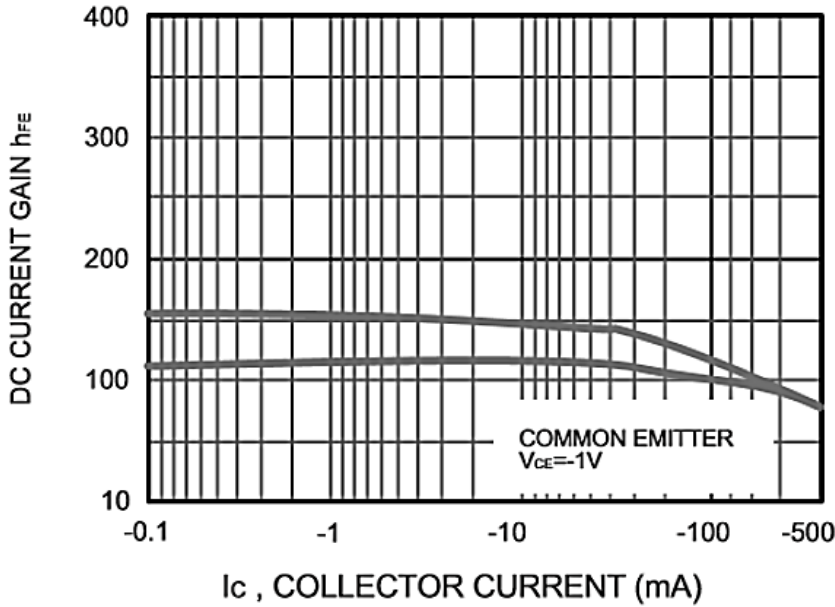
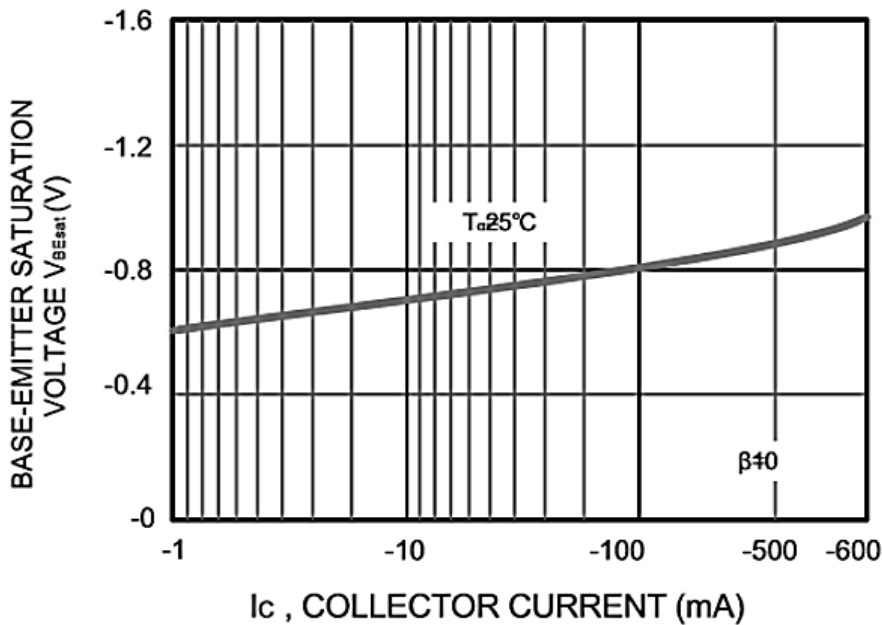
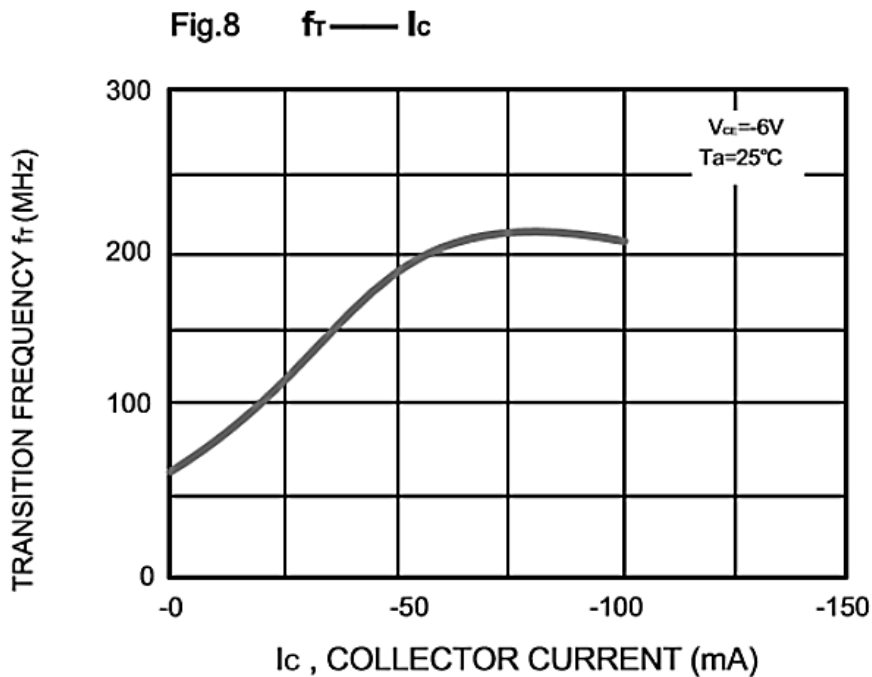
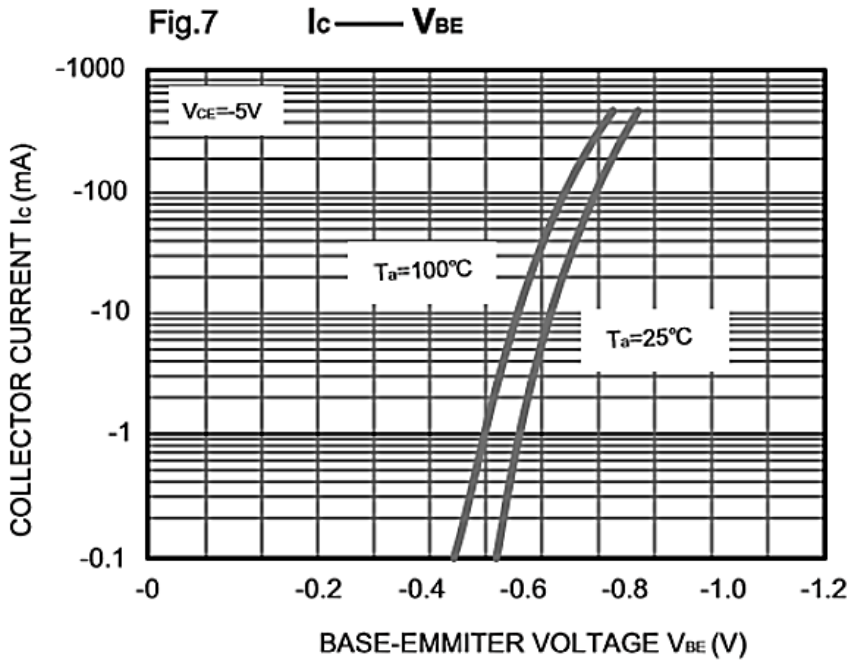

Fig.6 $V_{BEsat} - I_c$



SMD TRANSISTORS S8 SERIES CASE SOT-23

TYPICAL CHARACTERISTIC CURVES - For Reference Only



SMD TRANSISTORS S8 SERIES CASE SOT-23
RELIABILITY

Number	Experiment Items	Experiment Method And Conditions	Reference Documents
1	Solder Resistance Test	Test 260°C± 5°C for 10 ± 2 sec. Immerse body into solder 1/16" ± 1/32"	MIL-STD-750D METHOD-2031.2
2	Solderability Test	230°C ±5°C for 5 sec.	MIL-STD-750D METHOD-2026.1 0
3	Pull Test	1 kg in axial lead direction for 10 sec.	MIL-STD-750D METHOD-2036.4
4	Bend Test	0.5Kg Weight Applied To Each Lead, Bending Arcs 90 °C ± 5 °C For 3 Times	MIL-STD-750D METHOD-2036.4
5	High Temperature Reverse Bias Test	TA=100°C for 1000 Hours at VR=80% Rated VR	MIL-STD-750D METHOD-1038.4
6	Forward Operation Life Test	TA=25°C Rated Average Rectified Current	MIL-STD-750D METHOD-1027.3
7	Intermittent Operation Life Test	On state: 5 min with rated IRMS Power Off state: 5 min with Cool Forced Air. On and off for 1000 cycles.	MIL-STD-750D METHOD-1036.3
8	Pressure Cooker Test	15 PSIG, TA=121°C, 4 hours	MIL-S-19500 APPENOIXC
9	Temperature Cycling Test	-55°C~+125°C; 30 Minutes For Dwelled Time 5 minutes for transferred time. Total: 10 cycles.	MIL-STD-750D METHOD-1051.7
10	Thermal Shock Test	0°C for 5 minutes., 100°C for 5minutes, Total: 10 cycles	MIL-STD-750D METHOD-1056.7
11	Forward Surge Test	8.3ms Single Sale Sine-wave One Surge.	MIL-STD-750D METHOD-4066.4
12	Humidity Test	TA=65°C, RH=98% for 1000 hours.	MIL-STD-750D METHOD-1021.3
13	High Temperature Storage life Test	150°C for 1000 Hours	MIL-STD-750D METHOD-1031.5

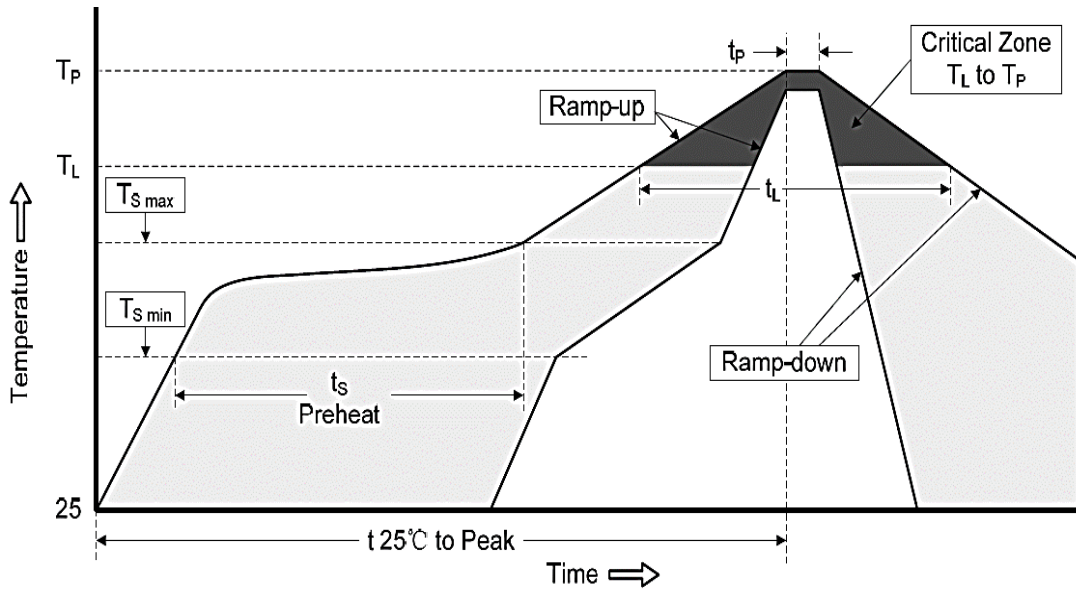
SMD TRANSISTORS S8 SERIES CASE SOT-23
SUGGESTED REFLOW PROFILE - For Reference Only

PROFILE FEATURE		PB-FREE ASSEMBLY
Average Ramp-up Rate (Ts Max to Tp)		3°C/second Max
Preheat	Temperature Min (Ts Min.)	150°C
	Temperature Max (Ts Max.)	200°C
	Time (ts Min. to ts Max.)	60 ~ 180 seconds
Time maintained above	Temperature (Tl)	217°C
	Time (tl)	60 ~ 150 seconds
Peak/Classification Temperature (Tp)		260 °C
Time within 5°C of actual Peak Temperature (tp)		20 ~ 40 seconds
Ramp-down rate		6 °C /Second Max.
Time 25 °C to Peak Temperature		8 minutes Max.
Suggest reflow times		3 Times Max.

SMD TRANSISTORS S8 SERIES CASE SOT-23
TAPE/REEL - Unit: mm

All Devices are packed in accordance with EIA standard RS-481-A and specifications. SOT-23 parts are shipped in tape. The carrier tape is made from a dissipative (carbon filled) polycarbonate resin. The cover tape is a multilayer film (Heat Activated Adhesive in nature) primarily composed of polyester film, adhesive layer, sealant, and anti-static sprayed agent. These reeled parts in standard option are shipped with 3,000 units per 7" or 17.8cm diameter reel. The reels are clear in color and is made of polystyrene plastic (anti-static coated).

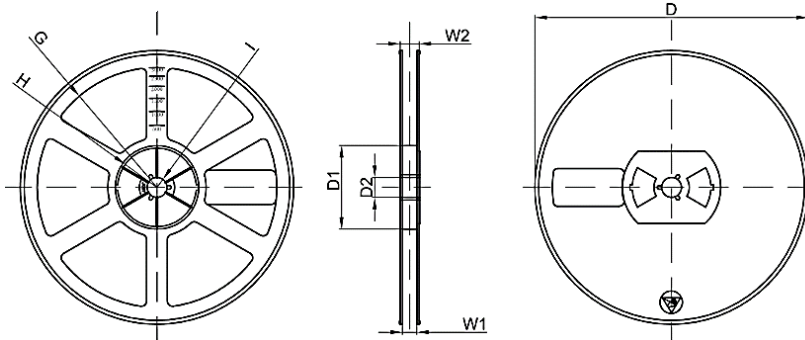
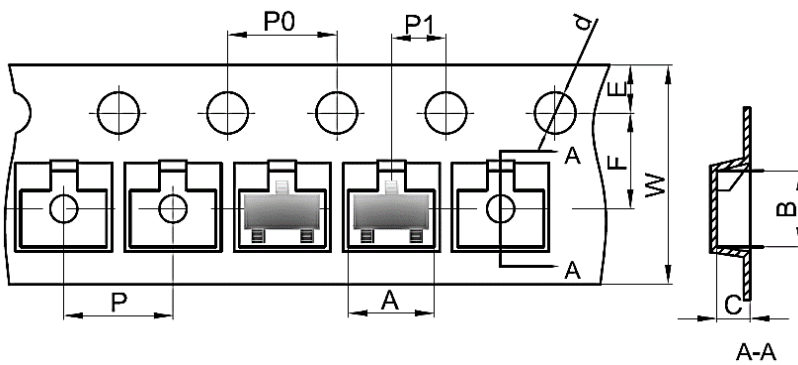

Symbol	Dimension (mm)
A	3.15±0.1
B	2.77±0.1
C	1.22±0.1
d	φ1.50±0.1
E	1.75±0.1
F	3.50±0.1
P0	4.00±0.1
P	4.00±0.1
P1	2.00±0.1
W	8.00±0.1
D	φ178±2
D1	54.4±1
D2	13.0±1
G	R78±1
H	R25.6±1
I	R6.5±1
W1	9.5±1
W2	12.3±1

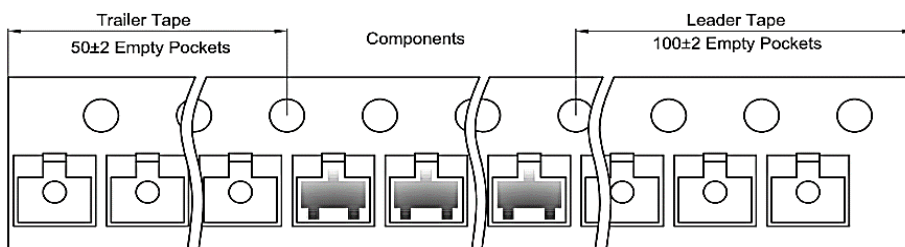
TAPE LEADER AND TRAILER

SMD TRANSISTORS S8 SERIES CASE SOT-23

IMPORTANT NOTES AND DISCLAIMER

1. **ROHS COMPLIANCE:** The levels of RoHS restricted materials in this product are below the maximum concentration values (also referred to as the threshold limits) permitted for such substances, or are used in an exempted application, in accordance with EU RoHS Directive (EU) 2015/863 EC (RoHS3). RoHS Test Report for this product can be obtained at Download Center.
2. **REACH COMPLIANCE:** REACH substances of high concern (SVHCs) information is available for this product. Since the European Chemical Agency (ECHA) has published notice of their intent to frequently revise the SVHC listing for the foreseeable future, REACH Test Report for this product can be obtained at Download Center.
3. All Product parametric performance is indicated in the Electrical Characteristics for the listed herein test conditions, unless otherwise noted. Product performance may not be indicated by the Electrical Characteristics if operated under different conditions.
4. NextGen Component, Inc (*NextGen*) reserves the right to make changes to this document and its products and specifications at any time without notice. Customers should obtain and confirm the latest product information and specifications before final design, purchase or use.
5. *NextGen* makes no warranty, representation or guarantee regarding the suitability of its products for any particular purpose, not does *NextGen* assume any liability for application assistance or customer product design.
6. *NextGen* does not warrant or accept any liability with products which are purchased or used for any unintended or unauthorized application. No license is granted by implication or otherwise under any intellectual property rights of NextGen.
7. *NextGen* products are not authorized for use as critical components in life support devices or systems without express written approval by *NextGen*.
8. *NextGen* requires that customers first obtain an RMA (Returned Merchandise Authorization) number prior to returning any products. Returns must be made within 30 days of the date of invoice, be in the original packaging, unused and like-new condition. At the time of quoting or purchasing, a product may say that it is Non-Cancelable/ Non-Returnable (NCNR). These products are not returnable and not refundable.