

SPECIFICATION SHEET

SPECIFICATION SHEET NO.	R0618- BC857AS2000S3E	
DATE	June 18, 2024	
REVISION	A0	Updated With Most Recent Data- Official First Release
DESCRIPTION AND MAIN PARAMETRICS	<p>SMD Plastic-Encapsulate Transistors, 3 Pads, Case SOT-23</p> <p>BC85 Series, Transistor Type PNP,</p> <p>hFE Rank Range (3E) 125~250</p> <p>Collector-Base Voltage -50V Max. Collector Current -0.1A Max.</p> <p>Operating Temp. Range -65°C ~+150°C</p> <p>Package in Tape/Reel, 3000pcs/Reel</p> <p>RoHS III/REACH Compliant and Halogen Free (HF)</p>	
CUSTOMER		
CUSTOMER PART NO.		
CROSS REF. PART NO.		
ORIGINAL MFG/PART NO.	MDD Diodes/BC857A-3E	
PART CODE	BC857AS2000S3E	

VENDOR APPROVE

Issued/Checked/Approved



DATE: June 18, 2024

CUSTOMER APPROVE

DATE:

SMD TRANSISTORS BC85 SERIES CASE SOT-23

MAIN FEATURE

- Low current.(max.100mA) and Low voltage.(max.65v)
- DC Current Gain: $h_{FE}=125\sim 800$ @ $V_{CE}=-5V$, $I_C=-2mA$
- Surface Mount Package Ideally Suited for Automatic Insertion
- REACH/RoHS III Complaint and Halogen Free
- Cross Main Competitor Parts in Market



APPLICATION

- For Switching and AF Amplifier Applications

ELECTRICAL CHARACTERISTICS

- See Page 4~ Page 6 For Different Part Code

HOW TO ORDER

- Please Follow Up Part Code Guide And Indicate Pat Code When You Order Or RFQ For Custom Specification

PART CODE GUIDE

[RFQ](#)
Request For Quotation

CODE	NAME	KEY SPECIFICATION OPTION
BC85	Product Series Code	SMD Plastic-Encapsulate Transistors BC85 series
7A	Specification Code	For Original Part Number BC857A-3E
S2	Case Code	S2: Case SOT-23
000S	Internal Control Code	Custom letter A~Z, a-z or Digits (0-9)
3E	Marking Code	Custom letter A~Z, a-z or Digits (0-9), For different Part Code, see Page 6

SMD TRANSISTORS BC85 SERIES CASE SOT-23

DIMENSION (Unit: Inch/mm)

Image for reference



Marking:

See Page 6 - Marking List

For different Part code

SOT-23

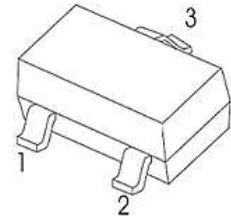
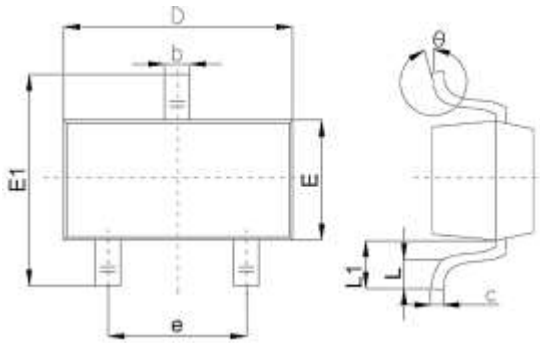

1. Base
2. Emitter
3. Collector

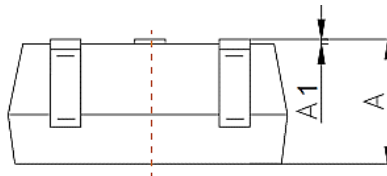

**Recommend
Pad Layout**

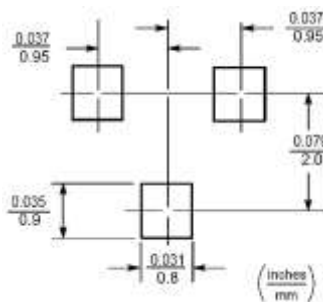

Symbol	Value (mm)		
	Min.	Typ.	Max.
A	0.9		1.4
A1			0.10
b	0.30		0.50
c	0.08		0.20
D	2.80	2.90	3.10
E	1.20		1.60
E1	2.25		2.80
e	1.8	1.9	2.00
L	0.10		0.50
L1	0.40		0.55
θ	0°		10°

SMD TRANSISTORS BC85 SERIES CASE SOT-23
MAXIMUM RATINGS - @ 25 °C

PARAMETER	SYMBOLS	VALUE	UNITS
Emitter-Base Voltage	VEBO	-5.0	V
Collector Current -Continuous	IC	-0.1	A
Collector Power Dissipation	PC	250	mW
Junction Temperature	TJ	+150	°C
Storage Temperature Range	T STG	-65 ~ +150	°C

MAXIMUM RATINGS - @ 25 °C

PART CODE	Collector-Base Voltage	Collector-Emitter Voltage
	VCBO	VCEO
	V	V
BC856AS2000S3A	-80	-65
BC856BS2000S3B	-80	-65
BC857AS2000S3E	-50	-45
BC857BS2000S3F	-50	-45
BC857CS2000S3G	-50	-45
BC858AS2000S3J	-30	-30
BC858BS2000S3K	-30	-30
BC858CS2000S3L	-30	-30

SMD TRANSISTORS BC85 SERIES CASE SOT-23
ELECTRICAL MAXIMUM RATINGS - @ 25 °C

PARAMETER	SYMBOLS	VALUE			UNIT	TEST CONDITION
		MIN.	TYP.	MAX		
Emitter-Base Breakdown Voltage	VEBO	-5.0			V	IE= -1μA, IC=0
Emitter Cut-off Current	IEBO			-0.1	μA	VEB=- 5V, IC=0
Collector-emitter Saturation Voltage	VCE(sat)			-0.5	V	IC=-100mA, IB=-5mA
Base-emitter Saturation Voltage	VBE(sat)			-1.1	V	IC=-100mA, IB=-5mA
Transition Frequency	f _T	100			MHz	VCE=-5V, IC=-10mA f=100MHz
Collector Output Capacitance	Cob			4.5	pF	VCB=-10V, f=1MHz

ELECTRICAL MAXIMUM RATINGS - @ 25 °C

PART CODE	Min. Collector-Base Breakdown Voltage	Min. Collector-Emitter Breakdown Voltage	DC Current Gain Range
	@ IC=-10μA, IE=0	@ IC=-10mA, IB=0	@VCE=-5V, IC=-2mA
	VCBO	VCEO	hFE
	V	V	
BC856AS2000S3A	-80	-65	125~250
BC856BS2000S3B	-80	-65	220~475
BC857AS2000S3E	-50	-45	125~250
BC857BS2000S3F	-50	-45	220~475
BC857CS2000S3G	-50	-45	420~800
BC858AS2000S3J	-30	-30	125~250
BC858BS2000S3K	-30	-30	220~475
BC858CS2000S3L	-30	-30	420~800

SMD TRANSISTORS BC85 SERIES CASE SOT-23
ELECTRICAL MAXIMUM RATINGS - @ 25 °C

PART CODE	Max. Collector Cut-off Current			Marking List
	V _{CB} =-70V I _E =0	V _{CB} =-45V I _E =0	V _{CB} =-25V I _E =0	
	I _{CBO}			
	μA			
BC856AS2000S3A	-0.1	-0.1	-0.1	3A
BC856BS2000S3B	-0.1	-0.1	-0.1	3B
BC857AS2000S3E	-0.1	-0.1	-0.1	3E
BC857BS2000S3F	-0.1	-0.1	-0.1	3F
BC857CS2000S3G	-0.1	-0.1	-0.1	3G
BC858AS2000S3J	-0.1	-0.1	-0.1	3J
BC858BS2000S3K	-0.1	-0.1	-0.1	3K
BC858CS2000S3L	-0.1	-0.1	-0.1	3L

SMD TRANSISTORS BC85 SERIES CASE SOT-23

TYPICAL CHARACTERISTIC CURVES - For Reference Only

Fig.1

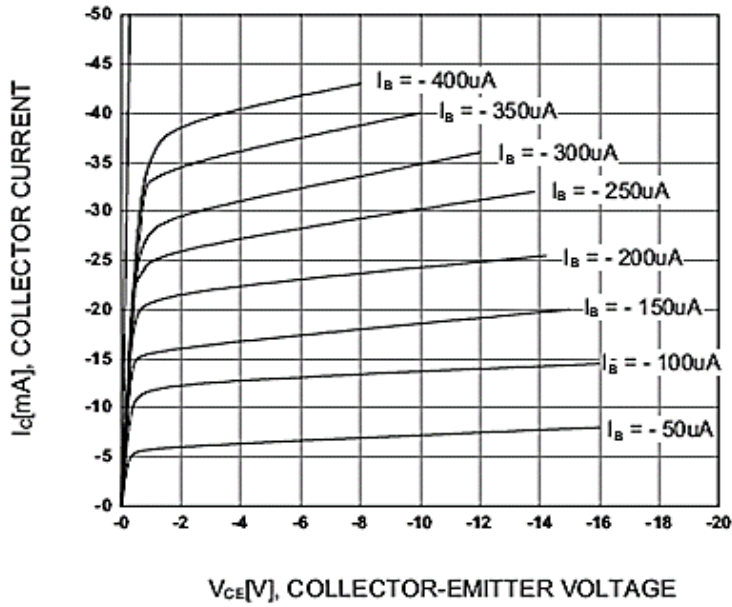
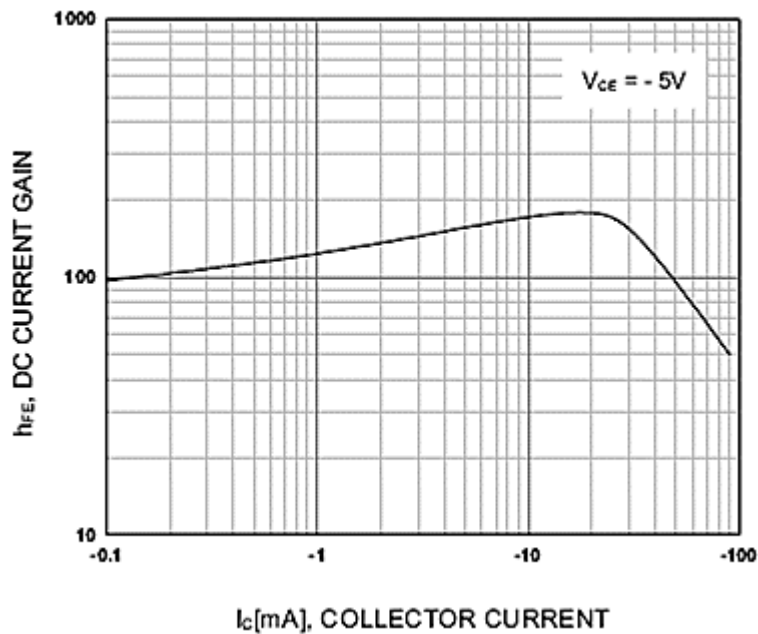

Fig.2



SMD TRANSISTORS BC85 SERIES CASE SOT-23

TYPICAL CHARACTERISTIC CURVES - For Reference Only

Fig.3

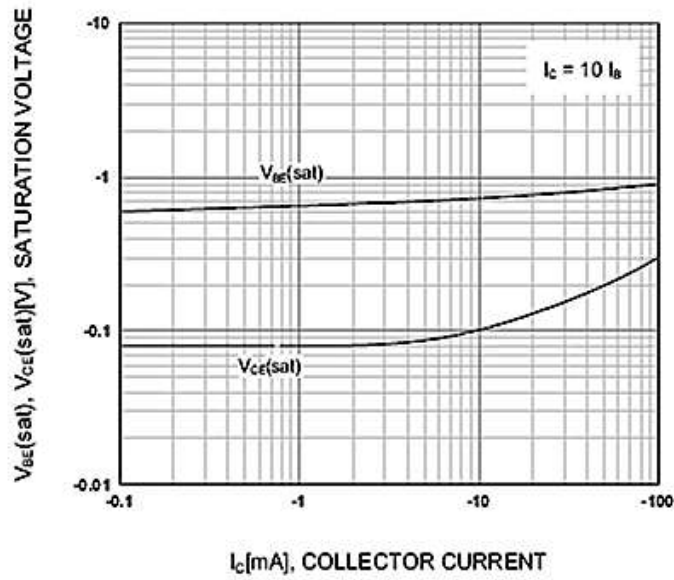
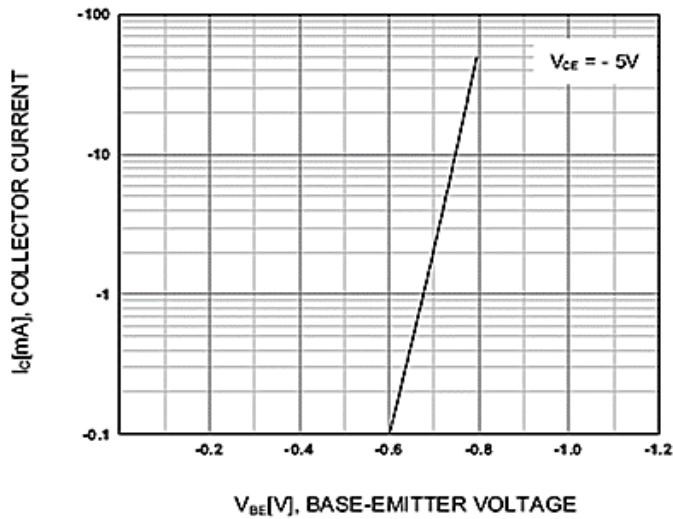

Fig.4



SMD TRANSISTORS BC85 SERIES CASE SOT-23

TYPICAL CHARACTERISTIC CURVES - For Reference Only

Fig.5

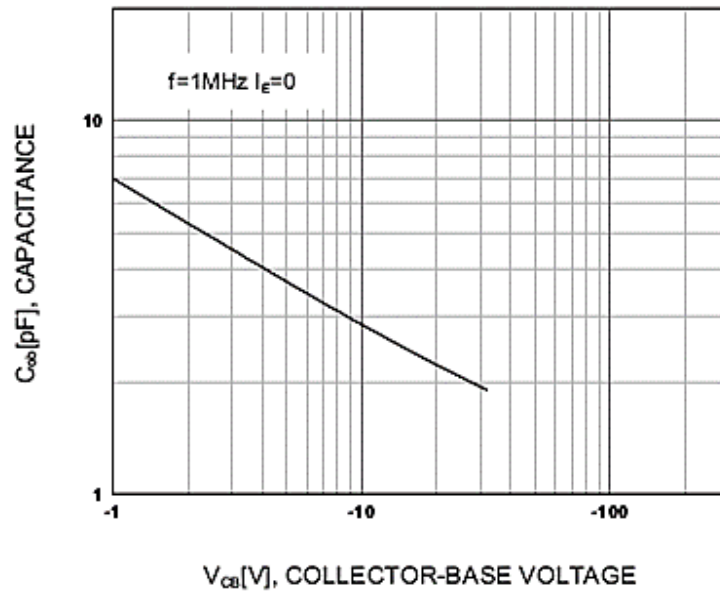
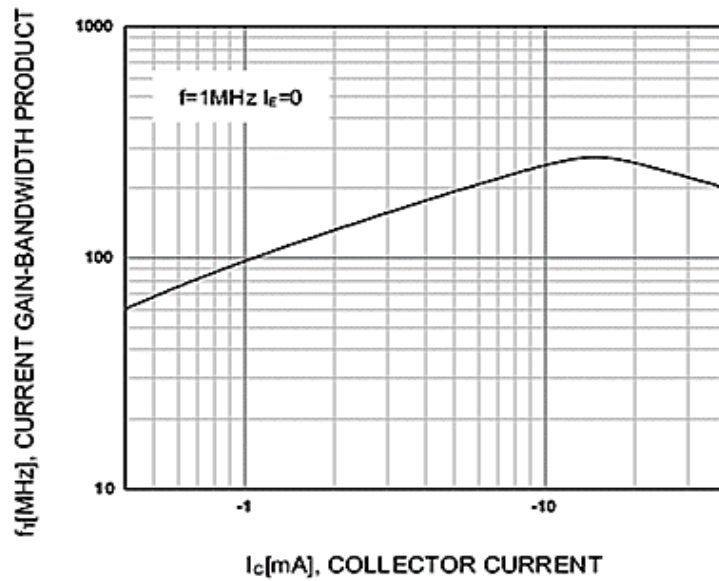
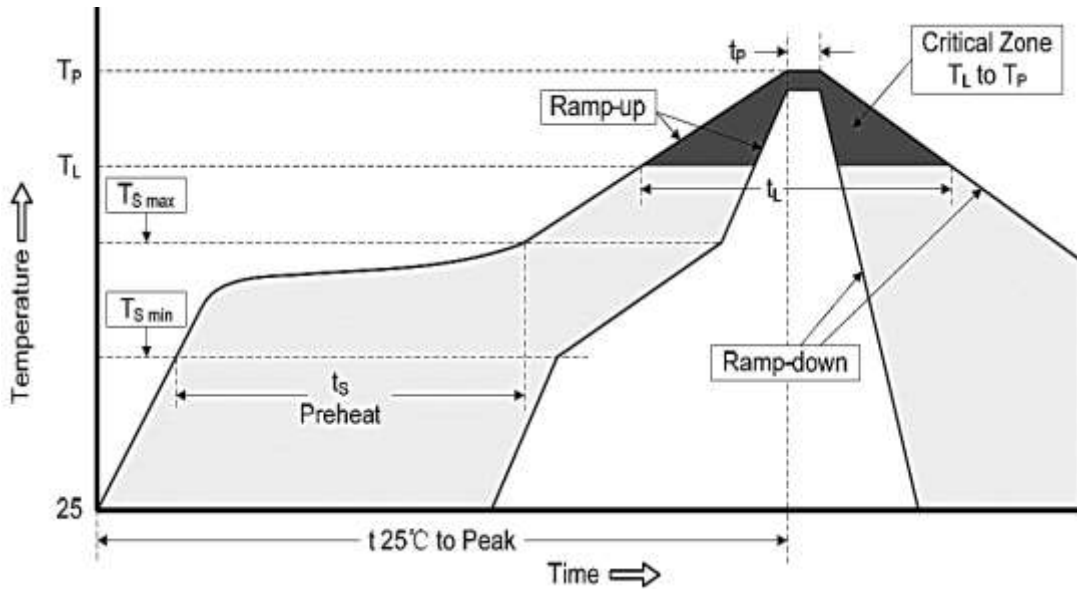

Fig.6



SMD TRANSISTORS BC85 SERIES CASE SOT-23
RELIABILITY

Number	Experiment Items	Experiment Method And Conditions	Reference Documents
1	Solder Resistance Test	Test 260°C± 5°C for 10 ± 2 sec. Immerse body into solder 1/16" ± 1/32"	MIL-STD-750D METHOD-2031.2
2	Solderability Test	230°C ±5°C for 5 sec.	MIL-STD-750D METHOD-2026.1 0
3	Pull Test	1 kg in axial lead direction for 10 sec.	MIL-STD-750D METHOD-2036.4
4	Bend Test	0.5Kg Weight Applied To Each Lead, Bending Arcs 90 °C ± 5 °C For 3 Times	MIL-STD-750D METHOD-2036.4
5	High Temperature Reverse Bias Test	TA=100°C for 1000 Hours at VR=80% Rated VR	MIL-STD-750D METHOD-1038.4
6	Forward Operation Life Test	TA=25°C Rated Average Rectified Current	MIL-STD-750D METHOD-1027.3
7	Intermittent Operation Life Test	On state: 5 min with rated IRMS Power Off state: 5 min with Cool Forced Air. On and off for 1000 cycles.	MIL-STD-750D METHOD-1036.3
8	Pressure Cooker Test	15 PSIG, TA=121°C, 4 hours	MIL-S-19500 APPENOIXC
9	Temperature Cycling Test	-55°C~+125°C; 30 Minutes For Dwelled Time 5 minutes for transferred time. Total: 10 cycles.	MIL-STD-750D METHOD-1051.7
10	Thermal Shock Test	0°C for 5 minutes., 100°C for 5minutes, Total: 10 cycles	MIL-STD-750D METHOD-1056.7
11	Forward Surge Test	8.3ms Single Sale Sine-wave One Surge.	MIL-STD-750D METHOD-4066.4
12	Humidity Test	TA=65°C, RH=98% for 1000 hours.	MIL-STD-750D METHOD-1021.3
13	High Temperature Storage life Test	150°C for 1000 Hours	MIL-STD-750D METHOD-1031.5

SMD TRANSISTORS BC85 SERIES CASE SOT-23
SUGGESTED REFLOW PROFILE - For Reference Only

PROFILE FEATURE		PB-FREE ASSEMBLY
Average Ramp-up Rate (Ts Max to Tp)		3°C/second Max
Preheat	Temperature Min (Ts Min.)	150°C
	Temperature Max (Ts Max.)	200°C
	Time (ts Min. to ts Max.)	60~180 seconds
Time maintained above	Temperature (Tl)	217°C
	Time (tl)	60~150 seconds
Peak/Classification Temperature (Tp)		260 °C
Time within 5°C of actual Peak Temperature (tp)		20~40 seconds
Ramp-down rate		6 °C /Second Max.
Time 25 °C to Peak Temperature		8 minutes Max.
Suggest reflow times		3 Times Max.

SMD TRANSISTORS BC85 SERIES CASE SOT-23
TAPE/REEL - Unit: mm

All Devices are packed in accordance with EIA standard RS-481-A and specifications. SOT-23 parts are shipped in tape. The carrier tape is made from a dissipative (carbon filled) polycarbonate resin. The cover tape is a multilayer film (Heat Activated Adhesive in nature) primarily composed of polyester film, adhesive layer, sealant, and anti-static sprayed agent. These reeled parts in standard option are shipped with 3,000 units per 7" or 17.8cm diameter reel. The reels are clear in color and is made of polystyrene plastic (anti-static coated).

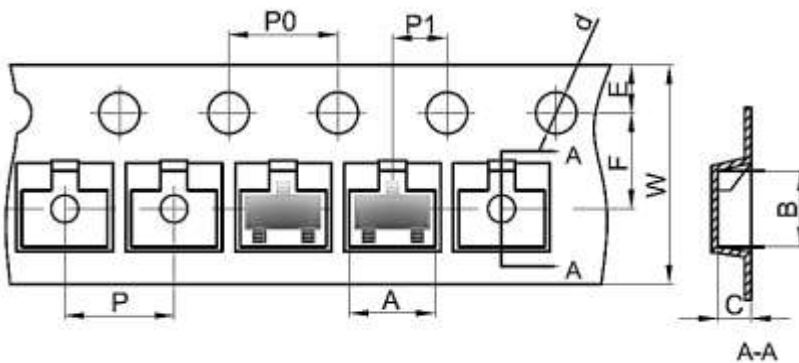

Symbol	Dimension (mm)
A	3.15±0.1
B	2.77±0.1
C	1.22±0.1
d	φ1.50±0.1
E	1.75±0.1
F	3.50±0.1
P0	4.00±0.1
P	4.00±0.1
P1	2.00±0.1
W	8.00±0.1
D	φ178±2
D1	54.4±1
D2	13.0±1
G	R78±1
H	R25.6±1
I	R6.5±1
W1	9.5±1
W2	12.3±1

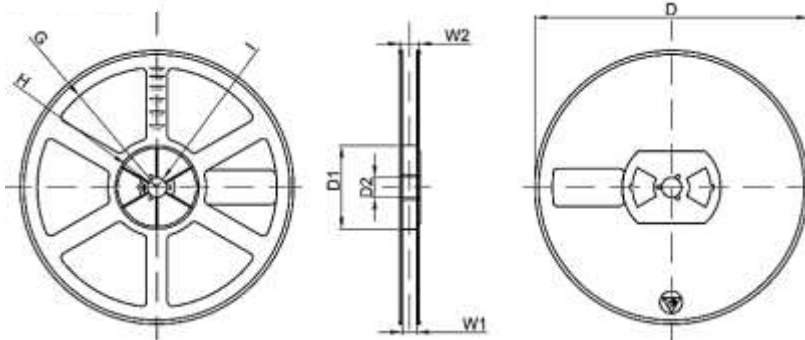
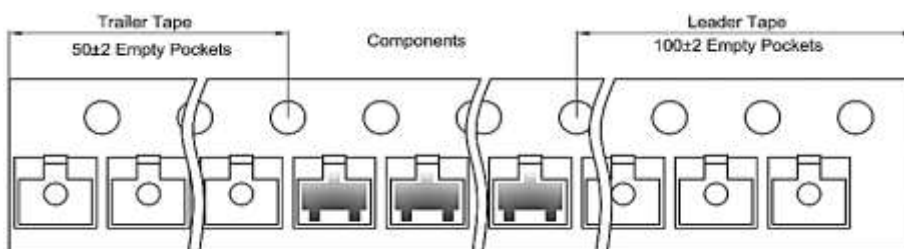
TAPE LEADER AND TRAILER

SMD TRANSISTORS BC85 SERIES CASE SOT-23

IMPORTANT NOTES AND DISCLAIMER

1. **ROHS COMPLIANCE:** The levels of RoHS restricted materials in this product are below the maximum concentration values (also referred to as the threshold limits) permitted for such substances, or are used in an exempted application, in accordance with EU RoHS Directive (EU) 2015/863 EC (RoHS3). RoHS Test Report for this product can be obtained at Download Center.
2. **REACH COMPLIANCE:** REACH substances of high concern (SVHCs) information is available for this product. Since the European Chemical Agency (ECHA) has published notice of their intent to frequently revise the SVHC listing for the foreseeable future, REACH Test Report for this product can be obtained at Download Center.
3. All Product parametric performance is indicated in the Electrical Characteristics for the listed herein test conditions, unless otherwise noted. Product performance may not be indicated by the Electrical Characteristics if operated under different conditions.
4. NextGen Component, Inc (*NextGen*) reserves the right to make changes to this document and its products and specifications at any time without notice. Customers should obtain and confirm the latest product information and specifications before final design, purchase or use.
5. *NextGen* makes no warranty, representation or guarantee regarding the suitability of its products for any particular purpose, not does *NextGen* assume any liability for application assistance or customer product design.
6. *NextGen* does not warrant or accept any liability with products which are purchased or used for any unintended or unauthorized application. No license is granted by implication or otherwise under any intellectual property rights of NextGen.
7. *NextGen* products are not authorized for use as critical components in life support devices or systems without express written approval by *NextGen*.
8. *NextGen* requires that customers first obtain an RMA (Returned Merchandise Authorization) number prior to returning any products. Returns must be made within 30 days of the date of invoice, be in the original packaging, unused and like-new condition. At the time of quoting or purchasing, a product may say that it is Non-Cancelable/ Non-Returnable (NCNR). These products are not returnable and not refundable.