



SPECIFICATION SHEET

SPECIFICATION SHEET NO.	R0720- NC1M120C75RRNG	
DATE	July 20, 2024	
REVISION	A2	Updated With Most Recent Data
DESCRIPTION AND MAIN PARAMETRICS	<p>Silicon Carbide (SiC) MOSFET, TO-263-7L, NC1M Series, 7 Pins N-Channel, Drain-Source Voltage (V_{DS}): 1200V, Industrial Grade Continuous Drain Current (I_D) @25°C: 47A Drain-Source On-State Resistance R_{DS(ON)}: 75 mΩ Operating Temperature: -55°C ~ 175°C (T_J) Package in Tape & Reel RoHS/RoHS III compliant and HF Free</p>	
CUSTOMER		
CUSTOMER PART NO.		
CROSS REF. PART NO.		
ORIGINAL MFG/PART NO.	NovuSem/NC1M120C75RR	
PART CODE	NC1M120C75RRNG	

VENDOR APPROVE			
Issued/Checked/Approved			
DATE: July 20, 2024			

CUSTOMER APPROVE	
DATE:	

SILICON CARBIDE (SiC) MOSFET TO2637L NC1M SERIES

DESCRIPTION

Silicon Carbide (SiC) MOSFET is produced to spec in accordance by NovuSem with industrial standards. The cost-effective NC1M series products drastically lower both static and dynamic losses. In higher frequency applications, our products can shrink system components such as inductors, capacitors, filters, and transformers, which can increase the overall power density and reduce the total system cost.

MAIN FEATURE

- Low Switching Loss
- Short-circuit Capability(>3 μ s).
- High Avalanche Ruggedness
- 175°C Operating Junction Temperature
- High Blocking Voltage With Low On-resistance
- High Speed Switching With Low Capacitances
- Fast Intrinsic Diode With Low Reverse Recovery (Q rr)
- RoHS/RoHS III/REACH Compliant and HF Free



APPLICATION

- PV Inverters
- Charging Piles
- Energy Storage Systems
- Industrial Power Supply
- Industrial Motors.

SILICON CARBIDE (SiC) MOSFET TO2637L NC1M SERIES

PART CODE GUIDE

RFQ

[Request For Quotation](#)

CODE	NAME	KEY SPECIFICATION OPTION
NC1M	Product Series Code	NC1D: Novusem Silicon Carbide (SiC) Schottky Diode Gen 1 Industrial Grade series code NC1M: NovuSem Silicon Carbide (SiC) MOSFET Gen 1 Industrial Grade series code
120	Drain-Source Voltage (V _{DS}) code	120: 1200V; 65: 650V
C	Material code	C: SiC; S: Silicon
75	Drain-Source On-State Resistance R _{DS(ON)} Code	12:12mΩ ; 40: 40mΩ; 75: 75mΩ; 80: 80mΩ
R	Case Code	A: TO-220-2L; D: TO-252; F: TO-220F; G: TO-247-3L; H: TO-247-4L; K: TO-247-2L; M: DFN5X6 R: TO-263-7L; S: TO-263; T: TO-220-3L
R	Package Type Code	T: Tube; R: Tape & Reel
NG	Internal Control Code	Internal Control Code, letter or digits (A~Z, a~z or 1~9) for Special Parametric; Blank: N/A

SILICON CARBIDE (SiC) MOSFET TO2637L NC1M SERIES

DIMENSION – See Table 1 (Unit: mm)

1). All dimensions are listed in millimeters, angles are in degrees. 2). All Metal Surfaces are Tin Plate (Matte) except Area of Cut.

Image for reference



Marking:

Line 1: Initial Part Code

Line 2/Line 3: Internal QC Code

Case: TO-263-7L

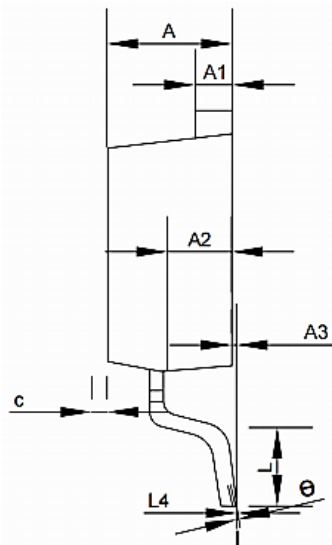
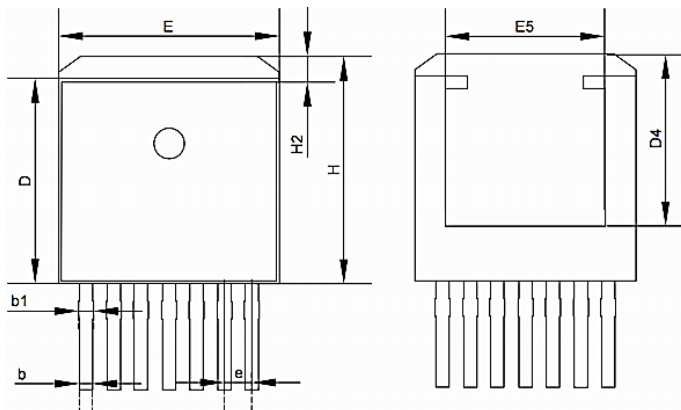
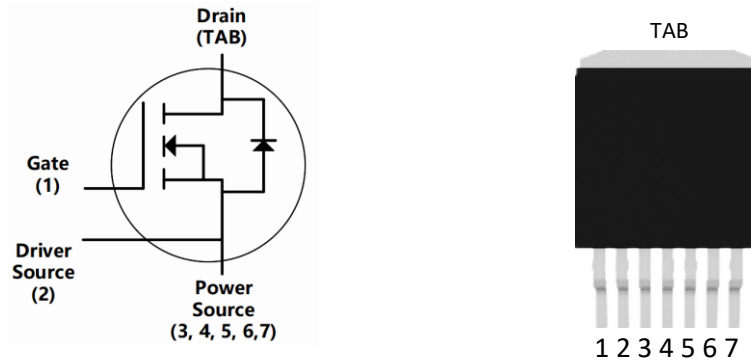

Table 1

SYMBOL	TO-263-7L		
	MIN.	TYP.	MAX.
A	4.25	4.40	4.55
A1	1.20	1.30	1.40
A2	2.25	2.40	2.55
A3	0.01	0.13	0.25
b	0.50	0.60	0.70
b1	0.58	0.68	0.84
c	0.40	0.50	0.60
D	9.05	9.25	9.45
D4	6.90	-	-
e	1.27 Basic		
E	0.80	10.00	10.20
E5	7.25	-	-
H	14.65	15.00	15.35
H2	0.80	1.00	1.20
L	2.40	2.70	3.00
L4	0.25 Basic		
θ°	2	5	8

SILICON CARBIDE (SiC) MOSFET TO2637L NC1M SERIES
INTERNAL CIRCUIT DIAGRAM

Pin 1 (G): Gate; Pin 2 (D): Drain Source; Pin 3,4,5,6,7 (S): Power Source; TAB: Drain

1200V N-CHANNEL SiC MOSFET

V_{DS}	$I_D @ 25^\circ\text{C}$	$R_{DS(on)}$	PACKAGE/CASE
1200V	47A	75m Ω	TO-263-7L

MAX. RATINGS @ $T_c=25^\circ\text{C}$ (Unless Otherwise Specified)

PARAMETER	SYMBOL	TEST CONDITIONS	VALUE	UNIT
Drain-Source Voltage	V_{DSMax}	$V_{GS}=0V, I_D=100\mu A$	1200	V
Gate-Source Voltage	V_{GSop}	Static	-5/+20	V
Continuous Drain Current	I_D	$V_{GS}=20V, T_c=25^\circ\text{C}$	47	A
		$V_{GS}=20V, T_c=100^\circ\text{C}$	33	
Pulsed Drain Current	I_D (pulse)	Pulse width t_p limited by T_{jmax}	70	A
Power Dissipation	P_D	$T_c=25^\circ\text{C}, T_j=175^\circ\text{C}$	288	W
Operating Junction Temperature Range	T_J		-55 ~ +175	$^\circ\text{C}$
Storage Temperature Range	T_{STG}		-55 ~ +175	$^\circ\text{C}$

SILICON CARBIDE (SiC) MOSFET TO2637L NC1M SERIES
ELECTRICAL CHARACTERISTICS @Tc=25 °C (Unless Otherwise Specified) – Part 1

PARAMETER	SYMBOL	CONDITIONS	VALUE			UNIT
			Min.	Typ.	Max.	
Drain-Source Breakdown Voltage	V (BR) DSS	VGS=0V I D=100μA	1200	-	-	V
Gates Threshold Voltage	V GS(th)	VDS=VGS, ID=5mA	-	2.8	-	V
		VDS=VGS, ID=5mA, Tj=175°C	-	1.9	-	
Zero Gates Voltage Drain Crurent	I DSS	VDS=1200V, VGS=0V	-	1	-	μA
Gates-Source Leakage Crurent	I GSS	VGS=20V, VDS=0V	-	10	-	nA
Drain-Source On-State Resistance	R DS (ON)	VGS=20V, ID=20A	-	75	-	mΩ
		VGS=20V, ID=20A, Tj=175°C	-	133	-	
		VGS=18V, ID=20A,	-	82	-	
		VGS=18V, ID=20A, Tj=175°C	-	137	-	
Transconductance	g fs	VDS=20V, IDS=20A	-	10	-	S
		V DS=20V, IDS=20A, Tj=175°C	-	11	-	
Turn-On Switching Energy (Body Diode FWD)	E on	VDS=800V, VGS=-5V/20V, ID=20A, R G(ext) =2.5Ω, L=200μH, Tj=25°C FWD=NC1M120C75RR	-	262	-	μJ
Turn-Off Switching Energy (Body Diode FWD)	E off		-	108	-	μJ
Turn-On Delay Time	t d (on)	VDD=800V, VGS =-5V/20V, I D =20A, R G(ext) =2.5Ω, L=200μH	-	11	-	ns
Rise Time	t r		-	24	-	ns
Turn-Off Delay Time	t d(off)		-	20	-	ns
Fall Time	t f		-	12	-	ns

SILICON CARBIDE (SiC) MOSFET TO2637L NC1M SERIES
ELECTRICAL CHARACTERISTICS @Tc=25 °C (Unless Otherwise Specified) – Part 2

PARAMETER	SYMBOL	CONDITIONS	VALUE			UNIT
			Min.	Typ.	Max.	
Gate to Source Charge	Q _{gs}	V _{DS} =800V, V _{GS} =-5V/20V, I _D =20A	-	35	-	nC
Gate to Drain Charge	Q _{gd}		-	25	-	nC
Total Gate Charge	Q _g		-	87	-	nC
Input Capacitance	C _{iss}	V _{GS} =0V, V _{DS} =1000V f=1MHz V _{AC} =25mV	-	1450	-	pF
Output Capacitance	C _{oss}		-	66	-	pF
Reverse Transfer Capacitance	C _{rss}		-	13	-	pF
COSS Stored Energy	E _{oss}		-	40	-	μJ
Internal Gate Resistance	R _{G (int)}	f=1MHz, V _{AC} =25mV	-	2.4	-	Ω

REVERSE DIODE CHARACTERISTICS @Tc=25 °C (Unless Otherwise Specified)

PARAMETER	SYMBOL	CONDITIONS	VALUE			UNIT
			Min.	Typ.	Max.	
Diode Forward Voltage	V _{SD}	V _{GS} =-5V, I _{SD} =10A	-	4.9	-	V
		V _{GS} =-5V, I _{SD} =10A, T _j =175°C	-	4.0	-	V
Continuous Diode Forward Current	I _S	V _{GS} =-5V	-	46	-	A
Reverse Recovery Time	t _{rr}	V _{GS} =-5V, I _{SD} =20A V _R =800V, di/dt=2800A/μs	-	12	-	ns
Reverse Recovery Charge	Q _{rr}		-	221	-	nC
Peak Reverse Recovery Current	I _{rrm}		-	19	-	A

THERMAL CHARACTERISTICS

PARAMETER	SYMBOL	VALUE			UNIT
		Min.	Typ.	Max.	
Thermal Resistance from Junction to Case	R _{θJC}	-	0.52	-	°C/W

SILICON CARBIDE (SiC) MOSFET TO2637L NC1M SERIES

TYPICAL PERFORMANCE - For Reference Only

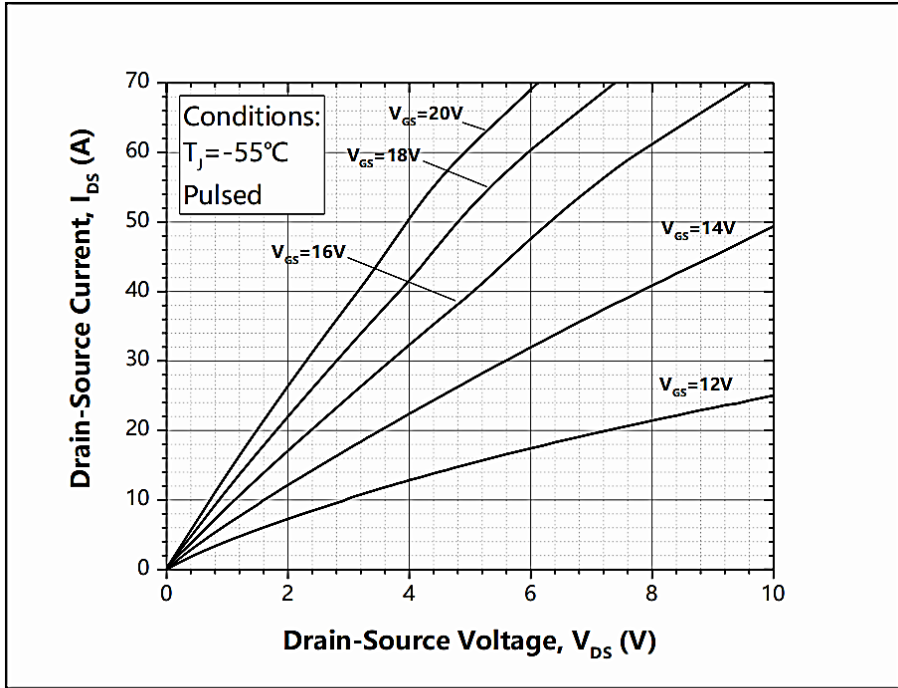

Figure 1. Output Characteristics $T_j = -55^\circ\text{C}$

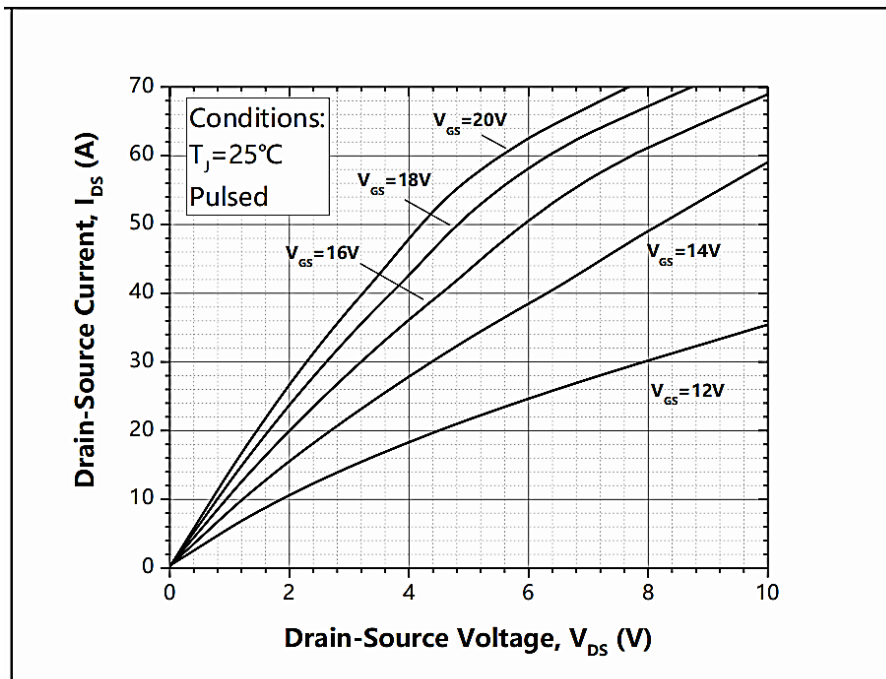

Figure 2. Output Characteristics $T_j = 25^\circ\text{C}$

SILICON CARBIDE (SiC) MOSFET TO2637L NC1M SERIES

TYPICAL PERFORMANCE - For Reference Only

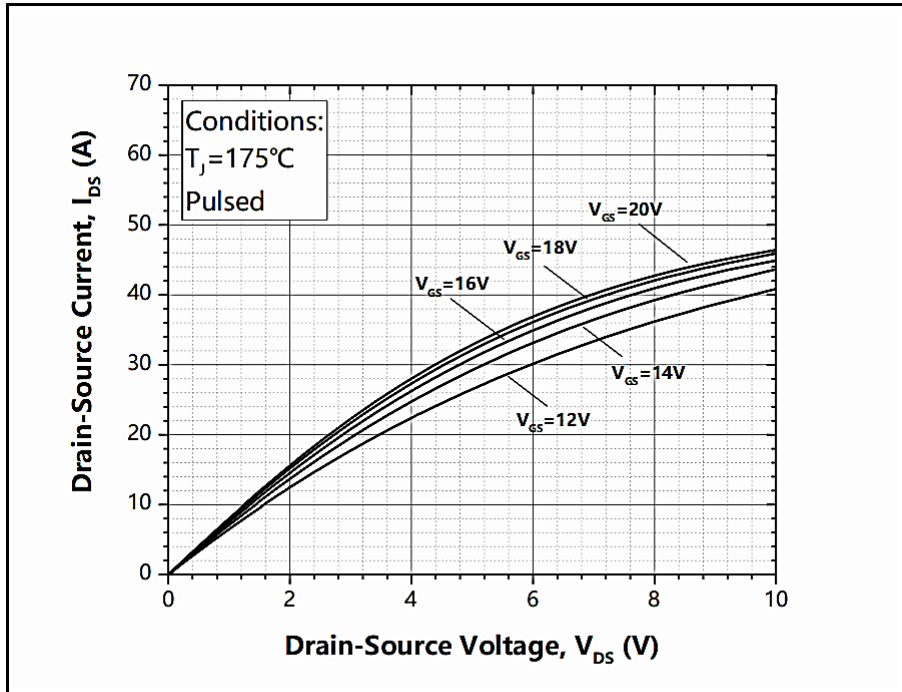

Figure 3. Output Characteristics $T_J = 175^\circ\text{C}$

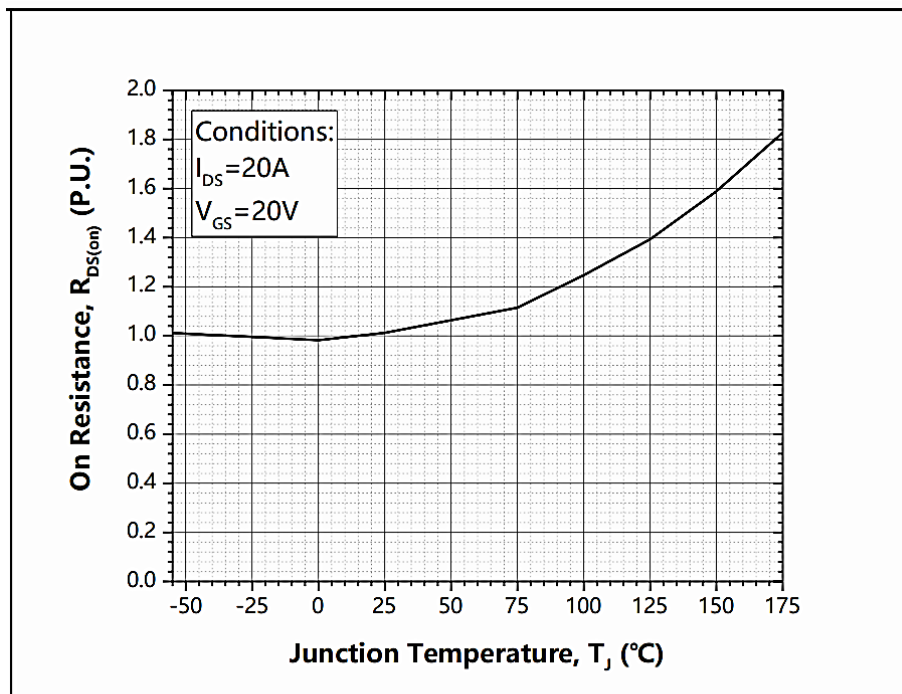

Figure 4. Normalized On-Resistance vs. Temperature

SILICON CARBIDE (SiC) MOSFET TO2637L NC1M SERIES

TYPICAL PERFORMANCE - For Reference Only

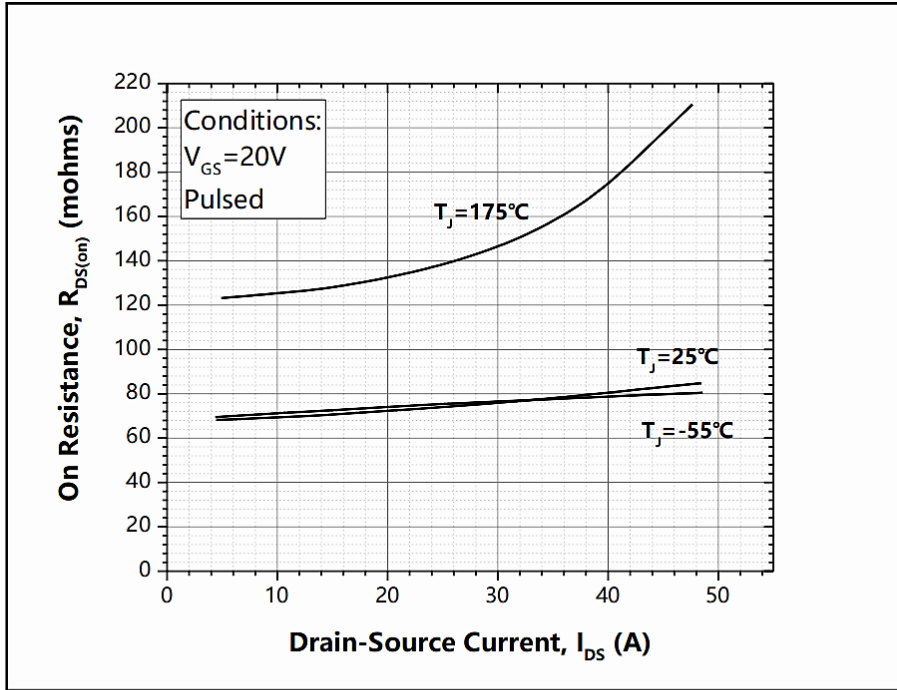

Figure 5. On-Resistance vs. Drain Current For Various Temperatures

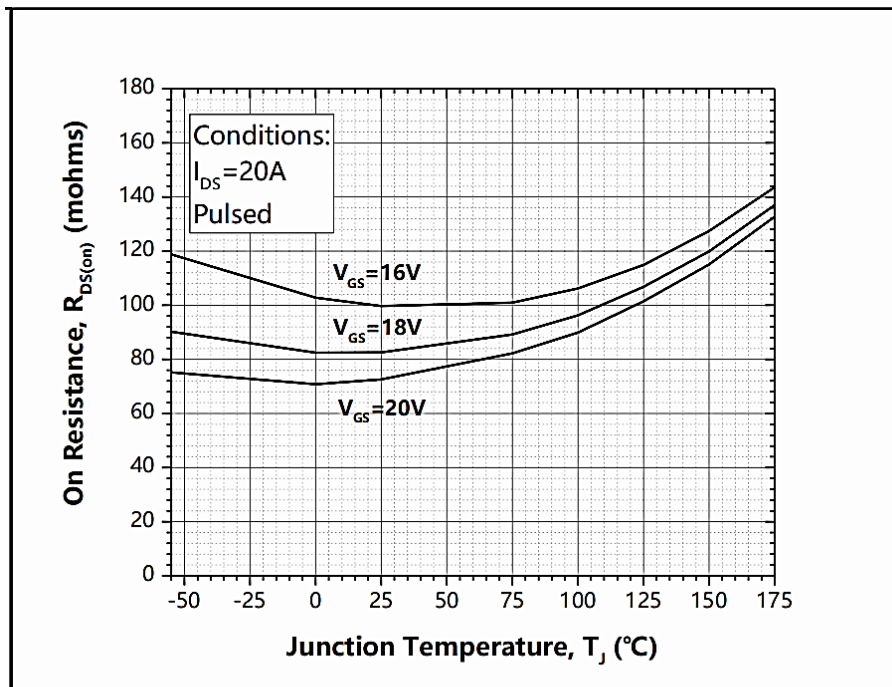

Figure 6. On-Resistance vs. Temperature For Various Gate Voltage

SILICON CARBIDE (SiC) MOSFET TO2637L NC1M SERIES

TYPICAL PERFORMANCE - For Reference Only

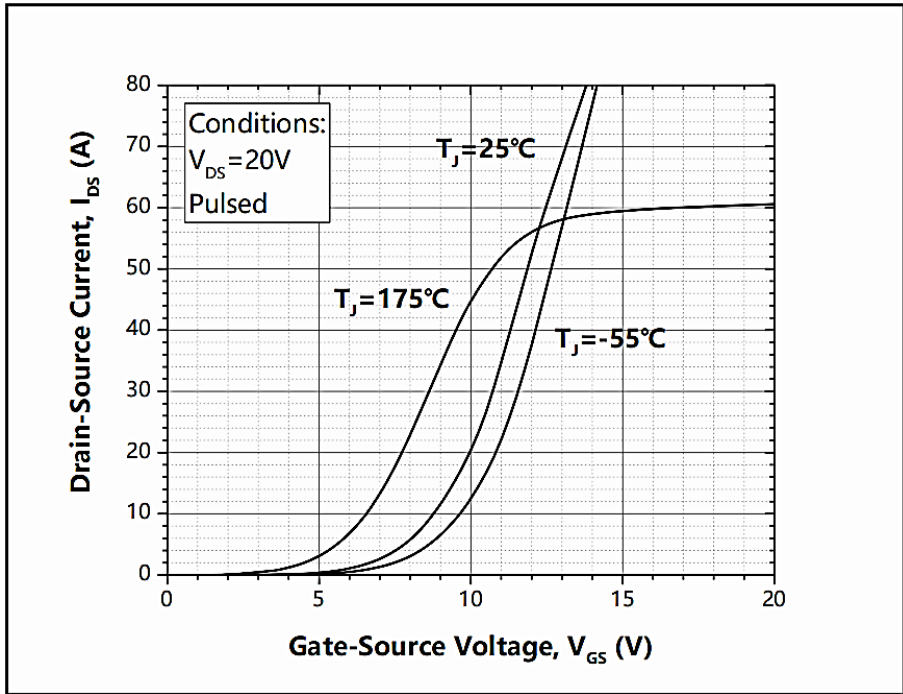

Figure 7. Transfer Characteristic for Various Junction Temperatures

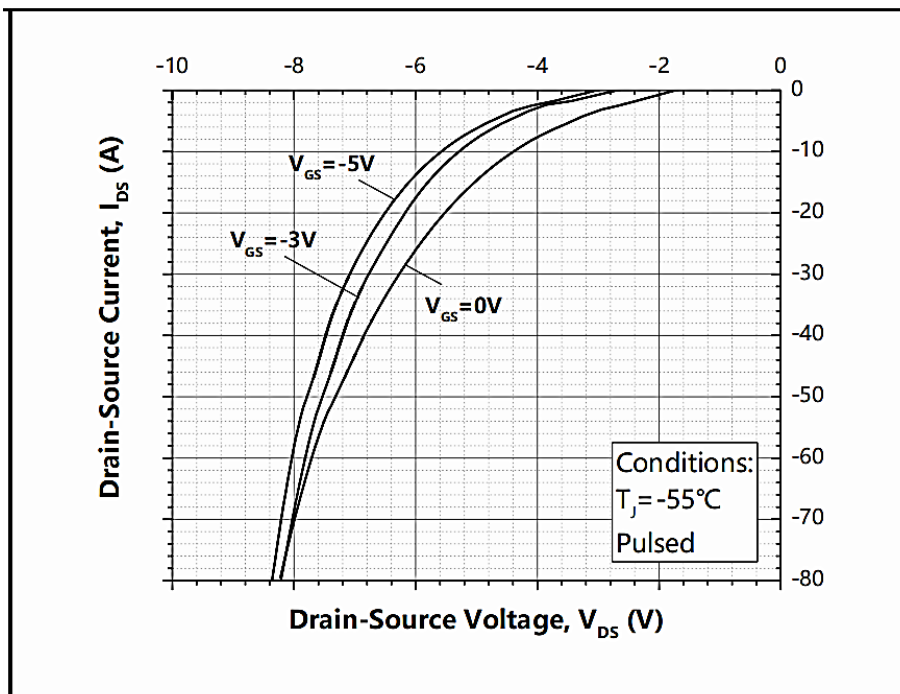

Figure 8. Body Diode Characteristic at -55°C

SILICON CARBIDE (SiC) MOSFET TO2637L NC1M SERIES

TYPICAL PERFORMANCE - For Reference Only

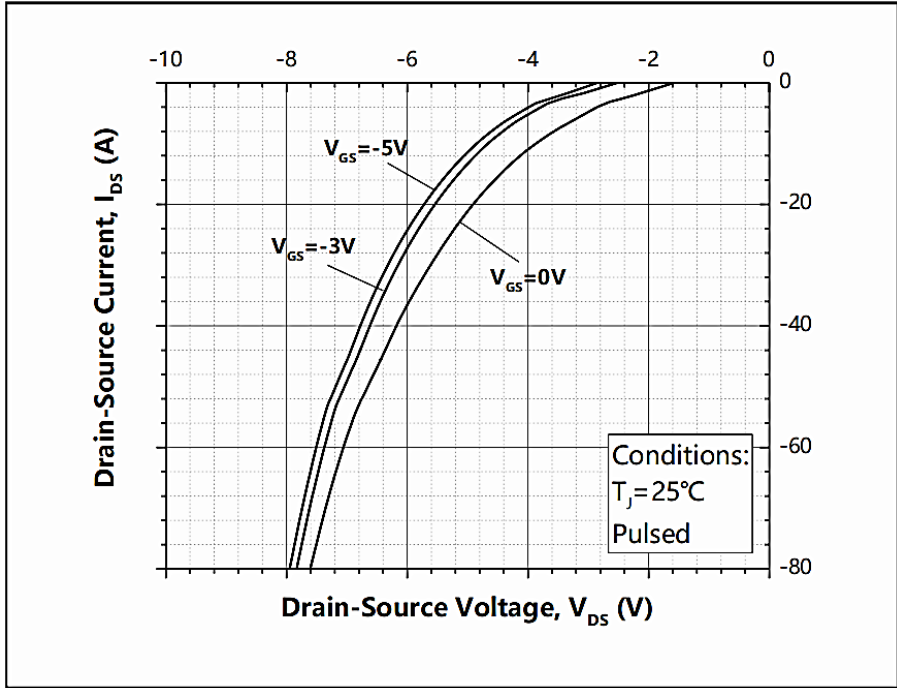

Figure 9. Body Diode Characteristic at 25°C

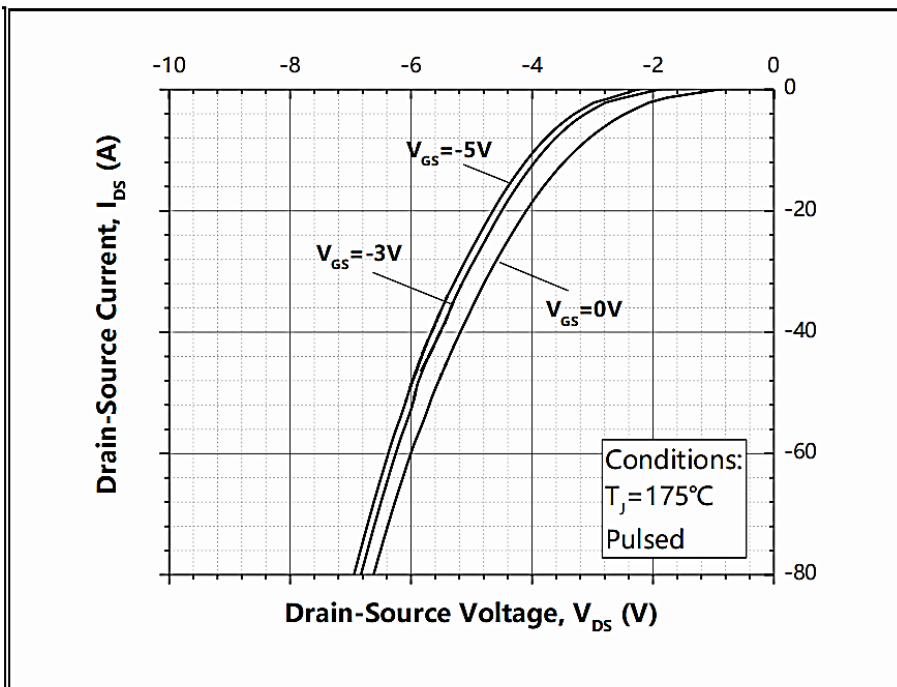

Figure 10. Body Diode Characteristic at 175°C

SILICON CARBIDE (SiC) MOSFET TO2637L NC1M SERIES

TYPICAL PERFORMANCE - For Reference Only

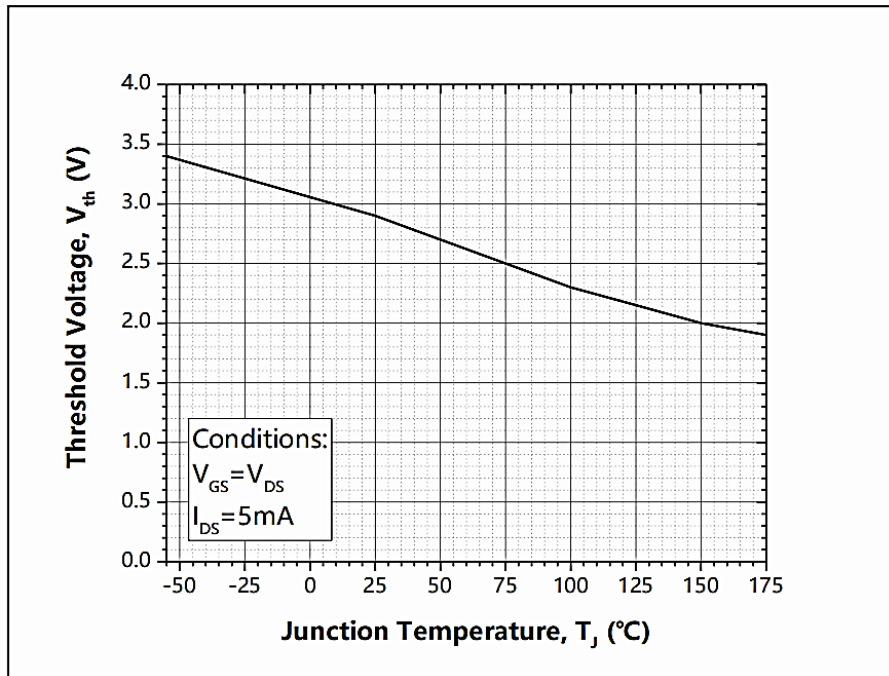

Figure 11. Threshold Voltage vs. Temperature

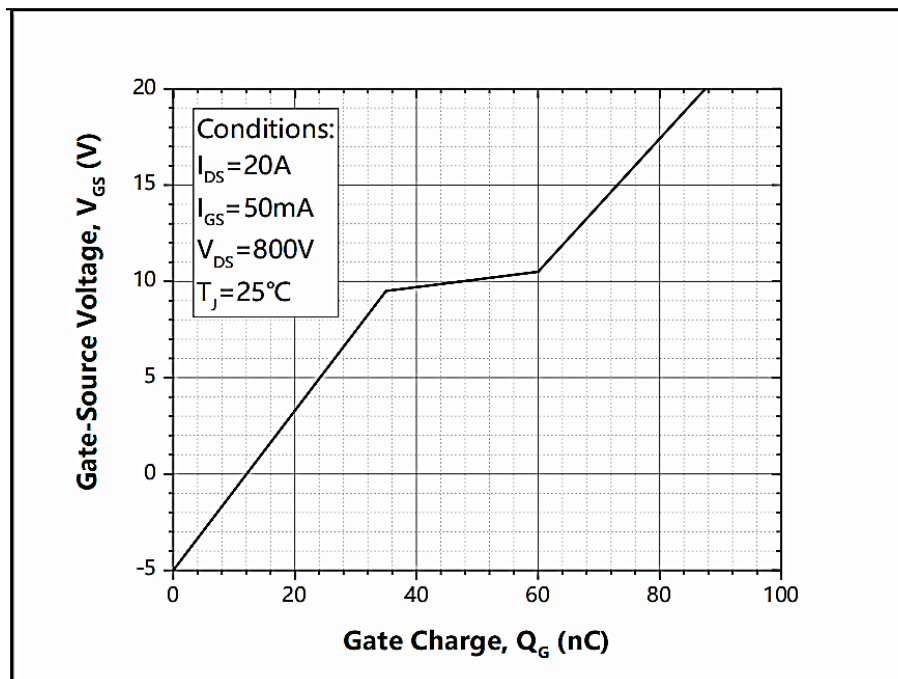

Figure 12. Gate Charge Characteristics

SILICON CARBIDE (SiC) MOSFET TO2637L NC1M SERIES

TYPICAL PERFORMANCE - For Reference Only

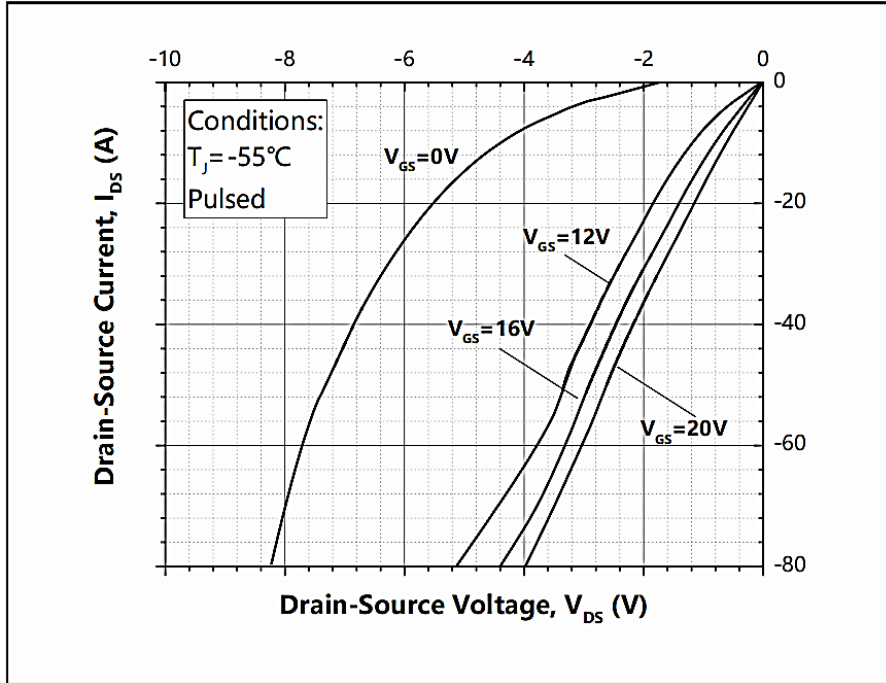

Figure 13. 3rd Quadrant Characteristic at -55°C

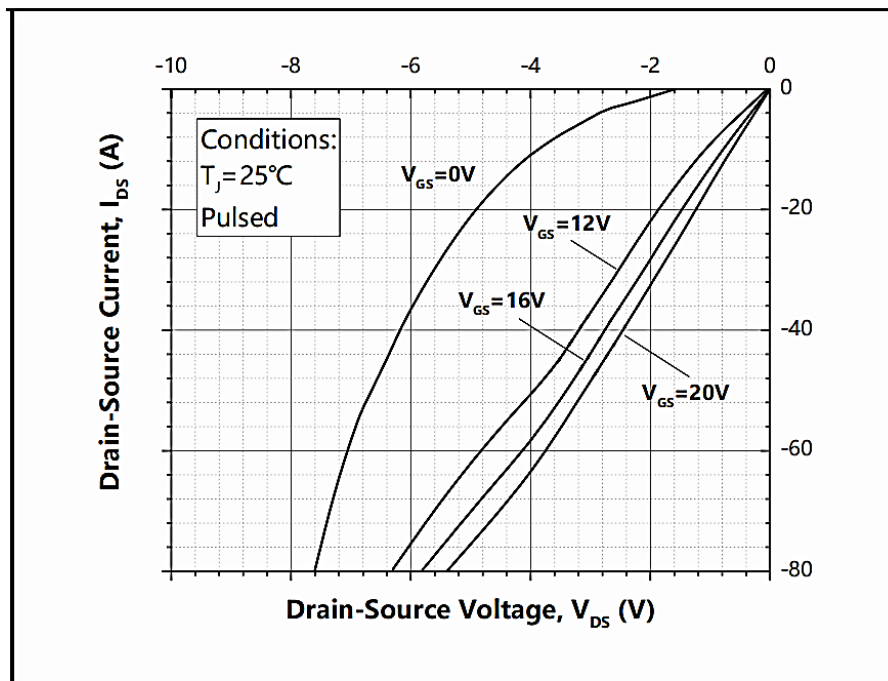

Figure 14. 3rd Quadrant Characteristic at 25°C

SILICON CARBIDE (SiC) MOSFET TO2637L NC1M SERIES

TYPICAL PERFORMANCE - For Reference Only

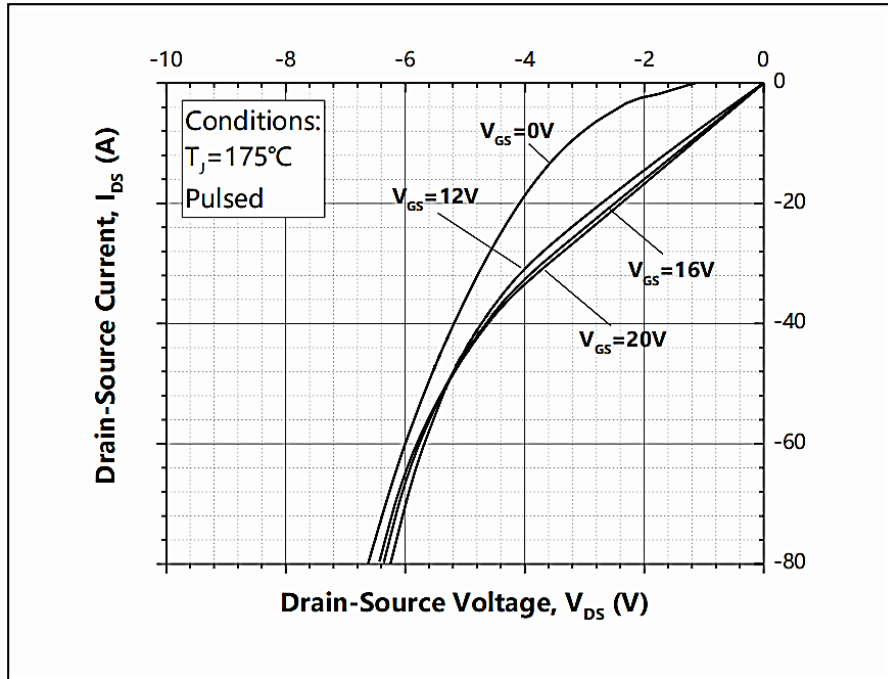

Figure 15. 3rd Quadrant Characteristic at 175°C

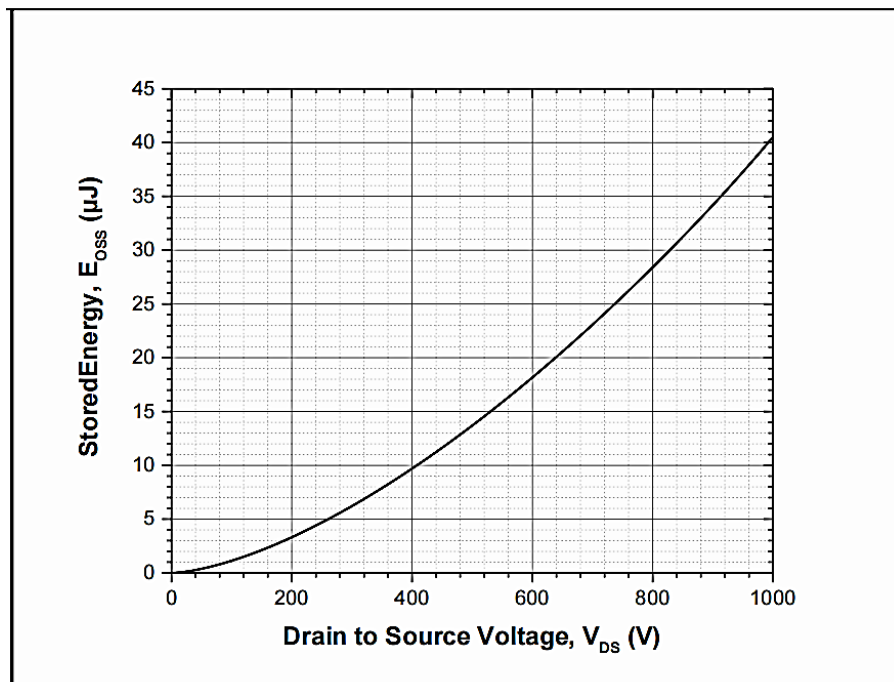

Figure 16. Output Capacitor Stored Energy

SILICON CARBIDE (SiC) MOSFET TO2637L NC1M SERIES

TYPICAL PERFORMANCE - For Reference Only

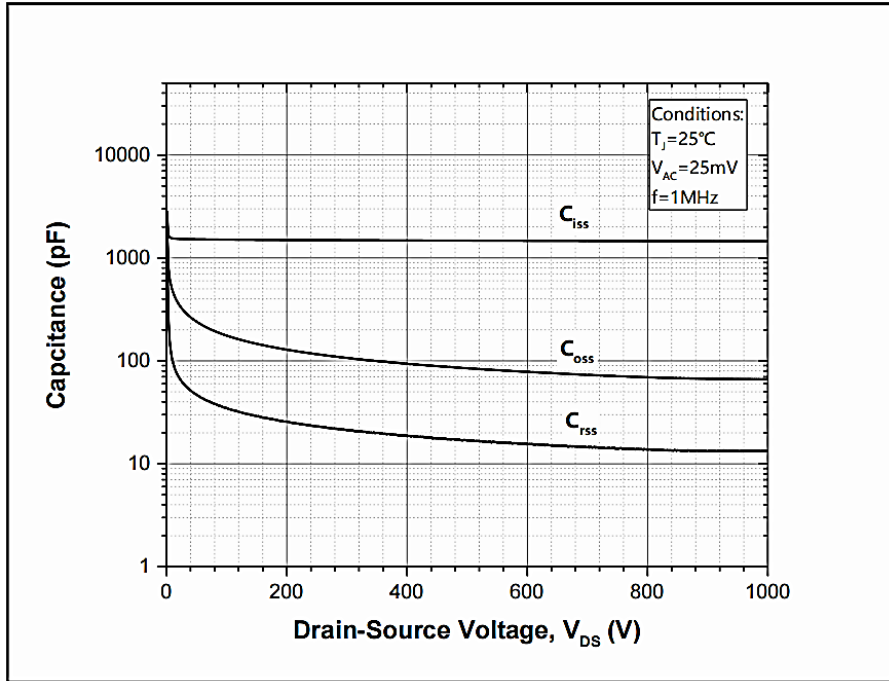

Figure 17. Capacitances vs. Drain-Source Voltage

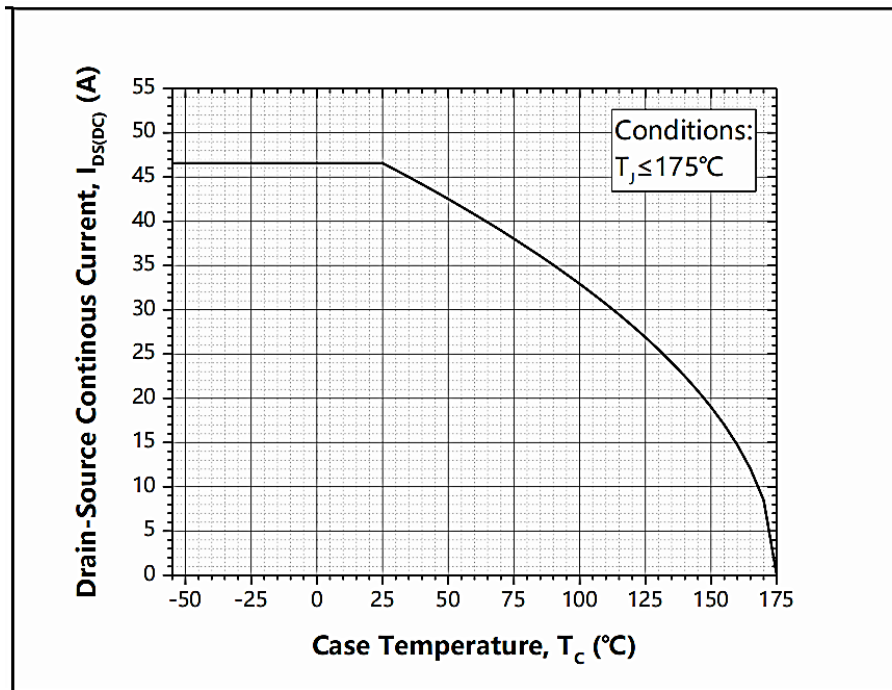

Figure 18. Continuous Drain Current Derating vs. Case Temperature

SILICON CARBIDE (SiC) MOSFET TO2637L NC1M SERIES

TYPICAL PERFORMANCE - For Reference Only

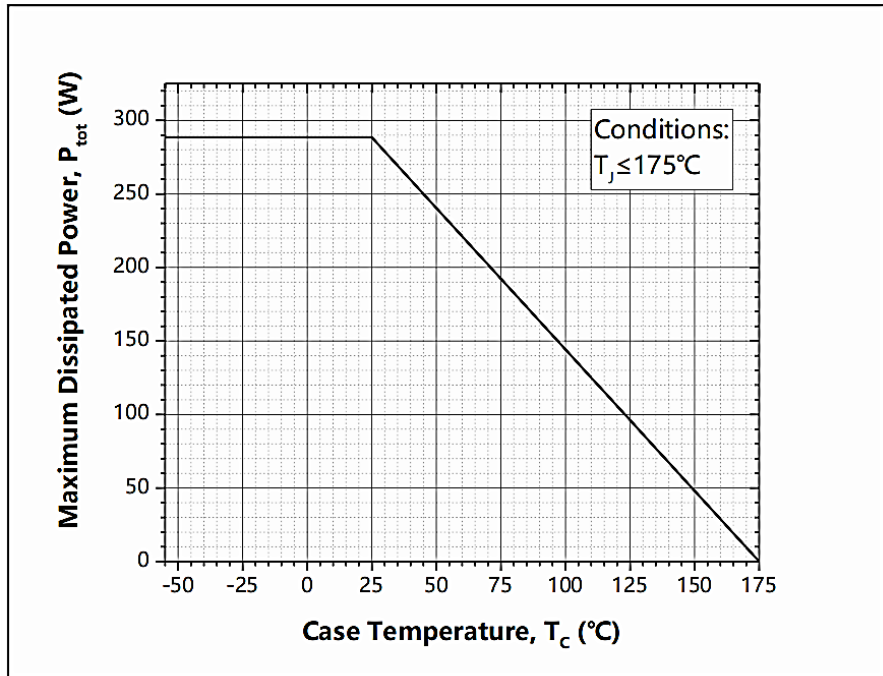

Figure 19. Maximum Power Dissipation Derating vs. Case Temperature

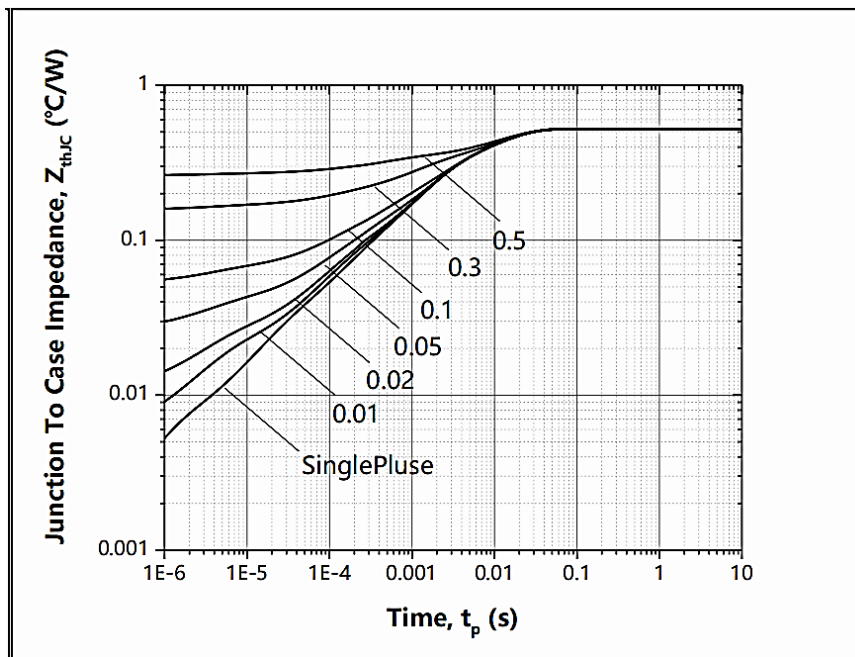

Figure 20. Transient Thermal Impedance (Junction - Case)

SILICON CARBIDE (SiC) MOSFET TO2637L NC1M SERIES

TYPICAL PERFORMANCE - For Reference Only

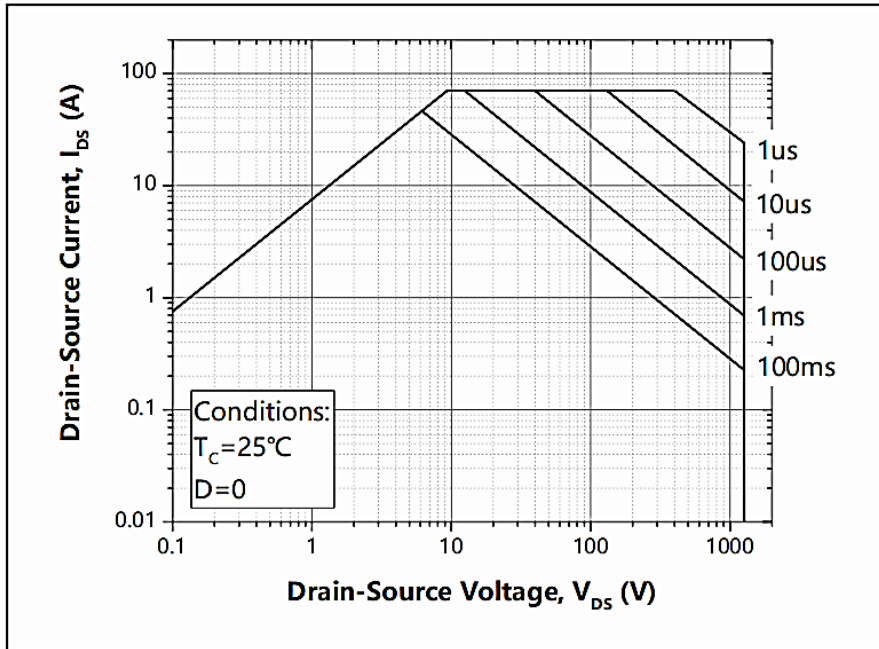

Figure 21. Safe Operating Area

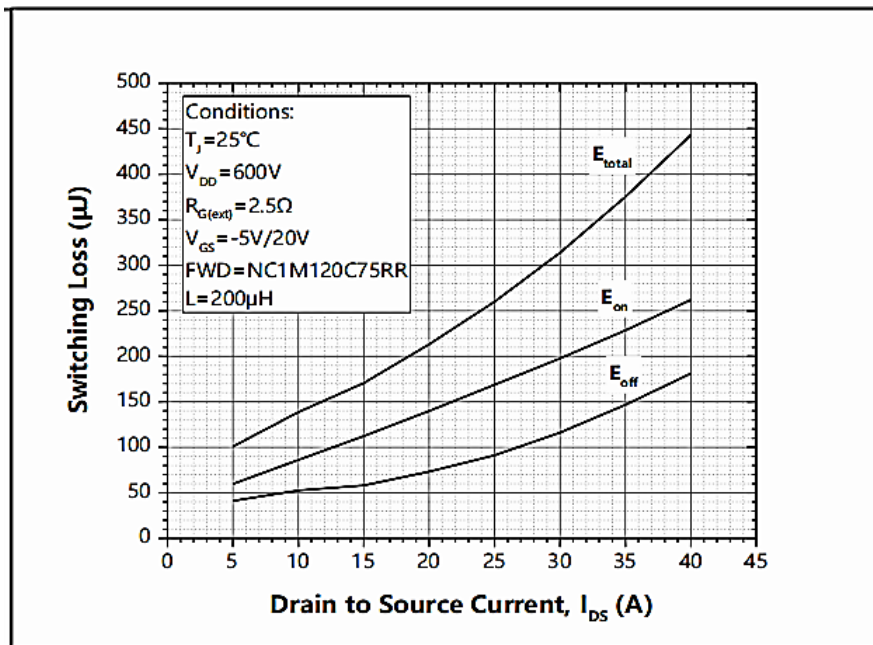

Figure 22. Clamped Inductive Switching Energy vs. Drain Current ($V_{DD} = 600\text{V}$)

SILICON CARBIDE (SiC) MOSFET TO2637L NC1M SERIES

TYPICAL PERFORMANCE - For Reference Only

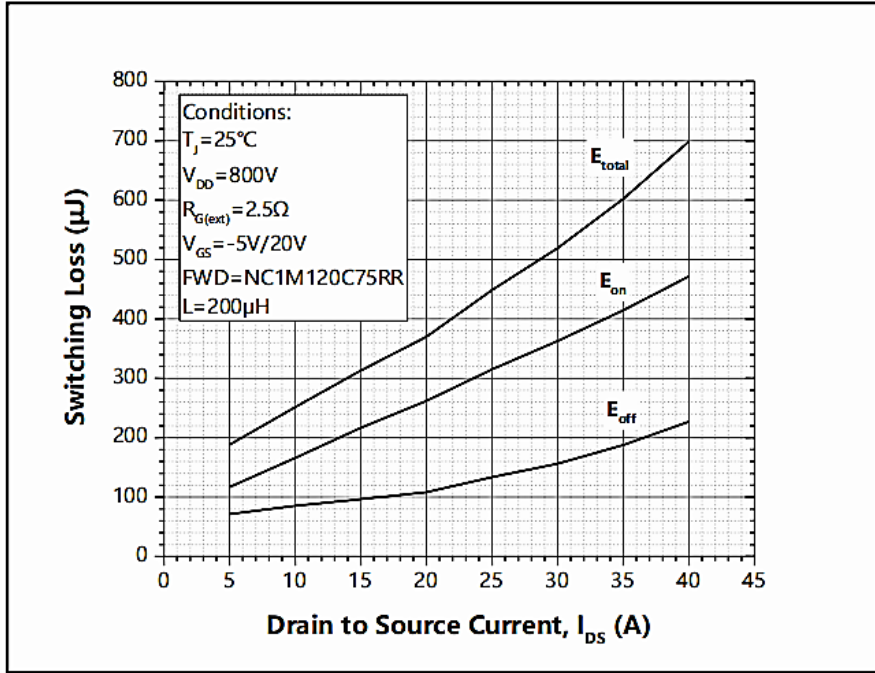

Figure 23. Clamped Inductive Switching Energy vs. Drain Current ($V_{DD}=800V$)

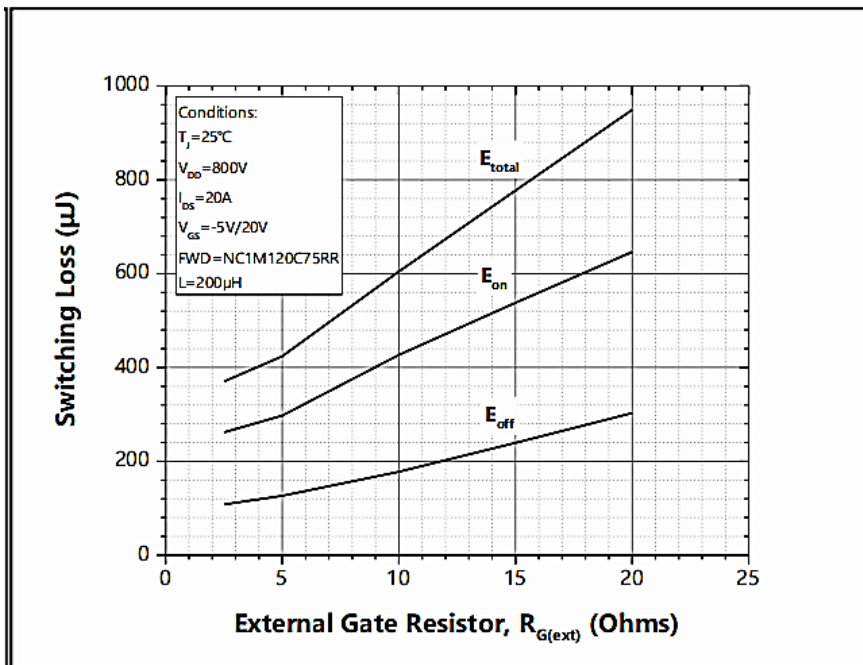

Figure 24. Clamped Inductive Switching Energy vs. $R_{G(ext)}$

SILICON CARBIDE (SiC) MOSFET TO2637L NC1M SERIES

TYPICAL PERFORMANCE - For Reference Only

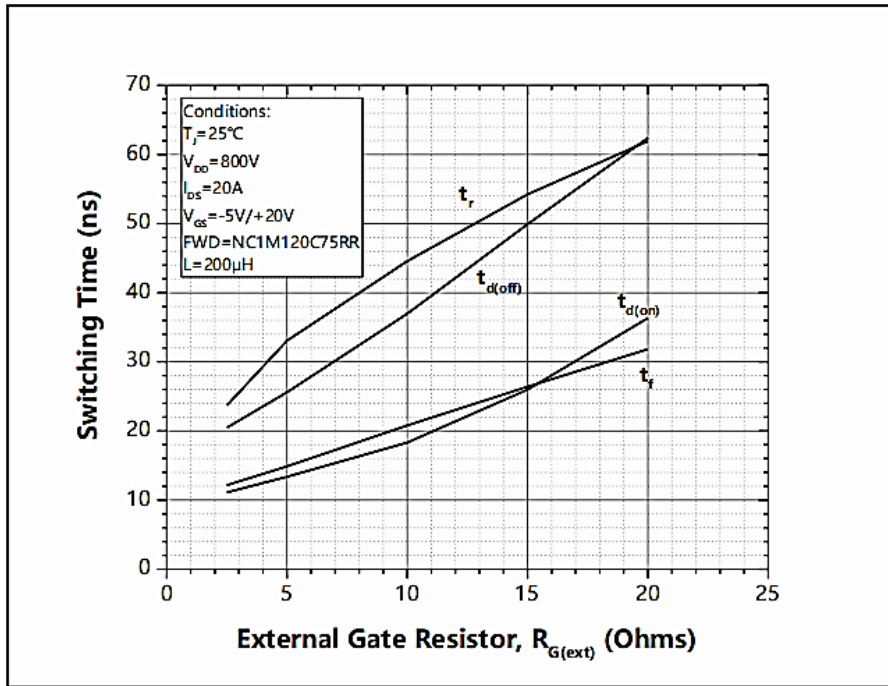

Figure 25. Switching Time vs. $R_{G(ext)}$

SILICON CARBIDE (SiC) MOSFET TO2637L NC1M SERIES

IMPORTANT NOTES AND DISCLAIMER

1. **ROHS COMPLIANCE:** The levels of RoHS restricted materials in this product are below the maximum concentration values (also referred to as the threshold limits) permitted for such substances, or are used in an exempted application, in accordance with EU RoHS Directive (EU) 2015/863 EC (RoHS3). RoHS Test Report for this product can be obtained at Download Center.
2. **REACH COMPLIANCE:** REACH substances of high concern (SVHCs) information is available for this product. Since the European Chemical Agency (ECHA) has published notice of their intent to frequently revise the SVHC listing for the foreseeable future, REACH Test Report for this product can be obtained at Download Center.
3. All Product parametric performance is indicated in the Electrical Characteristics for the listed herein test conditions, unless otherwise noted. Product performance may not be indicated by the Electrical Characteristics if operated under different conditions.
4. NextGen Component, Inc (*NextGen*) reserves the right to make changes to this document and its products and specifications at any time without notice. Customers should obtain and confirm the latest product information and specifications before final design, purchase or use.
5. *NextGen* makes no warranty, representation or guarantee regarding the suitability of its products for any particular purpose, not does *NextGen* assume any liability for application assistance or customer product design.
6. *NextGen* does not warrant or accept any liability with products which are purchased or used for any unintended or unauthorized application. No license is granted by implication or otherwise under any intellectual property rights of NextGen.
7. *NextGen* products are not authorized for use as critical components in life support devices or systems without express written approval by *NextGen*.
8. *NextGen* requires that customers first obtain an RMA (Returned Merchandise Authorization) number prior to returning any products. Returns must be made within 30 days of the date of invoice, be in the original packaging, unused and like-new condition. At the time of quoting or purchasing, a product may say that it is Non-Cancelable/ Non-Returnable (NCNR). These products are not returnable and not refundable.