



**SPECIFICATION SHEET**

<b>SPECIFICATION SHEET NO.</b>	R0723- NC1D120C40GTDN	
<b>DATE</b>	July 23, 2024	
<b>REVISION</b>	A1	Updated With Most Recent Data
<b>DESCRIPTION AND MAIN PARAMETRICS</b>	<p>Silicon Carbide (SiC) Enhanced Junction Barrier Schottky Diode (EJBS), TO-247-3L, NC1D Series, 3 Pins, Dual Die, Industrial Grade</p> <p>Repetitive Peak Reverse Voltage (VRRM): 1200V,            Continuous Forward Current (IF) @Tc 152°C: 40A            Operating Junction Temperature Range (Tj,Max): 175°C            Package in Tube            RoHS/RoHS III compliant and HF Free</p>	
<b>CUSTOMER</b>		
<b>CUSTOMER PART NO.</b>		
<b>CROSS REF. PART NO.</b>		
<b>ORIGINAL MFG/PART NO.</b>	NovuSem/NC1D120C40GTD	
<b>PART CODE</b>	NC1D120C40GTDN	

<b>VENDOR APPROVE</b>			
Issued/Checked/Approved			
DATE: July 23, 2024			

<b>CUSTOMER APPROVE</b>	
DATE:	

## SILICON CARBIDE (SiC) SCHOTTKY DIODE TO2473L NC1D SERIES

### DESCRIPTION

Silicon Carbide (SiC) Enhanced Junction Barrier Schottky (EJBS) diode is cost-effective, quality-oriented, and is proven in accordance with industrial standards. SiC Schottky Diode is a composite structure of a PiN Diode and SBD structure. The PiN structure, in the reverse blocking state of the device, is used to shield the electric field of the Schottky region to reduce leakage current. The SBD structure realizes the low forward voltage through unipolar conduction. NovuSem has developed a SiC EJBS diode through the optimization of device structure and manufacturing process, The SiC EJBS diode features ultra-low leakage current (5 $\mu$ A) and high surge current capability comparable to that of the MPS (Merged PiN Schottky) structure.

### MAIN FEATURE

- Zero Reverse Recovery Current/Forward Recovery Voltage
- 175 °C Operating Junction Temperature
- Low Forward Voltage (VF) Drop With Positive Temperature Coefficient
- Temperature-Independent Switching Behavior
- RoHS III Compliant & HF Free



### APPLICATION

- PV Inverters
- Charging Piles
- Energy Storage Systems
- Industrial Power Supply
- Industrial Motors
- Automotive Electronics.

**SILICON CARBIDE (SiC) SCHOTTKY DIODE TO2473L NC1D SERIES**

**APPLICATION PERFORMANCE**

- 1100V PV System Boost PFC: In the application of 11kW PV inverters, compared with FRD, NovuSem SiC EJBS diode reduces system loss by 30%, and reduces temperature increases in silicon-based IGBTs and SiC diodes by 6°C and 13°C respectively, greatly improving overall power density.
- Vienna rectifier for 20 kW charging piles: NovuSem SiC EJBS diode improves system efficiency by 1.05% while reducing switching loss by 91% and total loss by 50% compared to FRD.

**PART CODE GUIDE**

**RFQ**  
Request For Quotation

CODE	NAME	KEY SPECIFICATION OPTION
NC1D	Product Series Code	NC1D: Novusem Silicon Carbide (SiC) Schottky Diode Gen 1 Industrial Grade series code NC1M: NovuSem Silicon Carbide (SiC) MOSFET Gen 1 Industrial Grade series code
120	Repetitive Peak Reverse Voltage (V <sub>RRM</sub> ) Code	120: 1200V; 65: 650V
C	Material code	C: SiC; S: Silicon
40	Continuous Forward Current (I <sub>F</sub> )	10: 10A; 20: 20A; 30: 30A; 40: 40A; 60: 60A; 120: 120A
G	Case Code	A: TO-220-2L; D: TO-252; F: TO-220F; G: TO-247-3L; H: TO-247-4L; K: TO-247-2L; M: DFN5X6 R: TO-263-7L; S: TO-263; T: TO-220-3L
T	Package Type Code	T: Tube; R: Tape & Reel
D	Extension code	D: Dual Die; Blank: N/A
N	Internal Control Code	Internal Control Code, letter or digits (A~Z, a~z or 1~9) for Special Parametric; Blank: N/A

**SILICON CARBIDE (SiC) SCHOTTKY DIODE TO2473L NC1D SERIES**

**DIMENSION** – See Table 1 (Unit: mm)

1). All dimensions are listed in millimeters, angles are in degrees. 2). All Metal Surfaces are Tin Plate (Matte) except Area of Cut.

**Image for Reference**



**Marking:**

Line 1: Initial Part Code

Line 2/Line 3: Internal QC Code

Case: TO-247-3L

Table 1

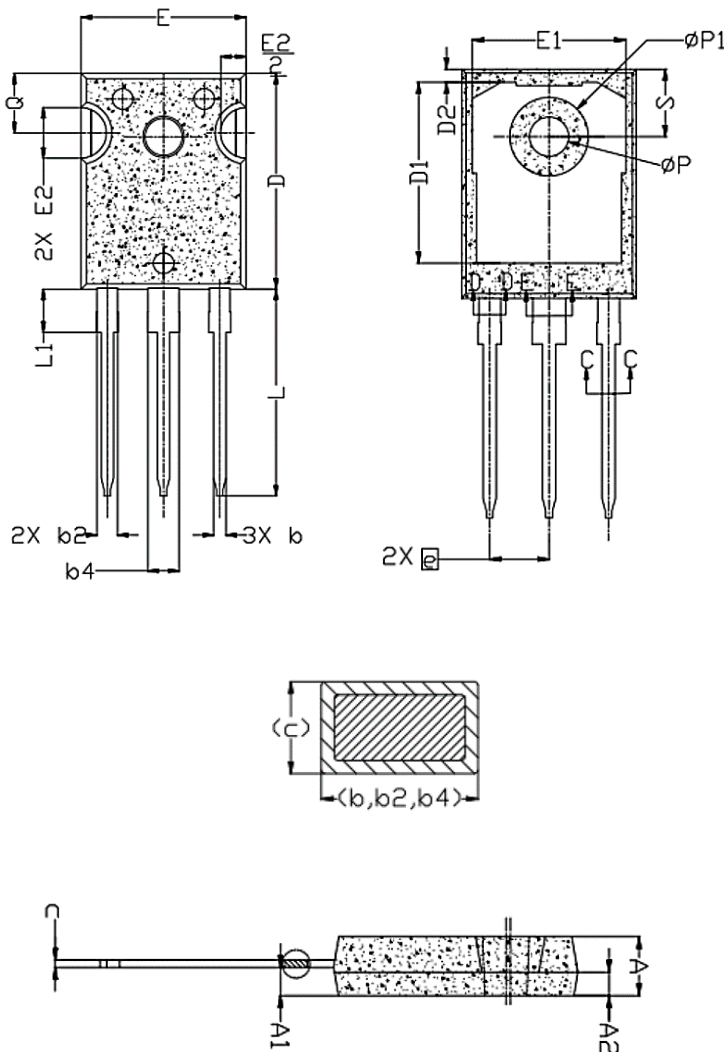

SYMBOL	TO-247-3L		
	Min.	Typ.	Max.
A	4.82	5.02	5.22
A1	2.29	2.41	2.55
A2	1.70	2.00	2.30
b	1.12	1.20	1.33
b2	1.91	2.00	2.39
b4	2.87	3.00	3.22
c	0.55	0.60	0.69
D	20.80	20.95	21.10
D1	16.25	16.55	17.05
D2	0.51	1.19	1.35
E	15.74	15.94	16.14
E1	13.46	14.02	14.16
E2	4.41	4.91	5.41
e	5.44 Basic		
L	19.82	20.07	20.32
L1	4.09	4.19	4.39
ØP	3.57	3.61	3.65
ØP1	7.19 Ref.		
Q	5.39	5.79	6.19
S	6.02	6.17	6.32

**SILICON CARBIDE (SiC) SCHOTTKY DIODE TO2473L NC1D SERIES**

**INTERNAL CIRCUIT DIAGRAM**

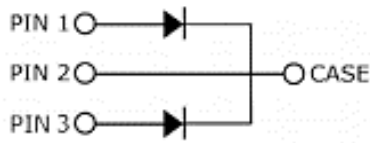

**1200V SiC SCHOTTKY DIODE**

VRRM	IF @ Tc = 152°C	Tj, Max.	PACKAGE/CASE
1200V	40A	175 °C	TO-247-3L

**MAX. RATINGS @Tc=25 °C (Unless Otherwise Specified)**

PARAMETER	SYMBOL	TEST CONDITIONS	VALUE	UNIT
Repetitive Peak Reverse Voltage	VRRM		1200	V
DC Peak Reverse Voltage	VR		1200	V
Continuous Forward Current	IF	Tc=25°C	60*/120**	A
		Tc=135°C	28*/56**	
		Tc=152°C	20*/40**	
Repetitive Peak Forward Surge Current	IFRM	Tc=25°C, tp=10ms, half sine wave, 0.1Hz	200*	A
Non-Repetitive Forward Surge Current	IFSM	Tc=25°C, tp=10ms, half sine wave	220*	A
Power Dissipation	Ptot	Tc=25°C	242*/484**	W
		Tc=110°C	105*/210**	
i <sup>2</sup> t Value	∫i <sup>2</sup> dt	Tc=25°C, tp=10ms	242*	A <sup>2</sup> s
Operating Junction Tempe. Range	Tj		-55 ~ +175	°C
Storage Temperature Range	Tstg		-55 ~ +175	°C

Note: \*: Per Leg; \*\*: Device

7/23/2024

**SILICON CARBIDE (SiC) SCHOTTKY DIODE TO2473L NC1D SERIES**

**ELECTRICAL CHARACTERISTICS @Tc=25 °C (Unless Otherwise Specified)**

PARAMETER	SYMBOL	CONDITIONS	VALUE			UNIT
			Min.	Typ.	Max.	
Forward Voltage	VF	IF=20A, Tj=25°C	-	1.37	1.6	V
		IF=20A, Tj=175°C	-	1.90	2.50	
Reverse Current	IR	VR=1200V, Tj=25°C	-	5	50	µA
		VR=1200V, Tj=175°C	-	30	200	
Total Capacitance	C	VR=0.1V, f=1MHz	-	1371	-	pF
		VR=400V, f=1MHz	-	104	-	
		VR=800V, f=1MHz	-	79	-	
Total Capacitive Charge	Qc	VR =800V, Tj=25°C	-	110	-	nC
Capacitance Stored Energy	Ec	VR=800V	-	628	-	µJ

**THERMAL CHARACTERISTICS**

PARAMETER	SYMBOL	VALUE			UNIT
		Min.	Typ.	Max.	
Thermal Resistance from Junction to Case	R θJC	-	0.62 (Per Leg) 0.31 (Device)	-	°C/W

**SILICON CARBIDE (SiC) SCHOTTKY DIODE TO2473L NC1D SERIES**

TYPICAL PERFORMANCE PER LEG (For Reference Only)

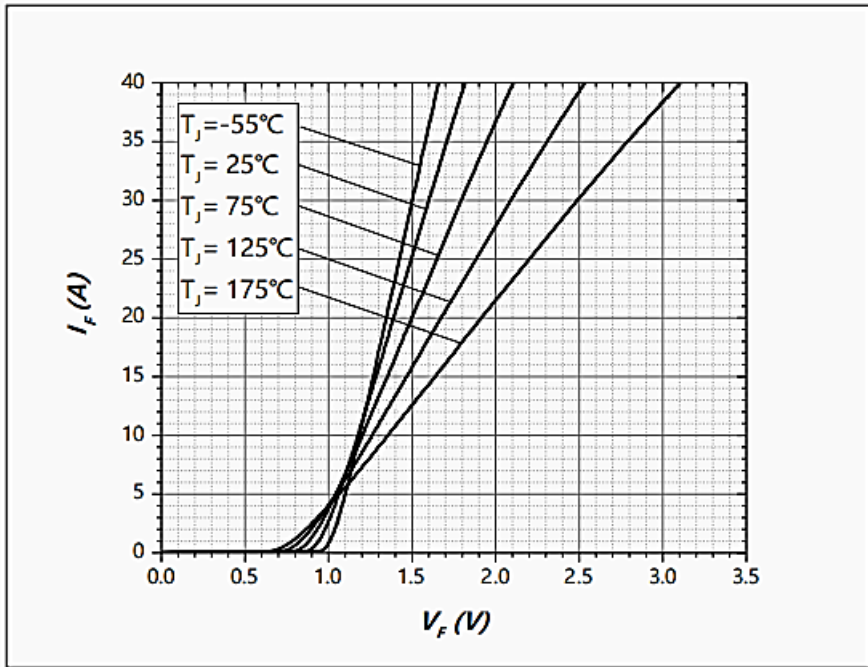

Figure 1. Forward Characteristics

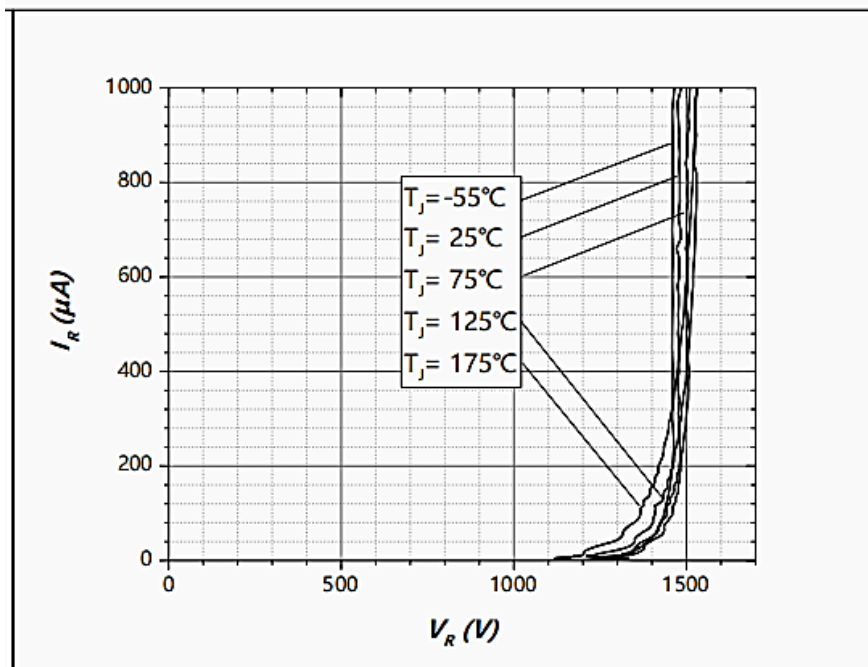

Figure 2. Reverse Characteristics

**SILICON CARBIDE (SiC) SCHOTTKY DIODE TO2473L NC1D SERIES**

**TYPICAL PERFORMANCE PER LEG** (For Reference Only)

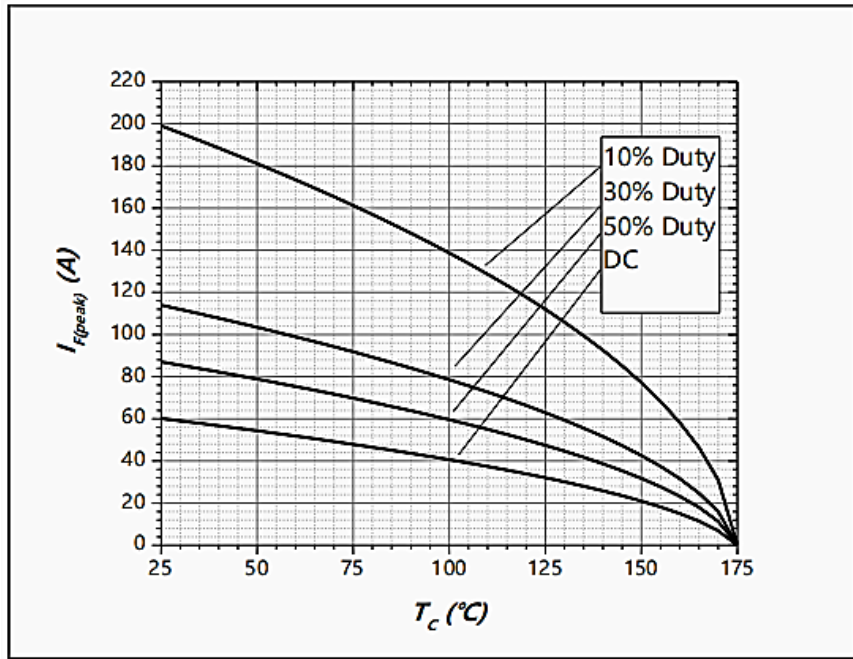

Figure 3. Current Derating

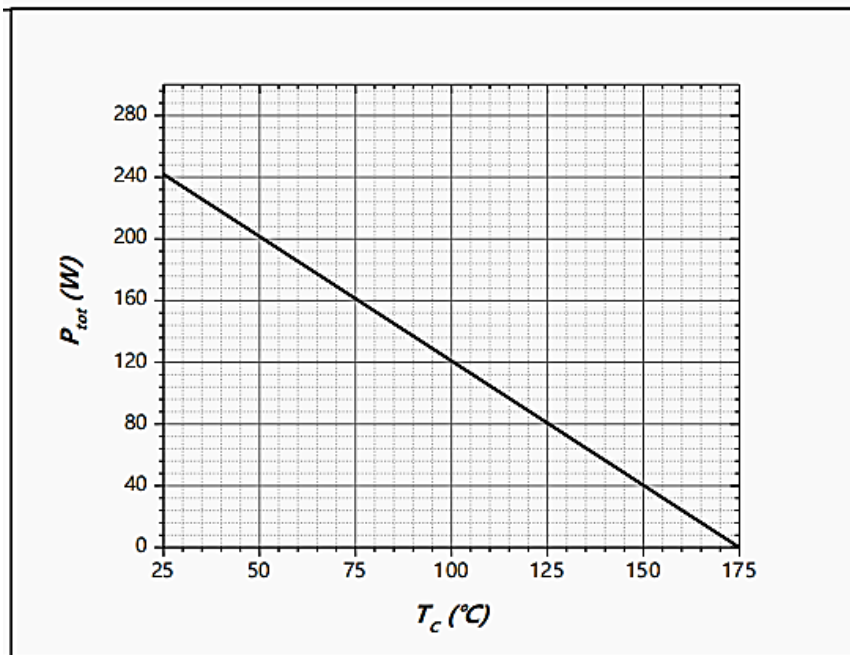

Figure 4. Power Derating



**SILICON CARBIDE (SiC) SCHOTTKY DIODE TO2473L NC1D SERIES**

**TYPICAL PERFORMANCE PER LEG** (For Reference Only)

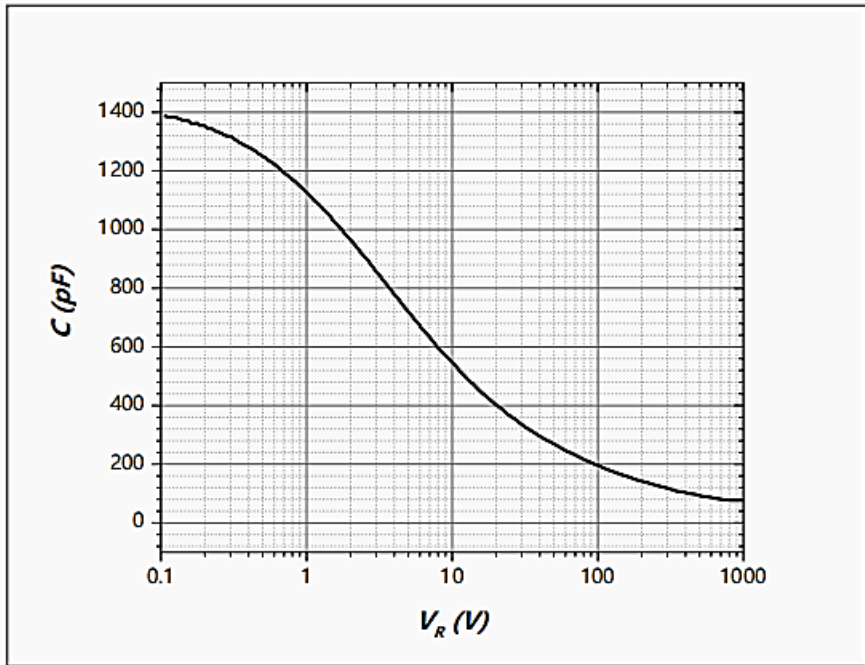

Figure 5. Capacitance vs. Reverse Voltage

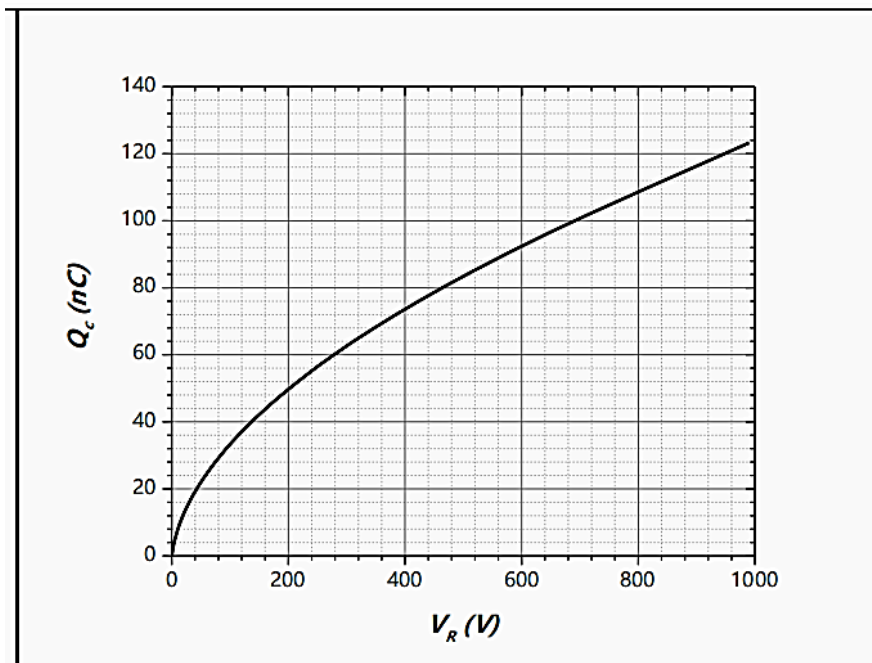

Figure 6. Total Capacitance Charge vs. Reverse Voltage

**SILICON CARBIDE (SiC) SCHOTTKY DIODE TO2473L NC1D SERIES**

TYPICAL PERFORMANCE PER LEG (For Reference Only)

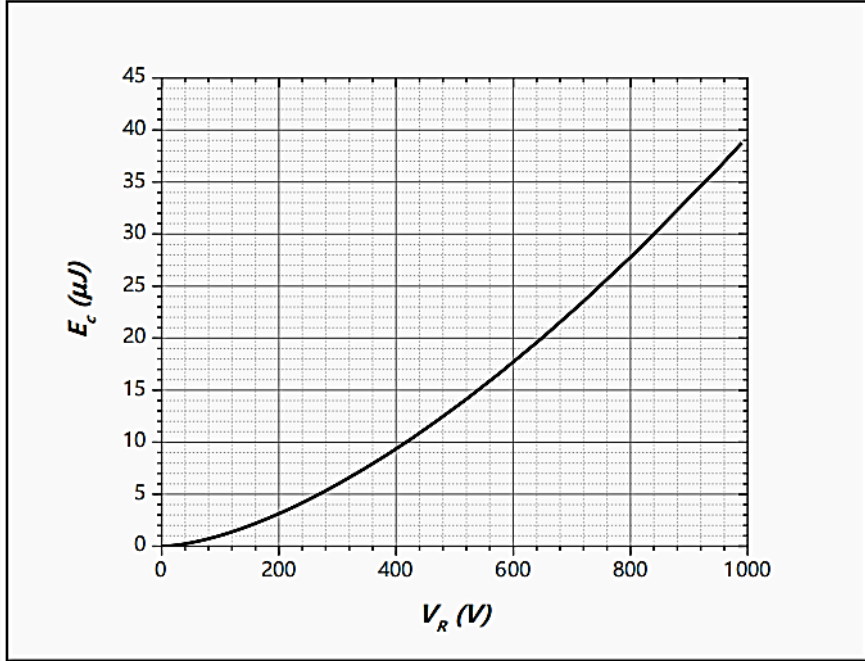

Figure 7. Capacitance Stored Energy

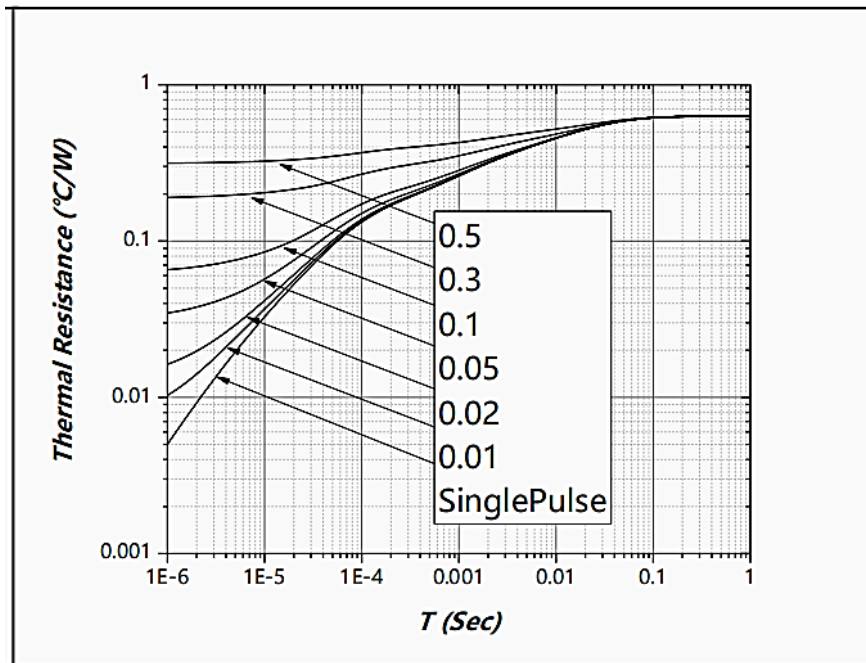

Figure 8. Transient Thermal Impedance

## SILICON CARBIDE (SiC) SCHOTTKY DIODE TO2473L NC1D SERIES

### IMPORTANT NOTES AND DISCLAIMER

1. **ROHS COMPLIANCE:** The levels of RoHS restricted materials in this product are below the maximum concentration values (also referred to as the threshold limits) permitted for such substances, or are used in an exempted application, in accordance with EU RoHS Directive (EU) 2015/863 EC (RoHS3). RoHS Test Report for this product can be obtained at Download Center.
2. **REACH COMPLIANCE:** REACH substances of high concern (SVHCs) information is available for this product. Since the European Chemical Agency (ECHA) has published notice of their intent to frequently revise the SVHC listing for the foreseeable future, REACH Test Report for this product can be obtained at Download Center.
3. All Product parametric performance is indicated in the Electrical Characteristics for the listed herein test conditions, unless otherwise noted. Product performance may not be indicated by the Electrical Characteristics if operated under different conditions.
4. NextGen Component, Inc (*NextGen*) reserves the right to make changes to this document and its products and specifications at any time without notice. Customers should obtain and confirm the latest product information and specifications before final design, purchase or use.
5. *NextGen* makes no warranty, representation or guarantee regarding the suitability of its products for any particular purpose, not does *NextGen* assume any liability for application assistance or customer product design.
6. *NextGen* does not warrant or accept any liability with products which are purchased or used for any unintended or unauthorized application. No license is granted by implication or otherwise under any intellectual property rights of NextGen.
7. *NextGen* products are not authorized for use as critical components in life support devices or systems without express written approval by *NextGen*.
8. *NextGen* requires that customers first obtain an RMA (Returned Merchandise Authorization) number prior to returning any products. Returns must be made within 30 days of the date of invoice, be in the original packaging, unused and like-new condition. At the time of quoting or purchasing, a product may say that it is Non-Cancelable/ Non-Returnable (NCNR). These products are not returnable and not refundable.