



SPECIFICATION SHEET

SPECIFICATION SHEET NO.	R0722- RF01N1R2B250LE	
DATE	Jul. 22, 2024	
REVISION	A4	Updated With Most Recent Data
DESCRIPTION AND MAIN PARAMETRICS	<p>Multilayer Ceramic Chip Capacitors RF0201 (0603 Metric) Series, L0.60*W0.30*H0.30mm, Thickness: 0.33mm Max.</p> <p>Dielectric NP0, Capacitance 1.2pF, Tolerance $\pm 0.1pF$, Rated Voltage 25V</p> <p>Operating Temp. Range -55° C ~+125° C</p> <p>Package in Tape/Reel, 15,000pcs/Reel</p> <p>RoHS/RoHS III compliant</p>	
CUSTOMER		
CUSTOMER PART NO.		
CROSS REF. PART NO.		
ORIGINAL MFG/PART NO.	Aillen/RF0201N1R2B250LE	
PART CODE	RF01N1R2B250LE	

VENDOR APPROVE		
Issued/Checked/Approved		
		
DATE: Jul. 22, 2024		

CUSTOMER APPROVE	
DATE:	

MULTILAYER CERAMIC CHIP CAPACITORS RF SERIES

DESCRIPTION

MLCC consists of a conducting material and electrodes. To manufacture a chip-type SMT and achieve miniaturization, high density and high efficiency, ceramic condensers are used. RF series MLCC is used at high frequencies generally have a small temperature coefficient of capacitance, typical within the $\pm 30\text{ppm}/^\circ\text{C}$ required for NPO (COG) classification and have excellent conductivity internal electrode.

MAIN FEATURE

- REACH/RoHS III Compliant
- High Q and low ESR performance at high frequency
- Ultra low capacitance to 0.1pF
- Can offer high precision tolerance to $\pm 0.05\text{pF}$
- Quality improvement of telephone calls for low power loss and better performance.



APPLICATION

- Mobile phone, WLAN, Base station.
- RF module: Power amplifier, VCO.
- Tuners.

HOW TO ORDER

Please contact us by e-mail sales@NextGenComponents.com and indicate Part code or custom your requirement for your Application.

RFQ

[Request For Quotation](#)

MULTILAYER CERAMIC CHIP CAPACITORS RF SERIES
PART CODE GUIDE

CODE	NAME	KEY SPECIFICATION OPTION
RF	Product code	MLCC RF series for high Q and low ESR
01	Size Code	01: 0201 (0603): L0.60*W0.30mm; 02: 0402 (1005): L1.00*W0.50mm 03: 0603 (1608): L1.60*W0.80mm; 04: 01005 (0402): L0.40*W0.20mm 05: 0805 (2012): L2.00*W1.25mm; 06: 1206 (3216): L3.20*W1.60mm 08: 1808 (4520): L4.50*W2.03mm; 10: 1210 (3225): L3.20*W2.50mm 11: 1111 (2828): L2.79*W2.79mm; 12: 1812 (4532): L4.50*W3.20mm 14: 0505 (1414): L1.40*W1.40mm; 20: 2220 (5750): L5.70*W5.00mm 22: 2225 (5763): L5.70*W6.30mm; 25:1825 (4563):L4.50*W6.30mm
N	Dielectric	N: NP0 (COG); B: X7R;
1R2	Capacitance	Two significant digits followed by number of Zero, The 3rd digit signifies the multiplying factor, and letter R is decimal point. R2: 0.2pF; 1R2: 1.2pF; 9R0: 9.0pF; 330: 33pF; 102: 1000pF
B	Tolerance	A=±0.05pF; B=±0.1pF; C=±0.25pF; D=±0.5pF; F=±1%; G=±2%; J=±5%;
250	Rated Voltage	Two significant digits followed by No. of zeros. "R" is in place of decimal point. e.g.: 6R3=6.3VDC; 101 =100 VDC; 201 =200 VDC; 250=25 VDC; 251=250 VDC 500=50 VDC; 501 =500 VDC;
L	Thickness	V: 0.20±0.02mm; L: 0.30 ±0.03mm; N: 0.50±0.05mm; H: 0.50±0.10mm A: 0.60±0.10mm; S: 0.80±0.07mm; T: 0.80±0.10mm; J: 1.15±0.15mm; G: 1.78mm Max.
E	Package	A: 1Kpcs/Reel; B: 2Kpcs/Reel; C: 3Kpcs/Reel; D: 4Kpcs/Reel; E: 15Kpcs/Reel I: 10Kpcs/Reel; F: others
()	Internal Control	Special or custom specification Code Letter A~Z Or Digits (1-9); Blank: N/A

MULTILAYER CERAMIC CHIP CAPACITORS RF SERIES

DIMENSION (Unit: mm)

Image for reference

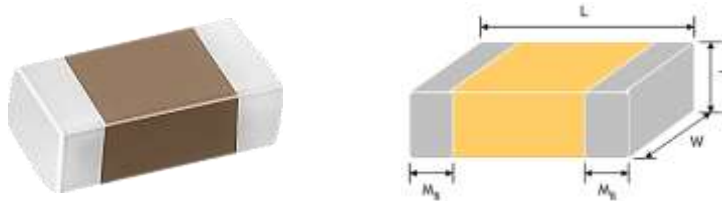

Table 1

Size Code	L	W	T (Symbol)		Remark	M B
01005 (0402)	0.40±0.02	0.20±0.02	0.20±0.02	V	#	0.10+0.03
0201 (0603)	0.60±0.03	0.30±0.03	0.3±0.03	L	#	0.15+0.05
0402 (1005)	1.00±0.05	0.50±0.05	0.50±0.05	N	#	0.25+0.05/-0.10
0603 (1608)	1.60±0.10	0.80±0.10	0.80±0.07	S		0.40±0.15
	1.60+0.15/-0.10	0.80+0.15/-0.10	0.50±0.10	H		
0805 (2012)	2.00±0.15	1.25±0.10	0.60±0.10	A		0.50±0.20
	2.00±0.20	1.25±0.20	0.85±0.10	T		
0505 (1414)	1.40 +0.38/-0.25	1.40±0.38	1.15±0.15	J	#	0.25+0.25/-0.13
1111 (2828)	2.79 +0.51/-0.25	2.79±0.38	≤ 1.78	G	#	0.38±0.25

Reflow soldering only is recommended.

MULTILAYER CERAMIC CHIP CAPACITORS RF SERIES
GENERAL ELECTRONICAL CHARACTERISTICS
Table 2

Dielectric	NPO
Size	01005, 0201, 0402, 0505, 0603, 0805, 1111
Capacitance range*	0.1pF to 1000pF
Capacitance Tolerance	Cap≤5pF: A (±0.05pF), B (±0.1pF), C (±0.25pF) 5pF<Cap<10pF: B (±0.1pF), C (±0.25pF), D (±0.5pF) Cap≥10pF: F (±1%), G (±2%), J (±5%)
Rated Voltage	6.3V, 10V, 25V, 50V, 100V, 200V, 250V, 500V
Q*	01005, 0201, 0402/25V~50V: Cap<30pF:Q≥400+20C; Cap≥30pF:Q≥1000 0402/100V~200V, 0603, 0805, 0505, 1111: Cap<30pF:Q≥800+20C; Cap≥30pF:Q≥1400
Insulation resistance at Ur	≥10GΩ or RxC≥100Ω-F whichever is smaller.
Operating Temperature	-55 ~+125°C
Capacitance change	±30ppm/° C; 0201Cap≥22pF, ±60ppm/° C
Termination	Ni/Sn (lead-free termination)

Note:

- 1) * Measured at the condition of 30~70% related humidity.
- 2) Apply 1.0±0.2Vrms, 1.0MHz±10% for Cap≤1000pF and 1.0±0.2Vrms, 1.0kHz±10% for Cap>1000pF, 25°C at ambient temperature.

MULTILAYER CERAMIC CHIP CAPACITORS RF SERIES

CAPACITANCE RANGE - NP0 DIELECTRIC 01005 SIZES

Table 3-A

Size	01005		Tolerance
	16	25	
RATED VOLTAGE (VDC)			
0.2pF (0R2)	V	V	A, B
0.3pF (0R3)	V	V	A, B
0.4pF (0R4)	V	V	A, B
0.5pF (0R5)	V	V	A, B, C
0.6pF (0R6)	V	V	A, B, C
0.7pF (0R7)	V	V	A, B, C
0.75pF (R75)	V	V	A, B, C
0.8pF (0R8)	V	V	A, B, C
0.9pF (0R9)	V	V	A, B, C
1.0pF (1R0)	V	V	A, B, C
1.2pF (1R2)	V	V	A, B, C
1.5pF (1R5)	V	V	A, B, C
1.8pF (1R8)	V	V	A, B, C
2.0pF (2R0)	V	V	A, B, C
2.2pF (2R2)	V	V	A, B, C
2.7pF (2R7)	V	V	A, B, C
3.0pF (3R0)	V	V	A, B, C
3.3pF (3R3)	V	V	A, B, C
3.9pF (3R9)	V	V	A, B, C
4.0pF (4R0)	V	V	A, B, C
4.7pF (4R7)	V	V	A, B, C
5.0pF (5R0)	V	V	A, B, C
5.6pF (5R6)	V	V	B, C, D
6.0pF (6R0)	V	V	B, C, D
6.8pF (6R8)	V		B, C, D
7.0pF (7R0)	V		B, C, D
8.0pF (8R0)	V		B, C, D
8.2pF (8R2)	V		B, C, D
9.0pF (9R0)	V		B, C, D
10pF (100)	V	V	C, D, G
12pF (120)	V	V	J
15pF (150)	V	V	J
20pF (200)	V	V	J
22pF (220)	V	V	J

MULTILAYER CERAMIC CHIP CAPACITORS RF SERIES

CAPACITANCE RANGE - NPO DIELECTRIC 0201, 0402 SIZES

Table 3-B

Size	0201				0402				Tolerance
RATED VOLTAGE (VDC)	6.3	10	25	50	25	50	100	200	
0.1pF (0R1)	L	L	L	L	N	N	N	N	B
0.2pF (0R2)	L	L	L	L	N	N	N	N	A, B
0.3pF (0R3)	L	L	L	L	N	N	N	N	A, B
0.4pF (0R4)	L	L	L	L	N	N	N	N	A, B
0.5pF (0R5)	L	L	L	L	N	N	N	N	A, B, C
0.6pF (0R6)	L	L	L	L	N	N	N	N	A, B, C
0.7pF (0R7)	L	L	L	L	N	N	N	N	A, B, C
0.75pF (R75)	L	L	L	L	N	N	N	N	A, B, C
0.8pF (0R8)	L	L	L	L	N	N	N	N	A, B, C
0.9pF (0R9)	L	L	L	L	N	N	N	N	A, B, C
1.0pF (1R0)	L	L	L	L	N	N	N	N	A, B, C
1.1pF (1R1)	L	L	L	L	N	N	N	N	A, B, C
1.2pF (1R2)	L	L	L	L	N	N	N	N	A, B, C
1.3pF (1R3)	L	L	L	L	N	N	N	N	A, B, C
1.4pF (1R4)	L	L	L	L	N	N	N	N	A, B, C
1.5pF (1R5)	L	L	L	L	N	N	N	N	A, B, C
1.6pF (1R6)	L	L	L	L	N	N	N	N	A, B, C
1.7pF (1R7)	L	L	L	L	N	N	N	N	A, B, C
1.8pF (1R8)	L	L	L	L	N	N	N	N	A, B, C
1.9pF (1R9)	L	L	L	L	N	N	N	N	A, B, C
2.0pF (2R0)	L	L	L	L	N	N	N	N	A, B, C
2.1pF (2R1)	L	L	L	L	N	N	N	N	A, B, C
2.2pF (2R2)	L	L	L	L	N	N	N	N	A, B, C
2.3pF (2R3)	L	L	L	L	N	N	N	N	A, B, C
2.4pF (2R4)	L	L	L	L	N	N	N	N	A, B, C
2.5pF (2R5)	L	L	L	L	N	N	N	N	A, B, C
2.6pF (2R6)	L	L	L	L	N	N	N	N	A, B, C
2.7pF (2R7)	L	L	L	L	N	N	N	N	A, B, C
2.8pF (2R8)	L	L	L	L	N	N	N	N	A, B, C
2.9pF (2R9)	L	L	L	L	N	N	N	N	A, B, C
3.0pF (3R0)	L	L	L	L	N	N	N	N	A, B, C
3.1pF (3R1)	L	L	L	L	N	N	N	N	A, B, C
3.2pF (3R2)	L	L	L	L	N	N	N	N	A, B, C
3.3pF (3R3)	L	L	L	L	N	N	N	N	A, B, C
3.4pF (3R4)	L	L	L	L	N	N	N	N	A, B, C

MULTILAYER CERAMIC CHIP CAPACITORS RF SERIES

CAPACITANCE RANGE - NPO DIELECTRIC 0201, 0402 SIZES

Table 3-C

Size	0201				0402				Tolerance
RATED VOLTAGE (VDC)	6.3	10	25	50	25	50	100	200	
3.5pF (3R5)	L	L	L	L	N	N	N	N	A, B, C
3.6pF (3R6)	L	L	L	L	N	N	N	N	A, B, C
3.7pF (3R7)	L	L	L	L	N	N	N	N	A, B, C
3.8pF (3R8)	L	L	L	L	N	N	N	N	A, B, C
3.9pF (3R9)	L	L	L	L	N	N	N	N	A, B, C
4.0pF (4R0)	L	L	L	L	N	N	N	N	A, B, C
4.1pF (4R1)	L	L	L	L	N	N	N	N	A, B, C
4.2pF (4R2)	L	L	L	L	N	N	N	N	A, B, C
4.3pF (4R3)	L	L	L	L	N	N	N	N	A, B, C
4.4pF (4R4)	L	L	L	L	N	N	N	N	A, B, C
4.5pF (4R5)	L	L	L	L	N	N	N	N	A, B, C
4.6pF (4R6)	L	L	L	L	N	N	N	N	A, B, C
4.7pF (4R7)	L	L	L	L	N	N	N	N	A, B, C
4.8pF (4R8)	L	L	L	L	N	N	N	N	A, B, C
4.9pF (4R9)	L	L	L	L	N	N	N	N	A, B, C
5.0pF (5R0)	L	L	L	L	N	N	N	N	A, B, C
5.1pF (5R1)	L	L	L	L	N	N	N	N	B, C, D
5.2pF (5R2)	L	L	L	L	N	N	N	N	B, C, D
5.3pF (5R3)	L	L	L	L	N	N	N	N	B, C, D
5.4pF (5R4)	L	L	L	L	N	N	N	N	B, C, D
5.5pF (5R5)	L	L	L	L	N	N	N	N	B, C, D
5.6pF (5R6)	L	L	L	L	N	N	N	N	B, C, D
5.7pF (5R7)	L	L	L	L	N	N	N	N	B, C, D
5.8pF (5R8)	L	L	L	L	N	N	N	N	B, C, D
5.9pF (5R9)	L	L	L	L	N	N	N	N	B, C, D
6.0pF (6R0)	L	L	L	L	N	N	N	N	B, C, D
6.1pF (6R1)	L	L	L	L	N	N	N	N	B, C, D
6.2pF (6R2)	L	L	L	L	N	N	N	N	B, C, D
6.3pF (6R3)	L	L	L	L	N	N	N	N	B, C, D
6.4pF (6R4)	L	L	L	L	N	N	N	N	B, C, D
6.5pF (6R5)	L	L	L	L	N	N	N	N	B, C, D
6.6pF (6R6)	L	L	L	L	N	N	N	N	B, C, D
6.7pF (6R7)	L	L	L	L	N	N	N	N	B, C, D
6.8pF (6R8)	L	L	L	L	N	N	N	N	B, C, D
6.9pF (6R9)	L	L	L	L	N	N	N	N	B, C, D

MULTILAYER CERAMIC CHIP CAPACITORS RF SERIES

CAPACITANCE RANGE - NPO DIELECTRIC 0201, 0402 SIZES

Table 3-D

Size	0201				0402				Tolerance
RATED VOLTAGE (VDC)	6.3	10	25	50	25	50	100	200	
7.0pF (7R0)	L	L	L	L	N	N	N	N	B, C, D
7.1pF (7R1)	L	L	L	L	N	N	N	N	B, C, D
7.2pF (7R2)	L	L	L	L	N	N	N	N	B, C, D
7.3pF (7R3)	L	L	L	L	N	N	N	N	B, C, D
7.4pF (7R4)	L	L	L	L	N	N	N	N	B, C, D
7.5pF (7R5)	L	L	L	L	N	N	N	N	B, C, D
7.6pF (7R6)	L	L	L	L	N	N	N	N	B, C, D
7.7pF (7R7)	L	L	L	L	N	N	N	N	B, C, D
7.8pF (7R8)	L	L	L	L	N	N	N	N	B, C, D
7.9pF (7R9)	L	L	L	L	N	N	N	N	B, C, D
8.0pF (8R0)	L	L	L	L	N	N	N	N	B, C, D
8.1pF (8R1)	L	L	L	L	N	N	N	N	B, C, D
8.2pF (8R2)	L	L	L	L	N	N	N	N	B, C, D
8.3pF (8R3)	L	L	L	L	N	N	N	N	B, C, D
8.4pF (8R4)	L	L	L	L	N	N	N	N	B, C, D
8.5pF (8R5)	L	L	L	L	N	N	N	N	B, C, D
8.6pF (8R6)	L	L	L	L	N	N	N	N	B, C, D
8.7pF (8R7)	L	L	L	L	N	N	N	N	B, C, D
8.8pF (8R8)	L	L	L	L	N	N	N	N	B, C, D
8.9pF (8R9)	L	L	L	L	N	N	N	N	B, C, D
9.0pF (9R0)	L	L	L	L	N	N	N	N	B, C, D
9.1pF (9R1)	L	L	L	L	N	N	N	N	B, C, D
9.2pF (9R2)	L	L	L	L	N	N	N	N	B, C, D
9.3pF (9R3)	L	L	L	L	N	N	N	N	B, C, D
9.4pF (9R4)	L	L	L	L	N	N	N	N	B, C, D
9.5pF (9R5)	L	L	L	L	N	N	N	N	B, C, D
9.6pF (9R6)	L	L	L	L	N	N	N	N	B, C, D
9.7pF (9R7)	L	L	L	L	N	N	N	N	B, C, D
9.8pF (9R8)	L	L	L	L	N	N	N	N	B, C, D
9.9pF (9R9)	L	L	L	L	N	N	N	N	B, C, D
10pF (100)	L	L	L	L	N	N	N	N	F, G, J
11pF (110)	L	L	L	L	N	N	N	N	F, G, J
12pF (120)	L	L	L	L	N	N	N	N	F, G, J
13pF (130)	L	L	L	L	N	N	N	N	F, G, J
15pF (150)	L	L	L	L	N	N	N	N	F, G, J

MULTILAYER CERAMIC CHIP CAPACITORS RF SERIES
CAPACITANCE RANGE - NP0 DIELECTRIC 0201, 0402 SIZES
Table 3-E

Size	0201				0402				Tolerance
RATED VOLTAGE (VDC)	6.3	10	25	50	25	50	100	200	
16pF (160)	L	L	L	L	N	N	N	N	F, G, J
18pF (180)	L	L	L	L	N	N	N	N	F, G, J
20pF (200)	L	L	L	L	N	N	N	N	F, G, J
22pF (220)	L	L	L		N	N	N	N	F, G, J
24pF (240)	L	L	L		N	N	N	N	F, G, J
27pF (270)	L	L	L		N	N	N	N	F, G, J
30pF (300)	L	L	L		N	N	N	N	F, G, J
33pF (330)	L	L	L		N	N	N	N	F, G, J
36pF (360)					N	N	N		F, G, J
39pF (390)					N	N	N		F, G, J
43pF (430)					N	N	N		F, G, J
47pF (470)					N	N	N		F, G, J
56pF (560)					N	N	N		F, G, J
68pF (680)					N	N			F, G, J
82pF (820)					N	N			F, G, J
100pF (101)					N	N			F, G, J

CAPACITANCE RANGE - NP0 DIELECTRIC 0505, 0603, 0805 SIZES
Table 3-F

Size	0505			0603			0805				Tolerance
RATED VOLTAGE (VDC)	50	100	250	50	100	250	50	100	250	500	
0.1pF (0R1)				H	H	H					A, B
0.2pF (0R2)				H	H	H	A	A	A	A	A, B
0.3pF (0R3)				S	S	S	T	T	T	T	A, B
0.4pF (0R4)	J	J	J	S	S	S	T	T	T	T	A, B
0.5pF (0R5)	J	J	J	S	S	S	T	T	T	T	A, B, C
0.6pF (0R6)	J	J	J	S	S	S	T	T	T	T	A, B, C
0.7pF (0R7)	J	J	J	S	S	S	T	T	T	T	A, B, C
0.8pF (0R8)	J	J	J	S	S	S	T	T	T	T	A, B, C
0.9pF (0R9)	J	J	J	S	S	S	T	T	T	T	A, B, C
1.0pF (1R0)	J	J	J	S	S	S	T	T	T	T	A, B, C
1.1pF (1R1)	J	J	J	S	S	S	T	T	T	T	A, B, C
1.2pF (1R2)	J	J	J	S	S	S	T	T	T	T	A, B, C
1.3pF (1R3)	J	J	J	S	S	S	T	T	T	T	A, B, C
1.4pF (1R4)	J	J	J	S	S	S	T	T	T	T	A, B, C

MULTILAYER CERAMIC CHIP CAPACITORS RF SERIES

CAPACITANCE RANGE - NPO DIELECTRIC 0505, 0603, 0805 SIZES

Table 3-G

Size RATED VOLTAGE (VDC)	0505			0603			0805				Tolerance
	50	100	250	50	100	250	50	100	250	500	
1.5pF (1R5)	J	J	J	S	S	S	T	T	T	T	A, B, C
1.6pF (1R6)	J	J	J	S	S	S	T	T	T	T	A, B, C
1.7pF (1R7)	J	J	J	S	S	S	T	T	T	T	A, B, C
1.8pF (1R8)	J	J	J	S	S	S	T	T	T	T	A, B, C
1.9pF (1R9)	J	J	J	S	S	S	T	T	T	T	A, B, C
2.0pF (2R0)	J	J	J	S	S	S	T	T	T	T	A, B, C
2.1pF (2R1)	J	J	J	S	S	S	T	T	T	T	A, B, C
2.2pF (2R2)	J	J	J	S	S	S	T	T	T	T	A, B, C
2.3pF (2R3)	J	J	J	S	S	S	T	T	T	T	A, B, C
2.4pF (2R4)	J	J	J	S	S	S	T	T	T	T	A, B, C
2.5pF (2R5)	J	J	J	S	S	S	T	T	T	T	A, B, C
2.6pF (2R6)	J	J	J	S	S	S	T	T	T	T	A, B, C
2.7pF (2R7)	J	J	J	S	S	S	T	T	T	T	A, B, C
2.8pF (2R8)	J	J	J	S	S	S	T	T	T	T	A, B, C
2.9pF (2R9)	J	J	J	S	S	S	T	T	T	T	A, B, C
3.0pF (3R0)	J	J	J	S	S	S	T	T	T	T	A, B, C
3.1pF (3R1)	J	J	J	S	S	S	T	T	T	T	A, B, C
3.2pF (3R2)	J	J	J	S	S	S	T	T	T	T	A, B, C
3.3pF (3R3)	J	J	J	S	S	S	T	T	T	T	A, B, C
3.4pF (3R4)	J	J	J	S	S	S	T	T	T	T	A, B, C
3.5pF (3R5)	J	J	J	S	S	S	T	T	T	T	A, B, C
3.6pF (3R6)	J	J	J	S	S	S	T	T	T	T	A, B, C
3.7pF (3R7)	J	J	J	S	S	S	T	T	T	T	A, B, C
3.8pF (3R8)	J	J	J	S	S	S	T	T	T	T	A, B, C
3.9pF (3R9)	J	J	J	S	S	S	T	T	T	T	A, B, C
4.0pF (4R0)	J	J	J	S	S	S	T	T	T	T	A, B, C
4.1pF (4R1)	J	J	J	S	S	S	T	T	T	T	A, B, C
4.2pF (4R2)	J	J	J	S	S	S	T	T	T	T	A, B, C
4.3pF (4R3)	J	J	J	S	S	S	T	T	T	T	A, B, C
4.4pF (4R4)	J	J	J	S	S	S	T	T	T	T	A, B, C
4.5pF (4R5)	J	J	J	S	S	S	T	T	T	T	A, B, C
4.6pF (4R6)	J	J	J	S	S	S	T	T	T	T	A, B, C
4.7pF (4R7)	J	J	J	S	S	S	T	T	T	T	A, B, C
4.8pF (4R8)	J	J	J	S	S	S	T	T	T	T	A, B, C

MULTILAYER CERAMIC CHIP CAPACITORS RF SERIES

CAPACITANCE RANGE - NPO DIELECTRIC 0505, 0603, 0805 SIZES

Table 3-H

Size RATED VOLTAGE (VDC)	0505			0603			0805				Tolerance
	50	100	250	50	100	250	50	100	250	500	
4.9pF (4R9)	J	J	J	S	S	S	T	T	T	T	A, B, C
5.0pF (5R0)	J	J	J	S	S	S	T	T	T	T	A, B, C
5.1pF (5R1)	J	J	J	S	S	S	T	T	T	T	B, C, D
5.2pF (5R2)	J	J	J	S	S	S	T	T	T	T	B, C, D
5.3pF (5R3)	J	J	J	S	S	S	T	T	T	T	B, C, D
5.4pF (5R4)	J	J	J	S	S	S	T	T	T	T	B, C, D
5.5pF (5R5)	J	J	J	S	S	S	T	T	T	T	B, C, D
5.6pF (5R6)	J	J	J	S	S	S	T	T	T	T	B, C, D
5.7pF (5R7)	J	J	J	S	S	S	T	T	T	T	B, C, D
5.8pF (5R8)	J	J	J	S	S	S	T	T	T	T	B, C, D
5.9pF (5R9)	J	J	J	S	S	S	T	T	T	T	B, C, D
6.0pF (6R0)	J	J	J	S	S	S	T	T	T	T	B, C, D
6.1pF (6R1)	J	J	J	S	S	S	T	T	T	T	B, C, D
6.2pF (6R2)	J	J	J	S	S	S	T	T	T	T	B, C, D
6.3pF (6R3)	J	J	J	S	S	S	T	T	T	T	B, C, D
6.4pF (6R4)	J	J	J	S	S	S	T	T	T	T	B, C, D
6.5pF (6R5)	J	J	J	S	S	S	T	T	T	T	B, C, D
6.6pF (6R6)	J	J	J	S	S	S	T	T	T	T	B, C, D
6.7pF (6R7)	J	J	J	S	S	S	T	T	T	T	B, C, D
6.8pF (6R8)	J	J	J	S	S	S	T	T	T	T	B, C, D
6.9pF (6R9)	J	J	J	S	S	S	T	T	T	T	B, C, D
7.0pF (7R0)	J	J	J	S	S	S	T	T	T	T	B, C, D
7.1pF (7R1)	J	J	J	S	S	S	T	T	T	T	B, C, D
7.2pF (7R2)	J	J	J	S	S	S	T	T	T	T	B, C, D
7.3pF (7R3)	J	J	J	S	S	S	T	T	T	T	B, C, D
7.4pF (7R4)	J	J	J	S	S	S	T	T	T	T	B, C, D
7.5pF (7R5)	J	J	J	S	S	S	T	T	T	T	B, C, D
7.6pF (7R6)	J	J	J	S	S	S	T	T	T	T	B, C, D
7.7pF (7R7)	J	J	J	S	S	S	T	T	T	T	B, C, D
7.8pF (7R8)	J	J	J	S	S	S	T	T	T	T	B, C, D
7.9pF (7R9)	J	J	J	S	S	S	T	T	T	T	B, C, D
8.0pF (8R0)	J	J	J	S	S	S	T	T	T	T	B, C, D
8.1pF (8R1)	J	J	J	S	S	S	T	T	T	T	B, C, D
8.2pF (8R2)	J	J	J	S	S	S	T	T	T	T	B, C, D

MULTILAYER CERAMIC CHIP CAPACITORS RF SERIES

CAPACITANCE RANGE - NPO DIELECTRIC 0505, 0603, 0805 SIZES

Table 3-1

Size	0505			0603			0805				Tolerance
	RATED VOLTAGE (VDC)	50	100	250	50	100	250	50	100	250	
8.3pF (8R3)	J	J	J	S	S	S	T	T	T	T	B, C, D
8.4pF (8R4)	J	J	J	S	S	S	T	T	T	T	B, C, D
8.5pF (8R5)	J	J	J	S	S	S	T	T	T	T	B, C, D
8.6pF (8R6)	J	J	J	S	S	S	T	T	T	T	B, C, D
8.7pF (8R7)	J	J	J	S	S	S	T	T	T	T	B, C, D
8.8pF (8R8)	J	J	J	S	S	S	T	T	T	T	B, C, D
8.9pF (8R9)	J	J	J	S	S	S	T	T	T	T	B, C, D
9.0pF (9R0)	J	J	J	S	S	S	T	T	T	T	B, C, D
9.1pF (9R1)	J	J	J	S	S	S	T	T	T	T	B, C, D
9.2pF (9R2)	J	J	J	S	S	S	T	T	T	T	B, C, D
9.3pF (9R3)	J	J	J	S	S	S	T	T	T	T	B, C, D
9.4pF (9R4)	J	J	J	S	S	S	T	T	T	T	B, C, D
9.5pF (9R5)	J	J	J	S	S	S	T	T	T	T	B, C, D
9.6pF (9R6)	J	J	J	S	S	S	T	T	T	T	B, C, D
9.7pF (9R7)	J	J	J	S	S	S	T	T	T	T	B, C, D
9.8pF (9R8)	J	J	J	S	S	S	T	T	T	T	B, C, D
9.9pF (9R9)	J	J	J	S	S	S	T	T	T	T	B, C, D
10pF (100)	J	J	J	S	S	S	T	T	T	T	F, G, J
11pF (110)	J	J	J	S	S	S	T	T	T	T	F, G, J
12pF (120)	J	J	J	S	S	S	T	T	T	T	F, G, J
13pF (130)	J	J	J	S	S	S	T	T	T	T	F, G, J
15pF (150)	J	J	J	S	S	S	T	T	T	T	F, G, J
16pF (160)	J	J	J	S	S	S	T	T	T	T	F, G, J
18pF (180)	J	J	J	S	S	S	T	T	T	T	F, G, J
20pF (200)	J	J	J	S	S	S	T	T	T	T	F, G, J
22pF (220)	J	J	J	S	S	S	T	T	T	T	F, G, J
24pF (240)	J	J	J	S	S	S	T	T	T	T	F, G, J
27pF (270)	J	J	J	S	S	S	T	T	T	T	F, G, J
30pF (300)	J	J	J	S	S	S	T	T	T	T	F, G, J
33pF (330)	J	J	J	S	S	S	T	T	T	T	F, G, J
36pF (360)	J	J	J	S	S	S	T	T	T	T	F, G, J
39pF (390)	J	J	J	S	S	S	T	T	T	T	F, G, J
43pF (430)	J	J	J	S	S	S	T	T	T	T	F, G, J
47pF (470)	J	J	J	S	S	S	T	T	T	T	F, G, J

MULTILAYER CERAMIC CHIP CAPACITORS RF SERIES
CAPACITANCE RANGE - NP0 DIELECTRIC 0505, 0603, 0805 SIZES
Table 3-J

Size	0505			0603			0805				Tolerance
	50	100	250	50	100	250	50	100	250	500	
56pF (560)	J	J	J	S	S	S	T	T	T	T	F, G, J
68pF (680)	J	J	J	S	S	S	T	T	T	T	F, G, J
82pF (820)	J	J	J	S	S	S	T	T	T		F, G, J
100pF (101)	J	J	J	S	S	S	T	T	T		F, G, J
120pF (120)							T	T	T		F, G, J
150pF (150)							T	T	T		F, G, J
180pF (180)							T	T	T		F, G, J
220pF (221)							T	T	T		F, G, J

CAPACITANCE RANGE - NP0 DIELECTRIC 1111 SIZES
Table 3-K

Size	1111					Tolerance
	50	100	200	250	500	
2.0pF (2R0)	G	G	G	G	G	A, B, C
2.2pF (2R2)	G	G	G	G	G	A, B, C
2.7pF (2R7)	G	G	G	G	G	A, B, C
3.3pF (3R3)	G	G	G	G	G	A, B, C
3.9pF (3R9)	G	G	G	G	G	A, B, C
4.7pF (4R7)	G	G	G	G	G	A, B, C
5.6pF (5R6)	G	G	G	G	G	B, C, D
6.8pF (6R8)	G	G	G	G	G	B, C, D
8.2pF (8R2)	G	G	G	G	G	B, C, D
10pF (100)	G	G	G	G	G	F, G, J
12pF (120)	G	G	G	G	G	F, G, J
15pF (150)	G	G	G	G	G	F, G, J
18pF (180)	G	G	G	G	G	F, G, J
22pF (220)	G	G	G	G	G	F, G, J
27pF (270)	G	G	G	G	G	F, G, J
33pF (330)	G	G	G	G	G	F, G, J
39pF (390)	G	G	G	G	G	F, G, J
47pF (470)	G	G	G	G	G	F, G, J
56pF (560)	G	G	G	G	G	F, G, J
68pF (680)	G	G	G	G	G	F, G, J
82pF (820)	G	G	G	G	G	F, G, J
100pF (101)	G	G	G	G	G	F, G, J

MULTILAYER CERAMIC CHIP CAPACITORS RF SERIES

CAPACITANCE RANGE - NP0 DIELECTRIC 1111 SIZES

Table 3-L

Size	1111					Tolerance
RATED VOLTAGE (VDC)	50	100	200	250	500	
120pF (121)	G	G	G	G	G	F, G, J
150pF (151)	G	G	G	G	G	F, G, J
180pF (181)	G	G	G	G	G	F, G, J
220pF (221)	G	G	G	G	G	F, G, J
270pF (271)	G	G	G	G	G	F, G, J
330pF (331)	G	G	G	G	G	F, G, J
390pF (391)	G	G	G	G	G	F, G, J
470pF (471)	G	G	G	G	G	F, G, J
560pF (561)	G	G	G	G	G	F, G, J
680pF (681)	G	G	G	G	G	F, G, J
820pF (821)	G	G	G	G	G	F, G, J
1000pF (102)	G	G	G	G	G	F, G, J

MULTILAYER CERAMIC CHIP CAPACITORS RF SERIES

ELECTRICAL CHARACTERISTICS

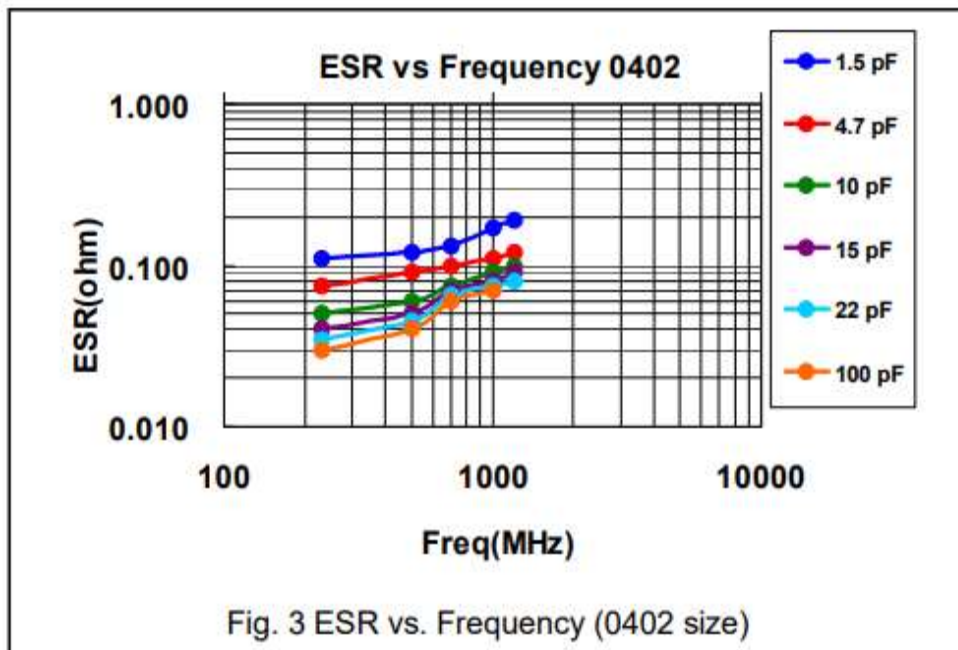
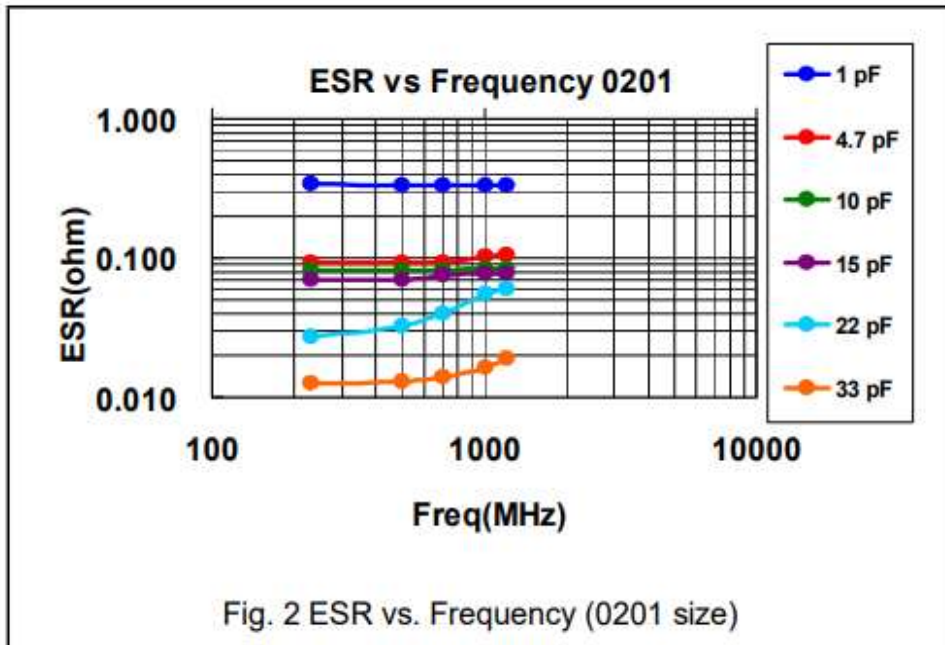

MULTILAYER CERAMIC CHIP CAPACITORS RF SERIES

ELECTRICAL CHARACTERISTICS

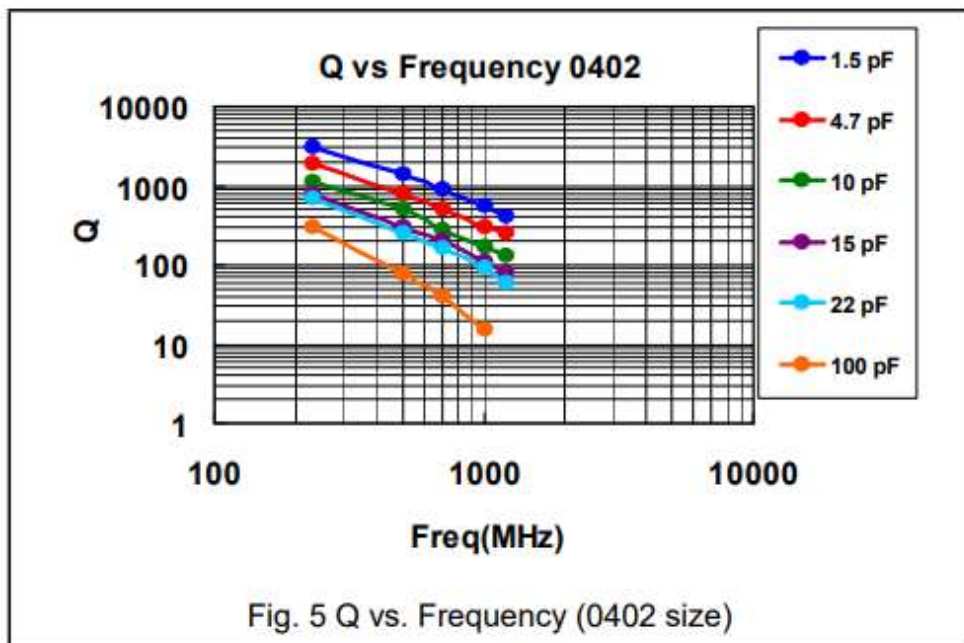
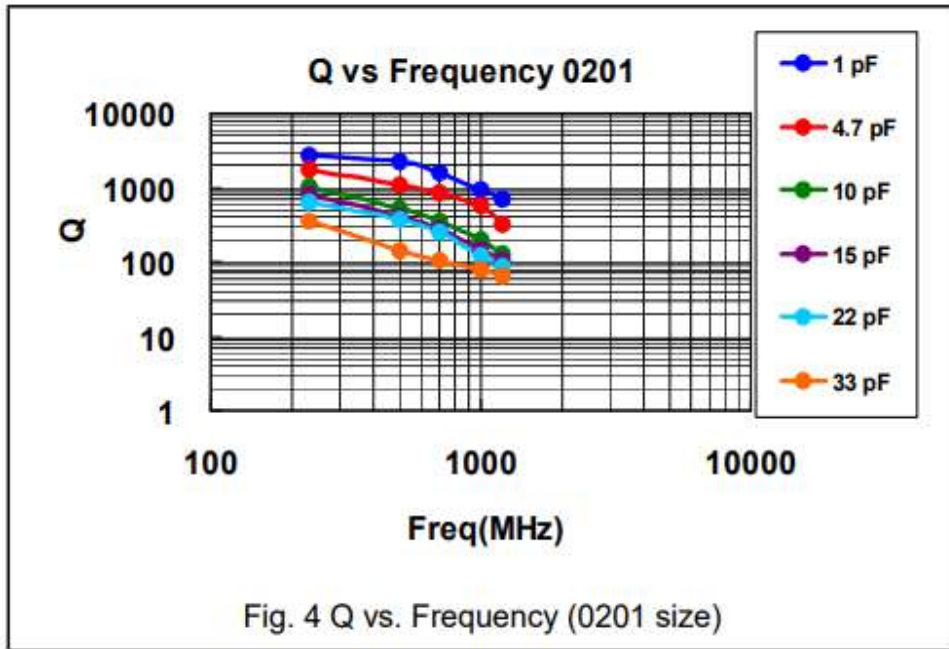

MULTILAYER CERAMIC CHIP CAPACITORS RF SERIES

ELECTRICAL CHARACTERISTICS

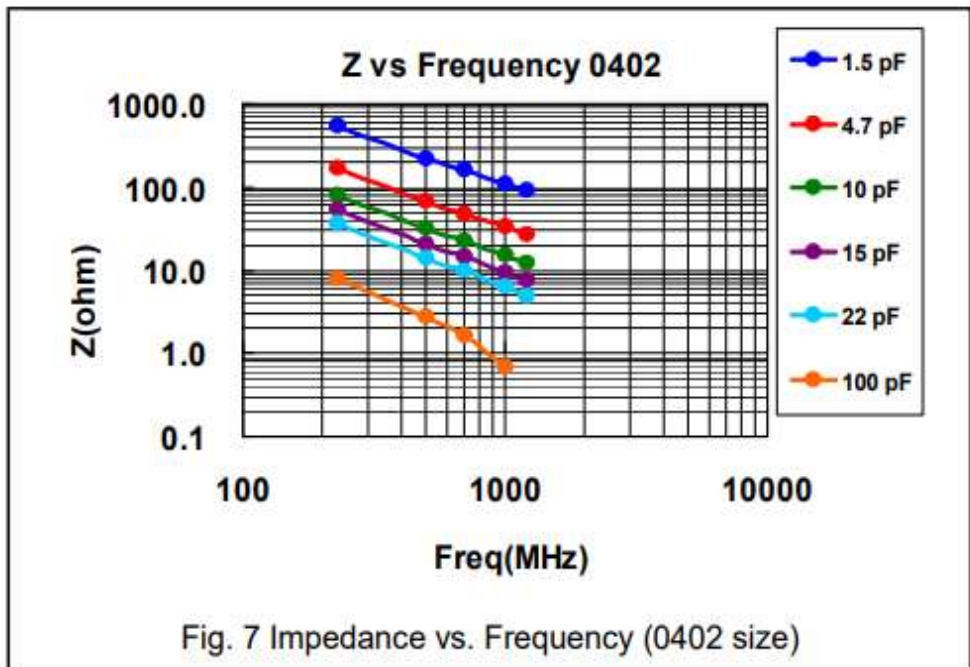
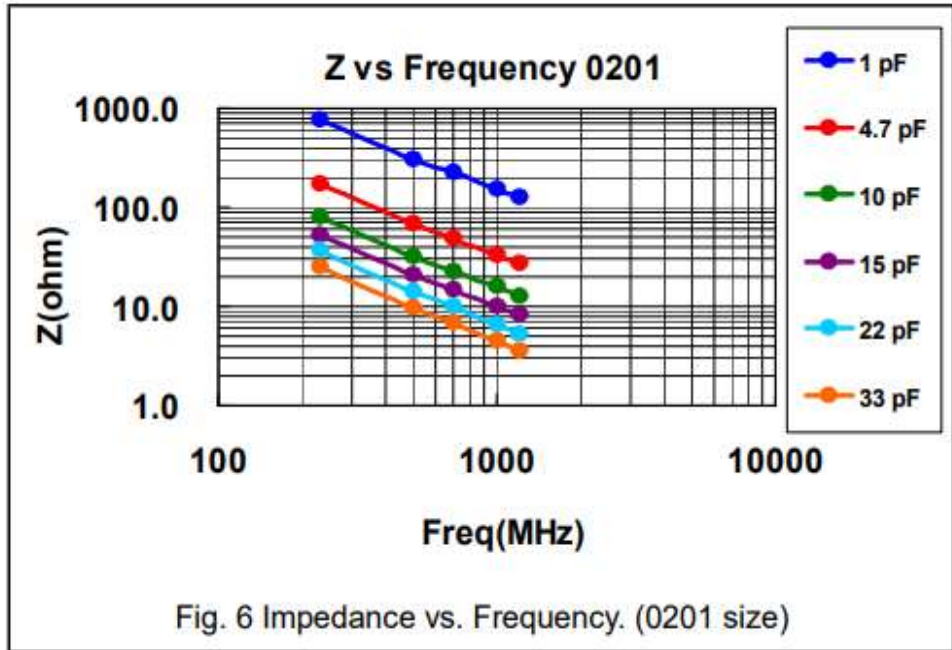

MULTILAYER CERAMIC CHIP CAPACITORS RF SERIES

ELECTRICAL CHARACTERISTICS

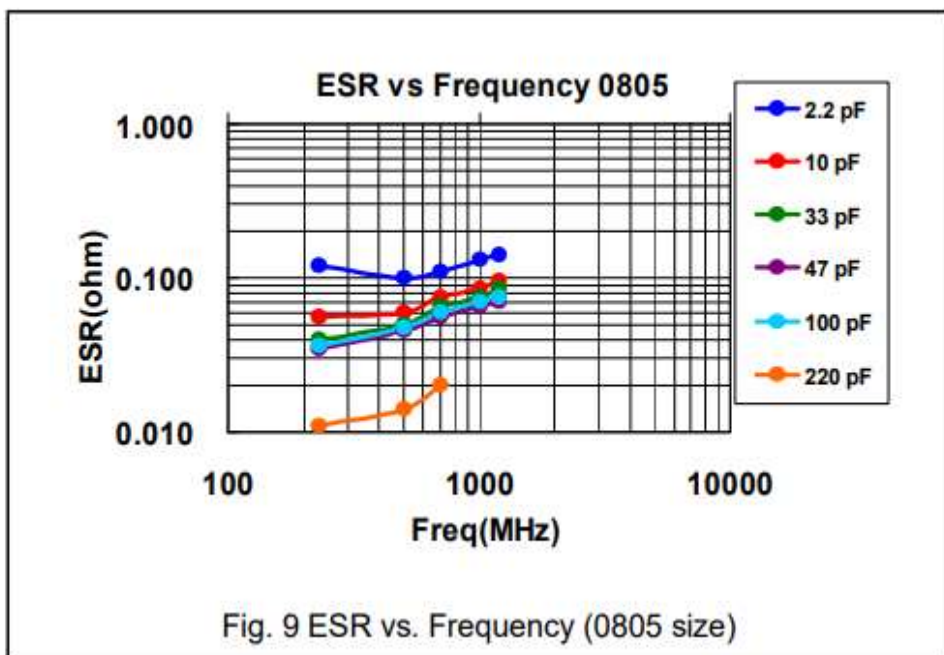
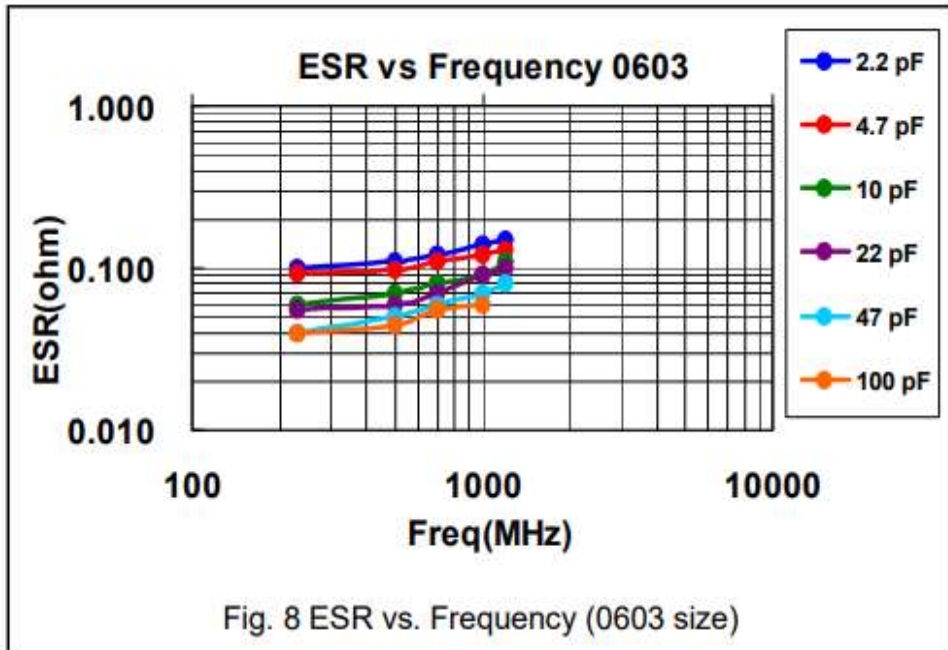

MULTILAYER CERAMIC CHIP CAPACITORS RF SERIES

ELECTRICAL CHARACTERISTICS

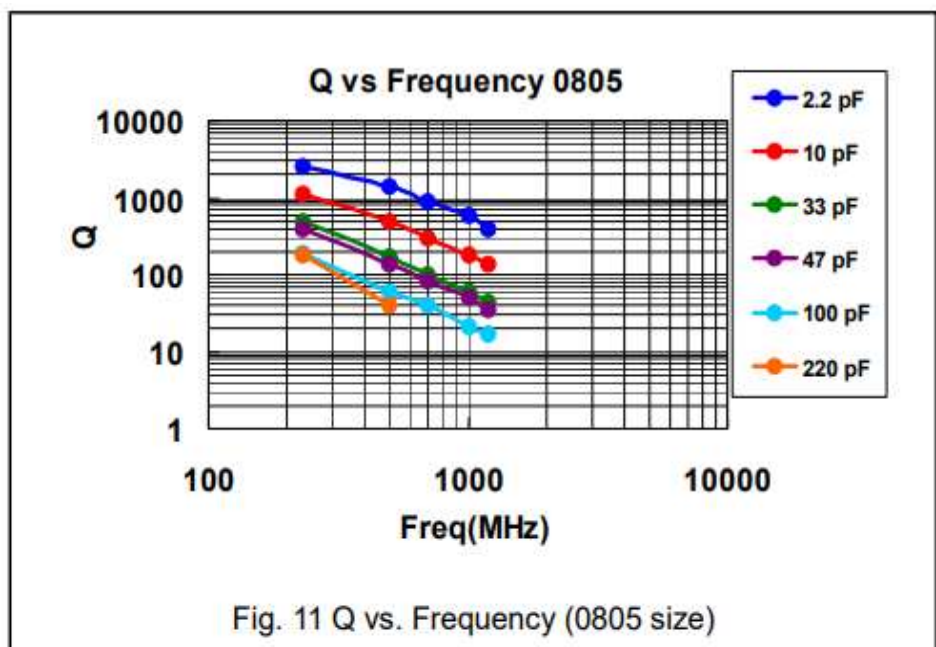
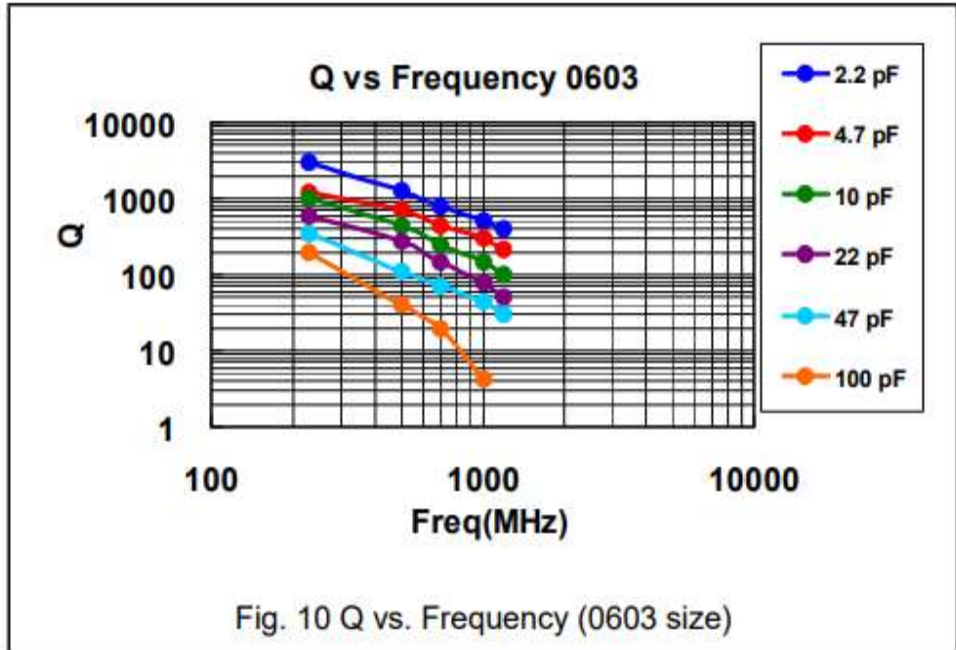

MULTILAYER CERAMIC CHIP CAPACITORS RF SERIES

ELECTRICAL CHARACTERISTICS

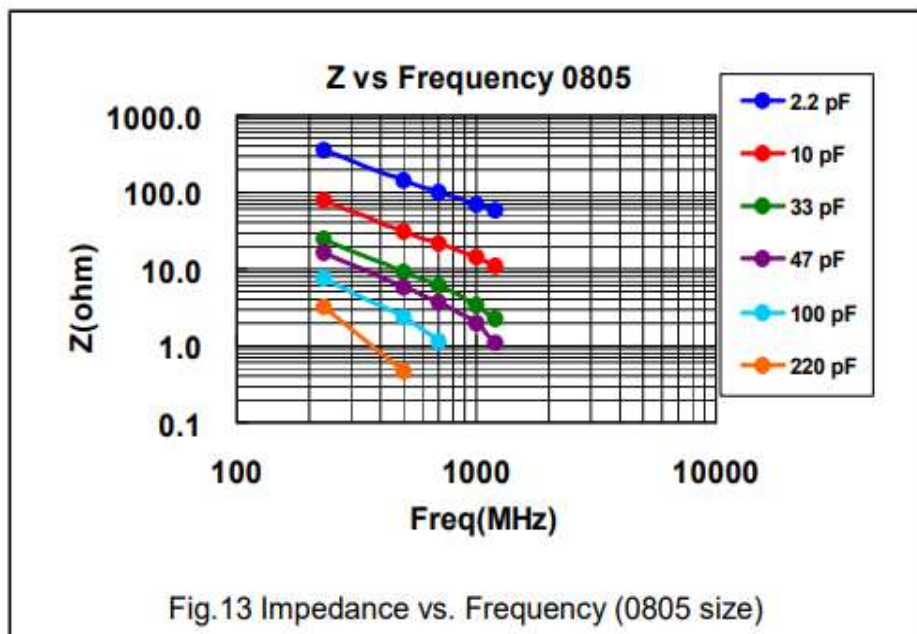
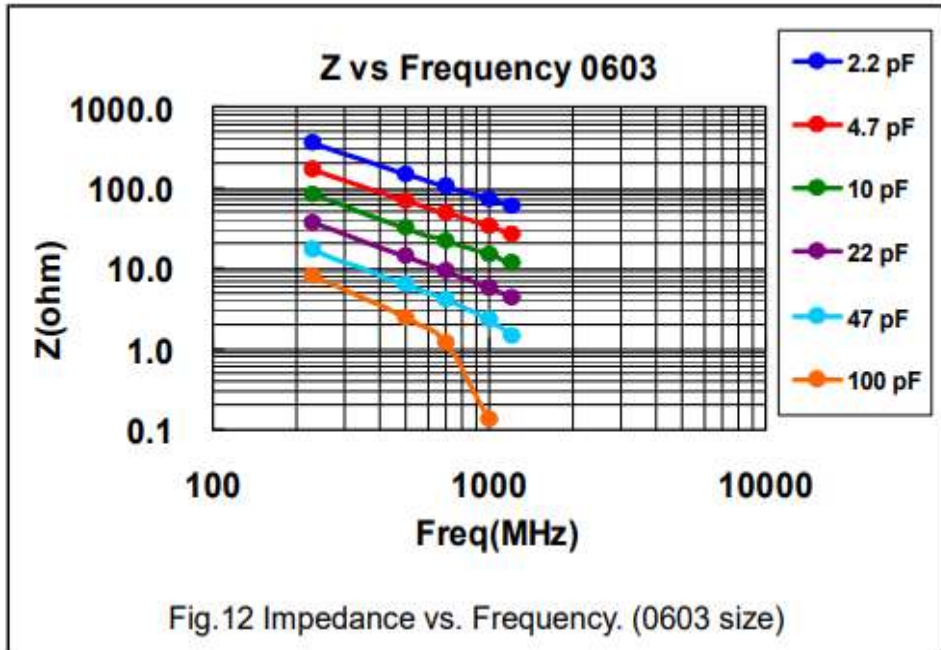

MULTILAYER CERAMIC CHIP CAPACITORS RF SERIES

ELECTRICAL CHARACTERISTICS

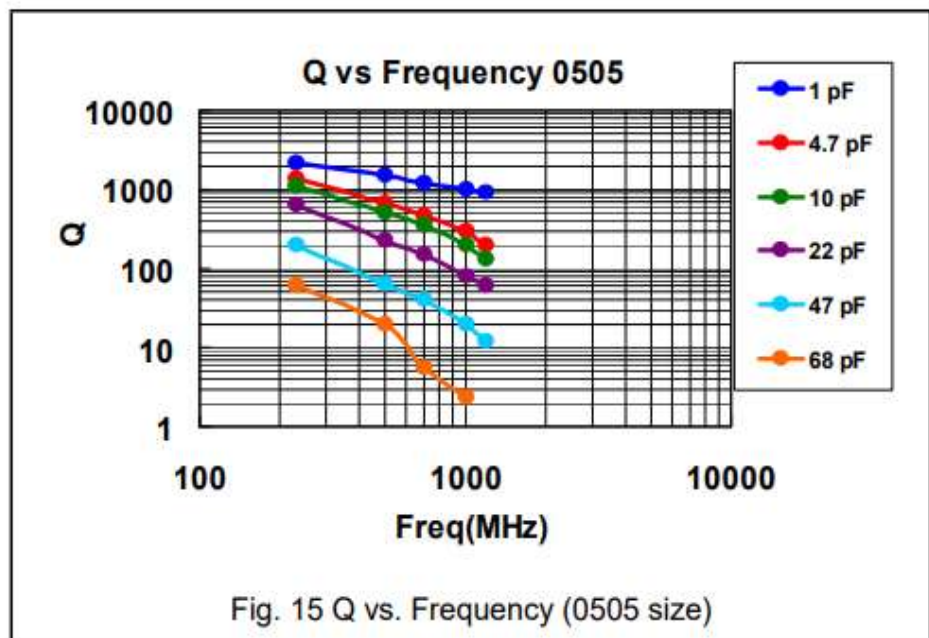
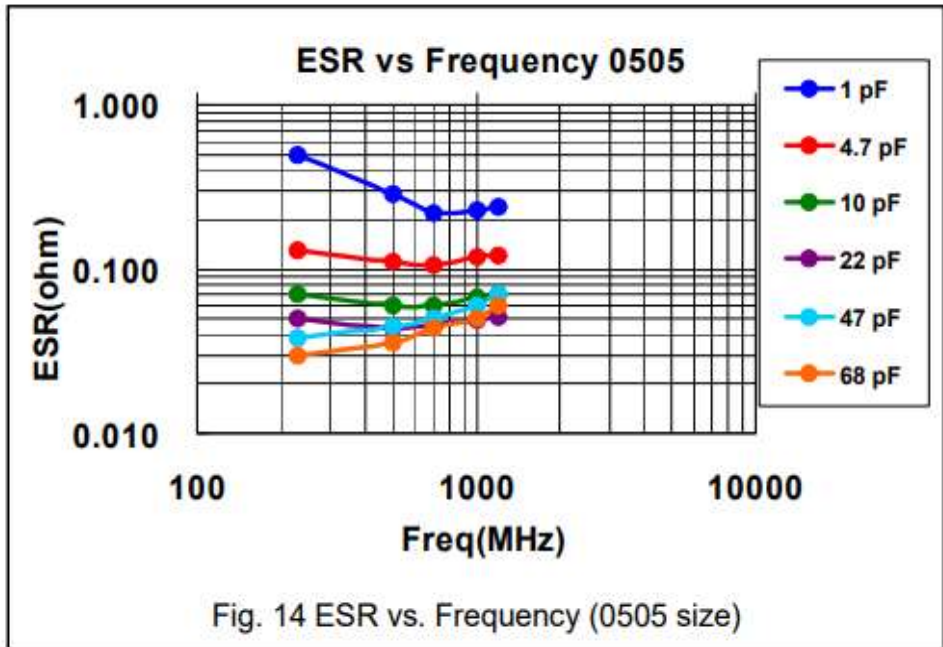

MULTILAYER CERAMIC CHIP CAPACITORS RF SERIES

ELECTRICAL CHARACTERISTICS

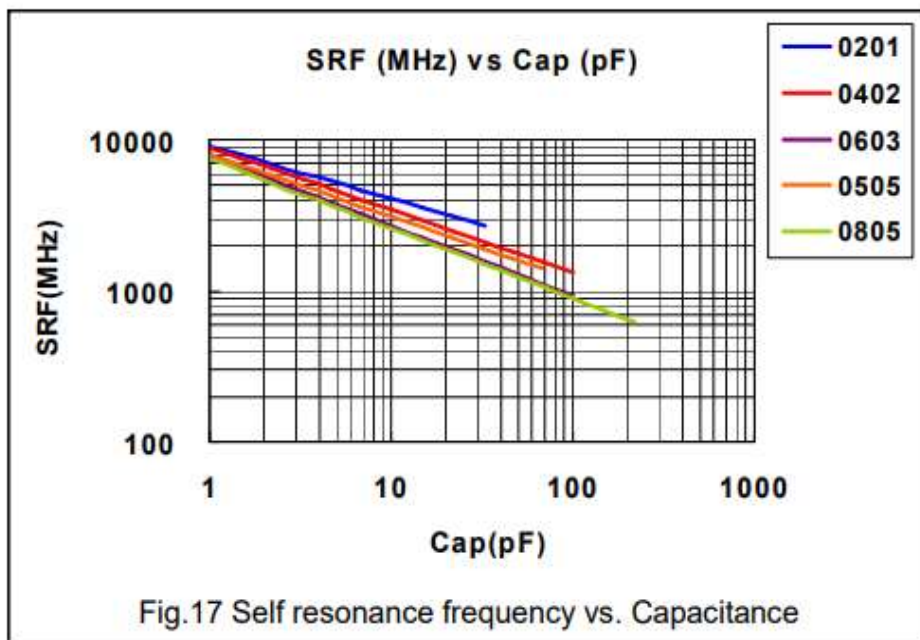
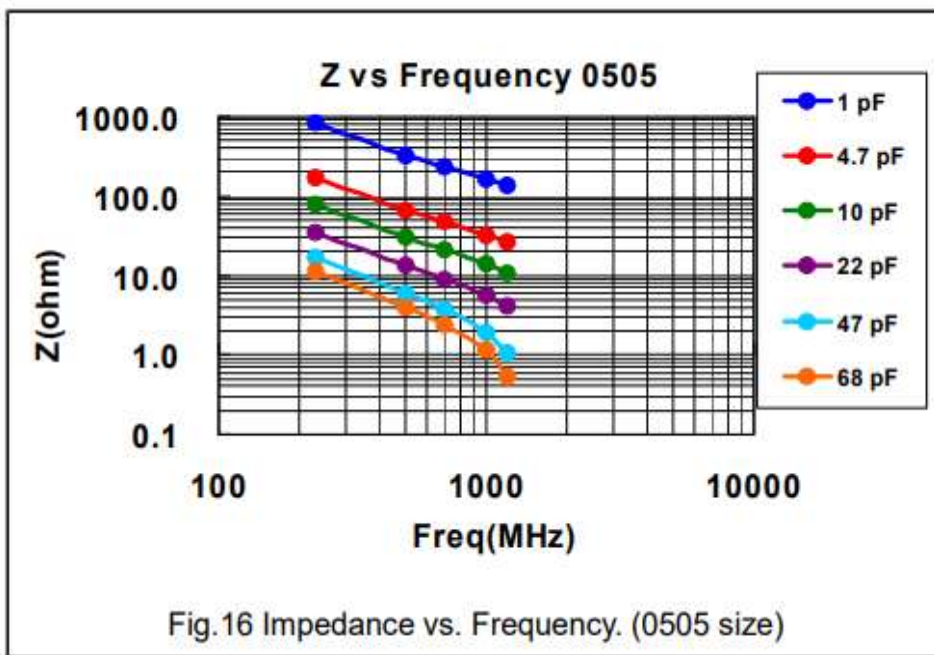

MULTILAYER CERAMIC CHIP CAPACITORS RF SERIES
Temperature Cycle– Test Condition
Table 4

Step	Temp. (°C)	Time (min.)
1	Min. operating temp. +0/-3	30±3
2	Room temp.	2~3
3	Max. operating temp. +3/-0	30±3
4	Room temp.	2~3

ESR– Requirements
Table 5

01005	0505
0.2pF≤Cap≤1pF:< 700mΩ/pF	0.4pF≤Cap<1.0pF: < 1500mΩ
1pF<Cap≤2pF:< 600mΩ	1.0pF≤Cap<10pF:< 250mΩ
2pF<Cap≤5pF:< 500mΩ	10pF≤Cap≤100pF: < 200mΩ
5pF<Cap≤10pF:< 300mΩ	
10pF<Cap≤22pF:< 350mΩ	

0201	0402
0.1pF≤Cap≤1pF:< 350mΩ/Pf	0.1pF≤Cap≤1pF:< 350mΩ/pF
1pF<Cap≤5pF:< 300mΩ	1pF<Cap≤5pF:< 300mΩ
5pF<Cap≤22pF:< 250mΩ	5pF<Cap≤100pF:< 250mΩ
22pF≤Cap≤33pF: < 300mΩ	

0603	0805
0.3pF≤Cap≤1pF:< 1500mΩ	0.3pF≤Cap≤1pF: < 1500mΩ
1pF<Cap≤10pF:< 250mΩ	1pF<Cap≤10pF: < 250mΩ
10pF<Cap≤100pF:< 200mΩ	Cap>10pF: < 200mΩ

MULTILAYER CERAMIC CHIP CAPACITORS RF SERIES
RELIABILITY TEST CONDITIONS AND REQUIREMENTS

Item	Test Conditions	Requirements
Visual and Mechanical	-----	<ul style="list-style-type: none"> * No remarkable defect. * Dimensions to conform to individual specification sheet.
Capacitance	$1.0 \pm 0.2V_{rms}$, $1MHz \pm 10\%$ At 25° C ambient temperature.	* Shall not exceed the limits given in the detailed spec.
Q/ D.F. (Dissipation Factor)		<ul style="list-style-type: none"> * 01005, 0201, 0402/25V~50V: Cap<30pF, Q≥400+20C; Cap≥30pF, Q≥1000 * 0402/100V~200V, 0603, 0805, 0505, 1111: Cap<30pF: Q≥800+20C; Cap≥30pF: Q≥1400
Dielectric Strength	*To apply voltage: $\leq 100V$: 250% of rated voltage. 200V ~ 300V : 200% of rated voltage. 500V ~ 999V : 150% of rated voltage. 1000V ~ 3000V : 120% of rated voltage. 4000V : 110% of rated voltage. *Duration: 1 to 5 sec. *Charge & discharge current less than 50mA.	* No evidence of damage or flash over during test.
Insulation Resistance	$\leq 100V$: To apply rated voltage for max. 120 sec. $\geq 200V$: To apply rated voltage (500V max.) for 60 sec.	$\geq 10G\Omega$ or $RxC \geq 100\Omega \cdot F$ whichever is smaller
Temperature Coefficient	With no electrical load. Operating temperature: -55~125° C at 25° C	*Capacitance change: within $\pm 30ppm/^{\circ} C$; 0201Cap $\geq 22pF$, within $\pm 60ppm/^{\circ} C$
Temperature Cycle	*Conduct the five cycles according to the temperatures and time See <Table 4> * Cap. / DF(Q) / I.R. Measurement to be made after de-aging at 150° C for 1hr then set for 24 ± 2 hrs at room temp.	<ul style="list-style-type: none"> * No remarkable damage. * Cap change: within $\pm 2.5\%$ or $\pm 0.25pF$ whichever is larger. * Q/D.F., I.R. and dielectric strength: To meet initial requirements.

MULTILAYER CERAMIC CHIP CAPACITORS RF SERIES
RELIABILITY TEST CONDITIONS AND REQUIREMENTS

Item	Test Conditions	Requirements
Adhesive Strength of Termination	*Pressurizing force: 01005: 1N 0201: 2N 0402 to 0603: 5N >0603: 10N * Test time: 10 ± 1 sec.	* No remarkable damage or removal of the terminations.
Vibration Resistance	* Vibration frequency: 10~55 Hz/min. * Total amplitude: 1.5mm * Test time: 6 hrs. (Two hrs each in three mutually perpendicular directions.) *Cap./DF(Q) Measurement to be made after de-aging at 150° C for 1hr then set for 24 ± 2 hrs at room temp.	*No remarkable damage. * Cap change and Q/D.F.: To meet initial spec.
Solderability	* Solder temperature: $235 \pm 5^{\circ}$ C * Dipping time: 2 ± 0.5 sec.	95% min. coverage of all metalized area.
Bending Test	*The middle part of substrate shall be pressurized by means of the pressurizing rod at a rate of about 1 mm per second until the deflection becomes 1 mm and then the pressure shall be maintained for 5 ± 1 sec. * Measurement to be made after keeping at room temp. for 24 ± 2 hrs.	*No remarkable damage. * Cap change: within $\pm 5.0\%$ or $\pm 0.5\text{pF}$ whichever is larger. (This capacitance change means the change of capacitance under specified flexure of substrate from the capacitance measured before the test.)
Resistance to Soldering Heat	* Solder temperature: $260 \pm 5^{\circ}$ C * Dipping time: 10 ± 1 sec *Preheating: 120 to 150° C for 1 minute before immerse the capacitor in a eutectic solder. *Cap. / DF(Q) / I.R. Measurement to be made after de-aging at 150° C for 1hr then set for 24 ± 2 hrs at room temp.	* No remarkable damage. *Cap change: within $\pm 2.5\%$ or $\pm 0.25\text{pF}$ whichever is larger. * Q/D.F., I.R. and dielectric strength: To meet initial requirements. * 25% max. leaching on each edge.

MULTILAYER CERAMIC CHIP CAPACITORS RF SERIES
RELIABILITY TEST CONDITIONS AND REQUIREMENTS

Item	Test Conditions	Requirements
Humidity (Damp Heat) Steady State	<ul style="list-style-type: none"> *Test temp.: $40 \pm 2^{\circ}$ C * Humidity: 90~95% RH * Test time: 500+24/-0hrs. * Cap. / DF(Q) / I.R. Measurement to be made after de-aging at 150° C for 1hr then set for 24 ± 2 hrs at room temp. 	<ul style="list-style-type: none"> * No remarkable damage. * Cap change: within $\pm 5.0\%$ or $\pm 0.5\text{pF}$ whichever is larger. *Q/D.F. value: Cap$\geq 30\text{pF}$, Q≥ 350; 10pF\leqCap$< 30\text{pF}$, Q$\geq 275+2.5C$ Cap$< 10\text{pF}$, Q$\geq 200+10C$ * I.R.: $\geq 1G\Omega$.
Humidity (Damp Heat) Load	<ul style="list-style-type: none"> *Test temp.: $40 \pm 2^{\circ}$ C * Humidity: 90~95%RH * Test time: 500+24/-0 hrs. *To apply voltage: rated voltage (MAX. 500V) * Cap. / DF(Q) / I.R. Measurement to be made after de-aging at 150° C for 1hr then set for 24 ± 2 hrs at room temp. 	<ul style="list-style-type: none"> * No remarkable damage. * Cap change: within $\pm 7.5\%$ or $\pm 0.75\text{pF}$ whichever is larger. *Q/D.F. value: Cap$\geq 30\text{pF}$, Q≥ 200; Cap$< 30\text{pF}$, Cap$\geq 100+10/3C$ * I.R.: $\geq 500M\Omega$.
High Temperature Load (Endurance)	<ul style="list-style-type: none"> * Test temp.: $125 \pm 3^{\circ}$ C * To apply voltage: (1) $10V \leq U_r < 500V$: 200% of rated voltage. (2) $\leq 6.3V$ or $500V$: 150% of rated voltage. (3) $U_r \geq 630V$: 120% of rated voltage. * Test time: 1000+24/-0 hrs. * Cap. / DF(Q) / I.R. Measurement to be made after de-aging at 150° C for 1hr then set for 24 ± 2 hrs at room temp 	<ul style="list-style-type: none"> * No remarkable damage. * Cap change: within $\pm 3.0\%$ or $\pm 0.3\text{pF}$ whichever is larger. * Q/D.F. value: Cap$\geq 30\text{pF}$, Q≥ 350 10pF\leqCap$< 30\text{pF}$, Q$\geq 275+2.5C$ Cap$< 10\text{pF}$, Q$\geq 200+10C$ * I.R.: $\geq 1G\Omega$.
ESR	<p>The ESR should be measured at room temperature and tested at frequency 1 ± 0.1 GHz.</p> <p>The ESR should be measured at room temperature and tested at frequency 500 ± 50 MHz.</p>	See <Table 5>

MULTILAYER CERAMIC CHIP CAPACITORS RF SERIES

RECOMMENDED PROFILE CONDITIONS

The lead-free termination MLCCs are not only to be used on SMT against lead-free solder paste, but also suitable against lead-containing solder paste.

If the optimized solder joint is requested, increasing soldering time, temperature and concentration of N2 within oven are recommended.

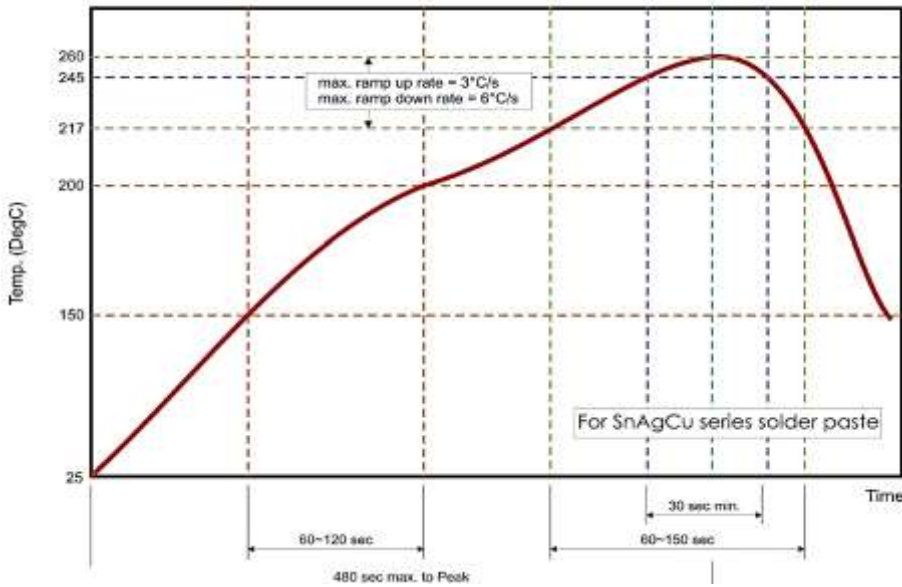

Reflow Soldering Profile For SMT Process with SnAgCu series Solder Paste

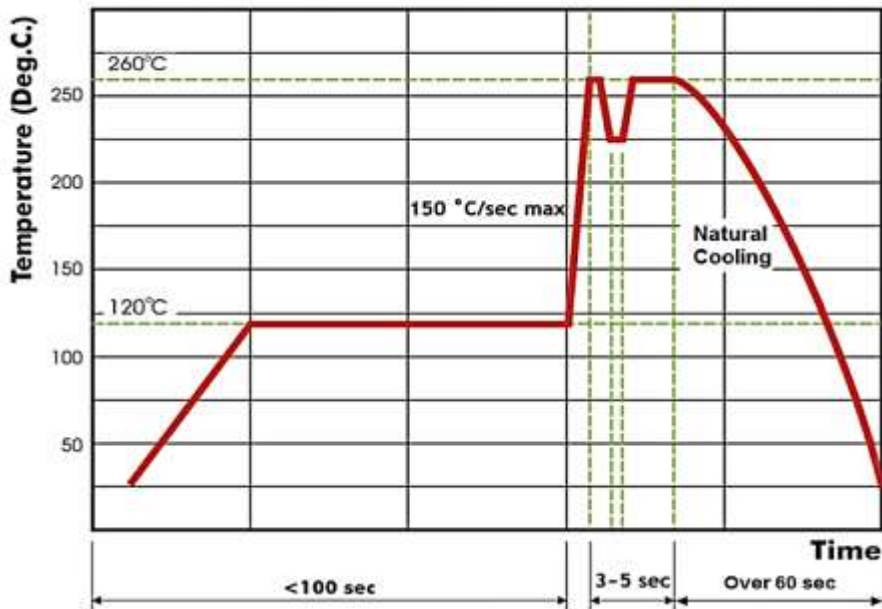

Wave Soldering Profile For SMT Process with SnAgCu series Solder Paste

MULTILAYER CERAMIC CHIP CAPACITORS RF SERIES

REEL DIMENSION (Unit: mm)

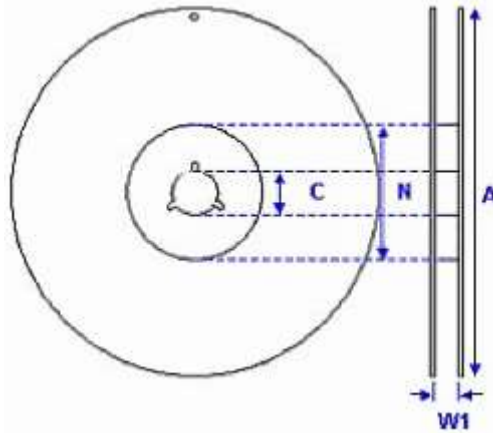

Size Code	01005, 0201, 0402, 0505, 0603, 0805, 1111	
Reel Size	7"	13"
C	13.0+0.5/-0.2	13.0+0.5/-0.2
W 1	8.4+1.5/0	8.4+1.5/-0
A	178.0±0.10	330.0±1.0
N	60.0+1.0/-0	100±1.0

TAPE DIMENSION (Unit: mm)

Paper Tape

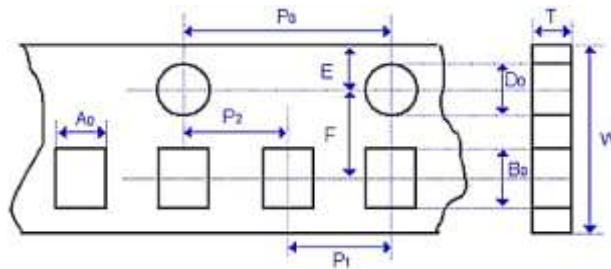

Plastic Tape

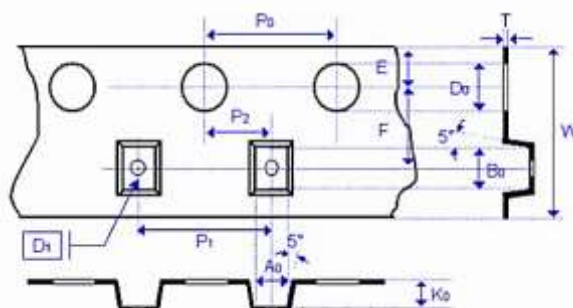

MULTILAYER CERAMIC CHIP CAPACITORS RF SERIES
TAPE DIMENSION (Unit: mm)

Size	01005	0201	0402	0505	0603	0805	1111
Thickness	V	L	N	J	S	T	G
A0	0.25 +/-0.05	0.40 +/-0.07	0.70 +/-0.2	<1.90	1.05 +/-0.30	1.50 +/-0.20	< 3.05
B0	0.45 +/-0.05	0.70 +/-0.07	1.20 +/-0.2	<1.90	1.80 +/-0.30	2.30 +/-0.20	< 3.80
T	≤0.50	≤0.55	≤0.80	0.23 ± 0.10	≤1.20	≤1.20	0.23 +/-0.1
K0	-	-	-	<1.50	-	-	< 2.50
W	8.00 +/-0.10	8.00 +/-0.10	8.00 +/-0.10	8.00 +/-0.20	8.00 +/-0.10	8.00 +/-0.10	8.00 +/-0.20
P0	4.00 +/-0.10	4.00 +/-0.10	4.00 +/-0.10	4.00 +/-0.10	4.00 +/-0.10	4.00 +/-0.10	4.00 +/-0.10
10xP0	40.00 +/-0.10	40.00 +/-0.10	40.00 +/-0.10	40.00 +/-0.20	40.00 +/-0.20	40.00 +/-0.20	40.00 +/-0.20
P1	2.00 +/-0.05	2.00 +/-0.05	2.00 +/-0.05	4.00 +/-0.10	4.00 +/-0.10	4.00 +/-0.10	4.00 +/-0.10
P2	2.00 +/-0.05	2.00 +/-0.05	2.00 +/-0.05	2.00 +/-0.05	2.00 +/-0.05	2.00 +/-0.05	2.00 +/-0.05
D0	1.55 +/-0.05	1.55 +/-0.05	1.55 +/-0.05	1.55 +/-0.05	1.55 +/-0.05	1.55 +/-0.05	1.55 +1/-0
D1	-	-	-	1.00 ± 0.10	-	-	1.00 ± 0.10
E	1.75 +/-0.05	1.75 +/-0.05	1.75 +/-0.05	1.75 +/-0.05	1.75 +/-0.05	1.75 +/-0.05	1.75 +/-0.10
F	3.50 +/-0.05	3.50 +/-0.05	3.50 +/-0.05	3.50 +/-0.05	3.50 +/-0.05	3.50 +/-0.05	3.50 +/-0.05

MULTILAYER CERAMIC CHIP CAPACITORS RF SERIES

STORAGE AND HANDLING CONDITIONS

1. To store products at 5 to 40°C ambient temperature and 20 to 70% related humidity conditions.
2. The product is recommended to be used within one year after shipment. Check solder ability in case of shelf life extension is needed.

CAUTIONS

1. The corrosive gas reacts on the terminal electrodes of capacitors, and results in the poor solder ability. Do not store the capacitors in the ambience of corrosive gas (e.g., hydrogen sulfide, sulfur dioxide, chlorine, ammonia gas etc.)
2. In corrosive atmosphere, solder ability might be degraded, and silver migration might occur to cause low reliability.
3. Due to the dewing by rapid humidity change, or the photochemical change of the terminal electrode by direct sun light, the solder ability and electrical performance may deteriorate. Do not store capacitors under direct sunlight or dewing condition. To store products on the shelf and avoid exposure to moisture.

MULTILAYER CERAMIC CHIP CAPACITORS RF SERIES

IMPORTANT NOTES AND DISCLAIMER

1. **ROHS COMPLIANCE:** The levels of RoHS restricted materials in this product are below the maximum concentration values (also referred to as the threshold limits) permitted for such substances, or are used in an exempted application, in accordance with EU RoHS Directive (EU) 2015/863 EC (RoHS3). RoHS Test Report for this product can be obtained at Download Center.
2. **REACH COMPLIANCE:** REACH substances of high concern (SVHCs) information is available for this product. Since the European Chemical Agency (ECHA) has published notice of their intent to frequently revise the SVHC listing for the foreseeable future, REACH Test Report for this product can be obtained at Download Center.
3. All Product parametric performance is indicated in the Electrical Characteristics for the listed herein test conditions, unless otherwise noted. Product performance may not be indicated by the Electrical Characteristics if operated under different conditions.
4. NextGen Component, Inc (*NextGen*) reserves the right to make changes to this document and its products and specifications at any time without notice. Customers should obtain and confirm the latest product information and specifications before final design, purchase or use.
5. *NextGen* makes no warranty, representation or guarantee regarding the suitability of its products for any particular purpose, not does *NextGen* assume any liability for application assistance or customer product design.
6. *NextGen* does not warrant or accept any liability with products which are purchased or used for any unintended or unauthorized application. No license is granted by implication or otherwise under any intellectual property rights of NextGen.
7. *NextGen* products are not authorized for use as critical components in life support devices or systems without express written approval by *NextGen*.
8. *NextGen* requires that customers first obtain an RMA (Returned Merchandise Authorization) number prior to returning any products. Returns must be made within 30 days of the date of invoice, be in the original packaging, unused and like-new condition. At the time of quoting or purchasing, a product may say that it is Non-Cancelable/ Non-Returnable (NCNR). These products are not returnable and not refundable.