

**SPECIFICATION SHEET**

<b>SPECIFICATION SHEET NO.</b>	R0730- TT8KFTTF000S8K	
<b>DATE</b>	July 30, 2024	
<b>REVISION</b>	A2	Updated With Most Recent Data
<b>DESCRIPTION AND MAIN PARAMETRICS</b>	<p>SMD Glass Passivated Bridge Rectifier, TT Series, Case TTF Type, Reverse Voltage 800V Max. Forward Current 8.0 A Max..</p> <p>Operating Temp. Range -55° C ~+150° C</p> <p>Package in Tape/Reel, 3000pcs/Reel</p> <p>RoHS III/REACH Compliant and Halogen Free (HF)</p>	
<b>CUSTOMER</b>		
<b>CUSTOMER PART NO.</b>		
<b>CROSS REF. PART NO.</b>		
<b>ORIGINAL MFG/PART NO.</b>	MDD Diodes/TT8KF	
<b>PART CODE</b>	TT8KFTTF000S8K	

**VENDOR APPROVE**

Issued/Checked/Approved



DATE: July. 30, 2024

**CUSTOMER APPROVE**

DATE:

**SMD GLASS PASSIVATED BRIDGE RECTIFIER TT SERIES CASE TTF**

**MAIN FEATURE**

- Glass Passivated Chip Junction
- Reverse Voltage - 800 to 1000V
- Forward Current- 8.0 A
- High Surge Current Capability
- REACH/RoHS III Complaint and Halogen Free



- **APPLICATION**

- Designed for Surface Mount Application

- **ELECTRICAL CHARACTERISTICS**

- See Page 4~ Page 5

**HOW TO ORDER**

- Please Follow Up Part Code Guide And Indicate Pat Code When You Order Or RFQ For Custom Specification

**PART CODE GUIDE**

**RFQ**  
Request For Quotation

CODE	NAME	KEY SPECIFICATION OPTION
TT	Product Series Code	SMD Glass Passivated Bridge Rectifiers, TT Series
8KF	Specification Code	8KF: Voltage Range - 800 V, Current - 8.0 A 8MF: Voltage Range - 1000 V, Current - 8.0 A
TTF	Case Code	Case TTF
000S	Internal Control Code	Custom letter A~Z, a-z or Digits (0-9)
8K	Marking Code	8K: Marking "TT8KF" ; 8M: Marking "TT8MF"

**SMD GLASS PASSIVATED BRIDGE RECTIFIER TT SERIES CASE TTF**

**DIMENSION** (Unit: Inch/mm)

Image for reference



**Marking:**

See Page 4 for different  
Part Code

Case TTF

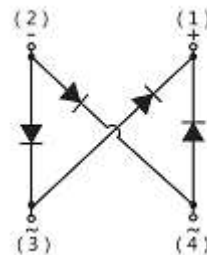
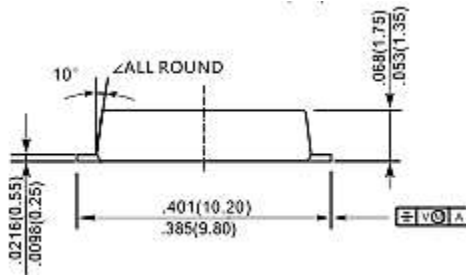
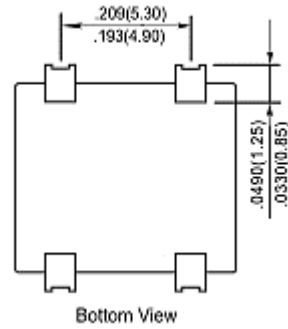
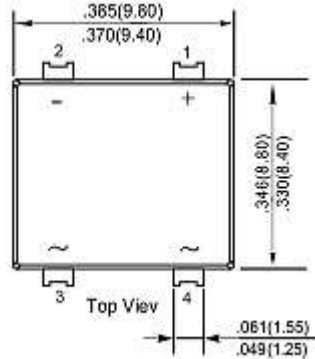

**Recommend Pad Layout**

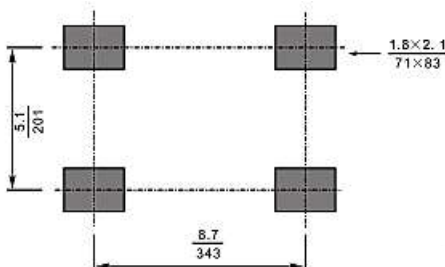

**SMD GLASS PASSIVATED BRIDGE RECTIFIER TT SERIES CASE TTF**
**MECHANICAL DATA**

Case	Terminals	Polarity	Mounting Position	Weight per piece
JEDEC Case TTF Molded plastic body	Solderable per MIL-STD-750, Method 2026	Polarity symbol Marking on body	Any	0.0163 ounce, 0.461 grams

**MAXIMUM RATINGS AND ELECTRICAL CHARACTERISTICS - @ 25 °C**

Part Code	Maximum Repetitive Peak Reverse Voltage	Maximum RMS Voltage	Maximum DC Blocking Voltage	Marking
	V <sub>RRM</sub>	V <sub>RMS</sub>	V <sub>DC</sub>	
	V	V	V	
<a href="#">TT8KFTTF000S8K</a>	800	560	800	TT8KF
TT8MFTTF000S8M	1000	700	1000	TT8MF

**SMD GLASS PASSIVATED BRIDGE RECTIFIER TT SERIES CASE TTF**
**MAXIMUM RATINGS AND ELECTRICAL CHARACTERISTICS- @ 25 °C**

PARAMETER	SYMBOLS	VALUE	UNITS
Maximum Average Forward Rectified Current	I <sub>O</sub>	8.0	A
Peak Forward Surge Current, 8.3ms Single Half Sine-wave Superimposed on Rated Load (JEDEC method)	I <sub>FSM</sub>	220	A
Peak Forward Surge Current 1.0ms Single Half Sine-wave Superimposed on Rated Load	I <sub>FSM</sub>	350	A
Rating for Fusing 1ms ≤ t < 8.3ms	I <sup>2</sup> t	200	A <sup>2</sup> S
Maximum Forward Voltage at 1.0 A	V <sub>F</sub>	0.83 Typ.	V
Maximum Forward Voltage at 4.0 A		1.0	
Maximum DC Reverse Current at Rated DC Blocking Voltage	I <sub>R</sub>	@Ta=25 °C	μA
		@Ta=125 °C	
Typical Junction Capacitance (Note 2)	C <sub>j</sub>	100	pF
Typical Thermal Resistance (Note 3)	R <sub>θJA</sub>	60	°C/W
	R <sub>θJC</sub>	10	
	R <sub>θJL</sub>	12	
Operating and Storage Temperature Range	T <sub>j</sub> , T <sub>stg</sub>	-55 ~ +150	°C

**Note:**

1. Single Phase Half-wave 60hz, resistive Or Inductive Load, For Capacitive Load Current Derate By 20% .
2. Measured At 1mhz And Applied Reverse Voltage Of 4 V D.C.
3. P.C.B. Mounted With 4 × 1.5" × 1.5" ( 3.81 × 3.81 Cm ) copper Pad Areas.

**SMD GLASS PASSIVATED BRIDGE RECTIFIER TT SERIES CASE TTF**

**TYPICAL CHARACTERISTIC CURVES** - For Reference Only

**Fig.1 Average Rectified Output Current Derating Curve**

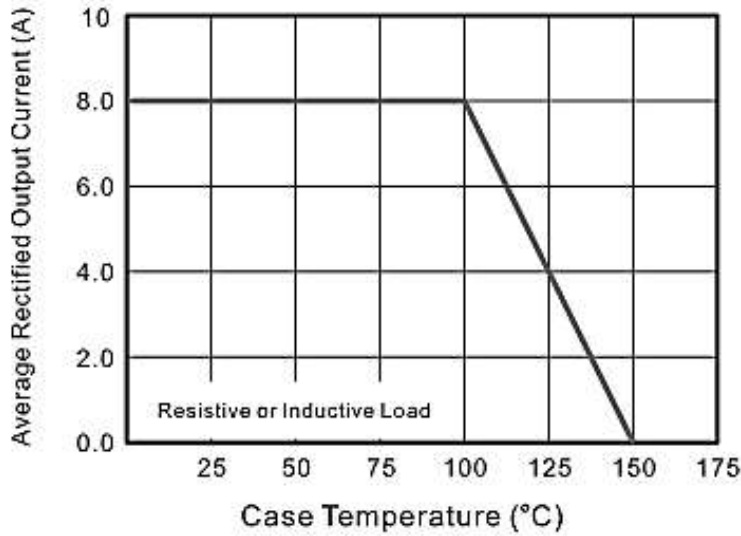

**Fig.2 Typical Reverse Characteristics**

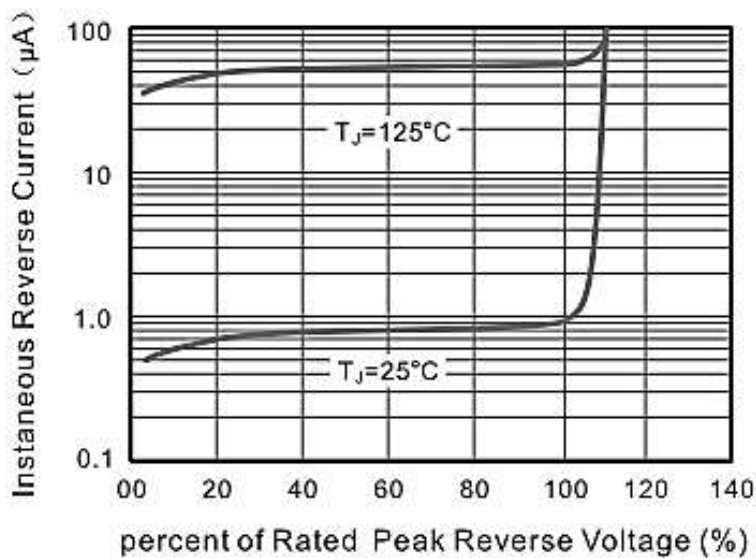

**SMD GLASS PASSIVATED BRIDGE RECTIFIER TT SERIES CASE TTF**

TYPICAL CHARACTERISTIC CURVES - For Reference Only

**Fig.3 Typical Instaneous Forward Characteristics**

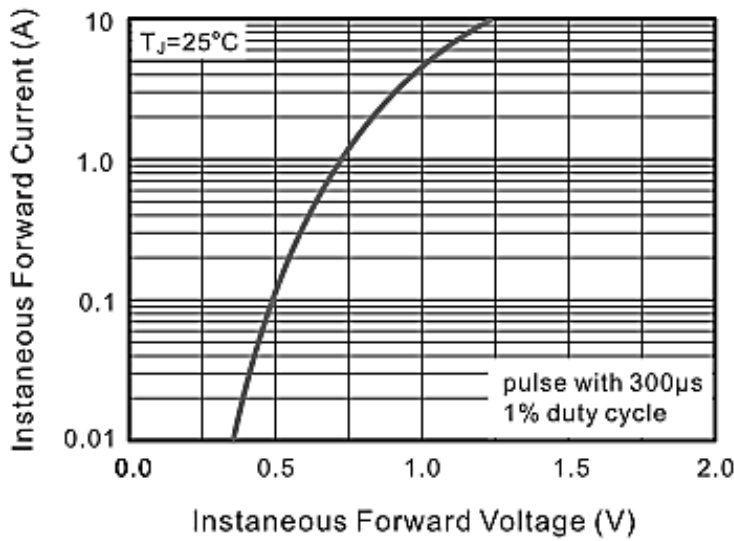

**Fig.4 Typical Junction Capacitance**

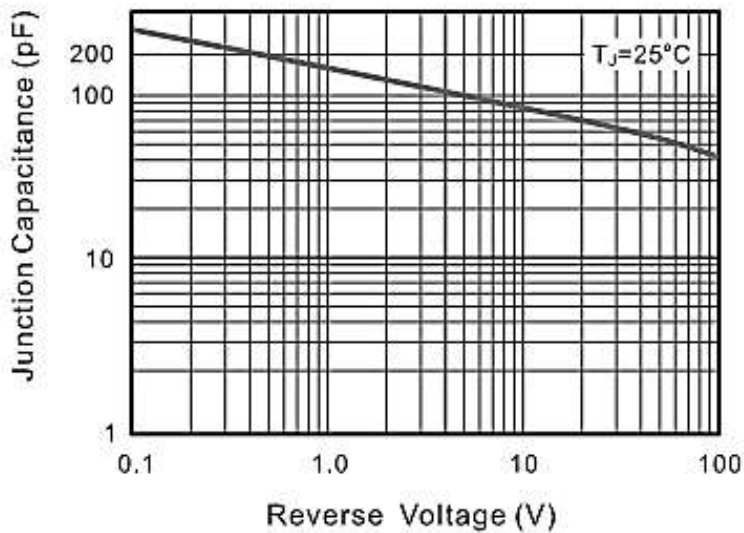

**SMD GLASS PASSIVATED BRIDGE RECTIFIER TT SERIES CASE TTF**

TYPICAL CHARACTERISTIC CURVES - For Reference Only

**Fig.5 Maximum Non-Repetitive Peak Forward Surge Current**

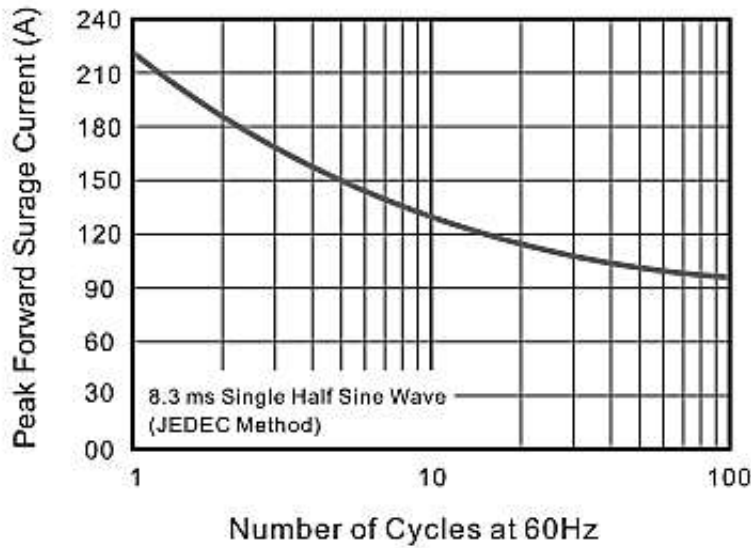

**Fig.6- Typical Transient Thermal Impedance**

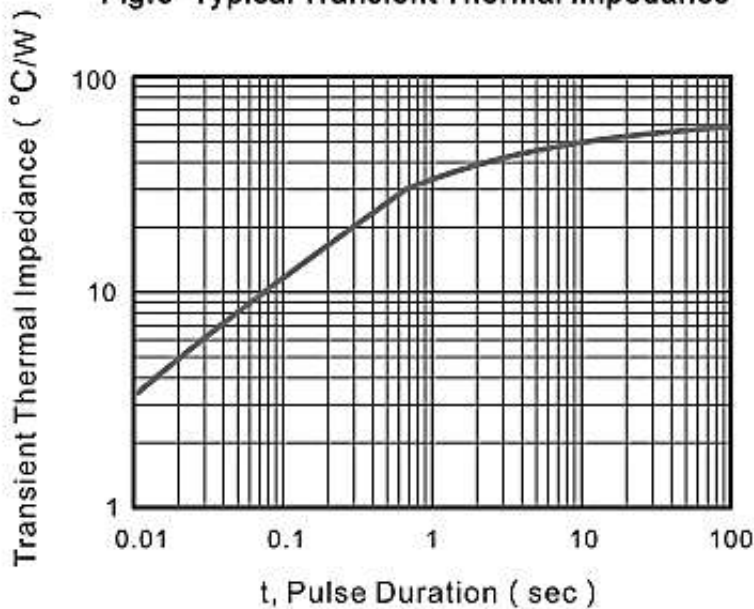



**SMD GLASS PASSIVATED BRIDGE RECTIFIER TT SERIES CASE TTF**
**RELIABILITY**

NUMBER	EXPERIMENT ITEMS	EXPERIMENT METHOD AND CONDITIONS	REFERENCE DOCUMENTS
1	Solder Resistance Test	Test 260°C± 5°C for 10 ± 2 sec. Immerse body into solder 1/16" ± 1/32"	MIL-STD-750D METHOD-2031.2
2	Solderability Test	230°C ±5°C for 5 sec.	MIL-STD-750D METHOD-2026.1 0
3	Pull Test	1 kg in axial lead direction for 10 sec.	MIL-STD-750D METHOD-2036.4
4	Bend Test	0.5Kg Weight Applied To Each Lead, Bending Arcs 90 °C ± 5 °C For 3 Times	MIL-STD-750D METHOD-2036.4
5	High Temperature Reverse Bias Test	TA=100°C for 1000 Hours at VR=80% Rated VR	MIL-STD-750D METHOD-1038.4
6	Forward Operation Life Test	TA=25°C Rated Average Rectified Current	MIL-STD-750D METHOD-1027.3
7	Intermittent Operation Life Test	On state: 5 min with rated IRMS Power Off state: 5 min with Cool Forced Air. On and off for 1000 cycles.	MIL-STD-750D METHOD-1036.3
8	Pressure Cooker Test	15 PSIG, TA=121°C, 4 hours	MIL-S-19500 APPENOIXC
9	Temperature Cycling Test	-55°C~+125°C; 30 Minutes For Dwelled Time 5 minutes for transferred time. Total: 10 cycles.	MIL-STD-750D METHOD-1051.7
10	Thermal Shock Test	0°C for 5 minutes., 100°C for 5minutes, Total: 10 cycles	MIL-STD-750D METHOD-1056.7
11	Forward Surge Test	8.3ms Single Sale Sine-wave One Surge.	MIL-STD-750D METHOD-4066.4
12	Humidity Test	TA=65°C, RH=98% for 1000 hours.	MIL-STD-750D METHOD-1021.3
13	High Temperature Storage life Test	150°C for 1000 Hours	MIL-STD-750D METHOD-1031.5

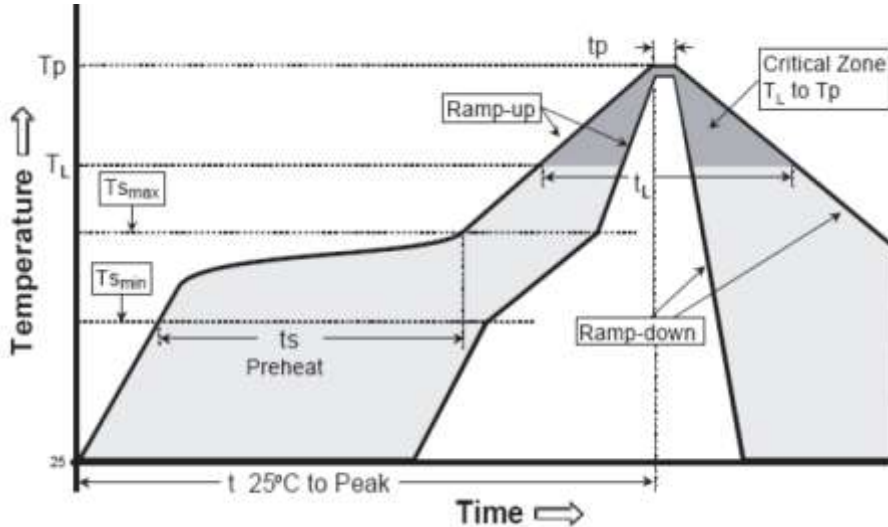
**SMD GLASS PASSIVATED BRIDGE RECTIFIER TT SERIES CASE TTF**
**SUGGESTED REFLOW PROFILE - For Reference Only**

PROFILE FEATURE		PB-FREE ASSEMBLY
Average Ramp-up Rate (Ts Max to Tp)		3°C/second Max
Preheat	Temperature Min (Ts Min.)	150°C
	Temperature Max (Ts Max.)	200°C
	Time (ts Min. to ts Max.)	60~120 seconds
Time maintained above	Temperature (Tl)	217°C
	Time (tl)	60~150 seconds
Peak/Classification Temperature (Tp)		260 +/-5°C
Time within 5°C of actual Peak Temperature (tp)		20~40 seconds
Ramp-down rate		6 °C /Second Max.
Time 25 °C to Peak Temperature		8 minutes Max.
Suggest reflow times		3 Times Max.

**SMD GLASS PASSIVATED BRIDGE RECTIFIER TT SERIES CASE TTF**

**TAPE/REEL** (Unit: mm) All Devices are packed in accordance with EIA standard RS-481-A and specifications.

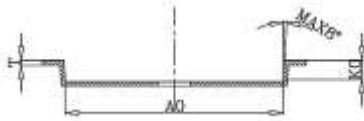
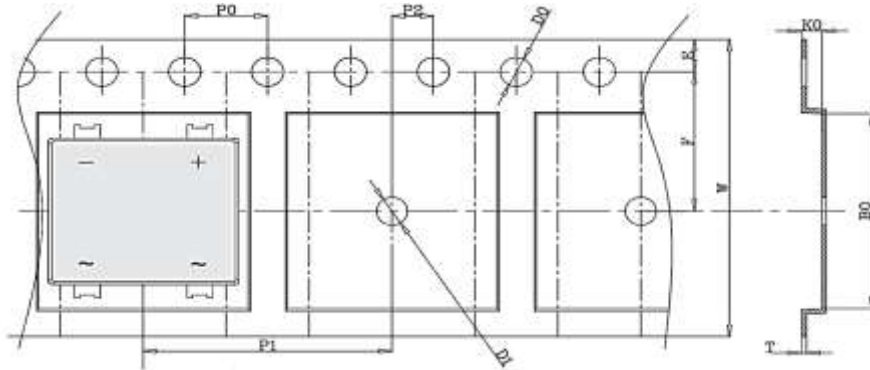

ITEM	SYMBOL	TOL.	CASE TTF
Carrier Width	A0	0.10	10.1
Carrier Length	B0	0.10	10.5
Carrier Depth	K0	0.10	1.85
Sprocket Hole Pitch	P0	0.10	4.00
Punch Hole Pitch	P1	0.10	12.00
Embossment Center	P2	0.05	2.00
Overall Tape Thickness	T	0.03	0.30
Sprocket Hole Position	E	0.10	1.75
Punch Hole Position	F	0.05	7.50
Sprocket Hole	D0	0.05	1.55
Punch Hole	D1	0.25	1.50
Tape Width	W	+0.30/ -0.10	16.0
Qty. /Reel	3000pcs		

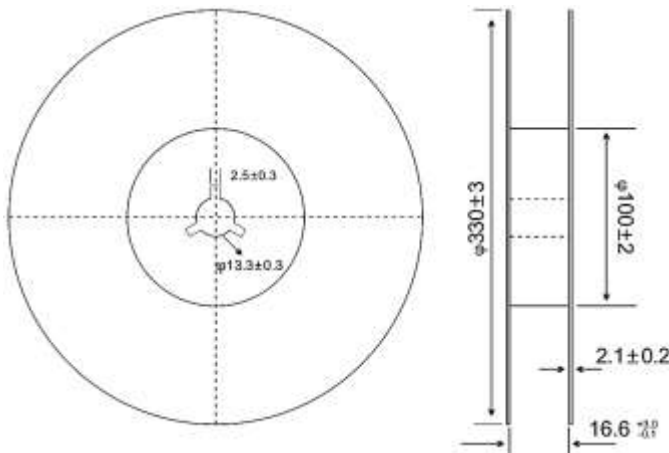

## SMD GLASS PASSIVATED BRIDGE RECTIFIER TT SERIES CASE TTF

### IMPORTANT NOTES AND DISCLAIMER

1. **ROHS COMPLIANCE:** The levels of RoHS restricted materials in this product are below the maximum concentration values (also referred to as the threshold limits) permitted for such substances, or are used in an exempted application, in accordance with EU RoHS Directive (EU) 2015/863 EC (RoHS3). RoHS Test Report for this product can be obtained at Download Center.
2. **REACH COMPLIANCE:** REACH substances of high concern (SVHCs) information is available for this product. Since the European Chemical Agency (ECHA) has published notice of their intent to frequently revise the SVHC listing for the foreseeable future, REACH Test Report for this product can be obtained at Download Center.
3. All Product parametric performance is indicated in the Electrical Characteristics for the listed herein test conditions, unless otherwise noted. Product performance may not be indicated by the Electrical Characteristics if operated under different conditions.
4. NextGen Component, Inc (*NextGen*) reserves the right to make changes to this document and its products and specifications at any time without notice. Customers should obtain and confirm the latest product information and specifications before final design, purchase or use.
5. *NextGen* makes no warranty, representation or guarantee regarding the suitability of its products for any particular purpose, not does *NextGen* assume any liability for application assistance or customer product design.
6. *NextGen* does not warrant or accept any liability with products which are purchased or used for any unintended or unauthorized application. No license is granted by implication or otherwise under any intellectual property rights of NextGen.
7. *NextGen* products are not authorized for use as critical components in life support devices or systems without express written approval by *NextGen*.
8. *NextGen* requires that customers first obtain an RMA (Returned Merchandise Authorization) number prior to returning any products. Returns must be made within 30 days of the date of invoice, be in the original packaging, unused and like-new condition. At the time of quoting or purchasing, a product may say that it is Non-Cancelable/ Non-Returnable (NCNR). These products are not returnable and not refundable.