



SPECIFICATION SHEET

SPECIFICATION SHEET NO.	R0722- 0805B221K501BD	
DATE	July 22, 2024	
REVISION	A3	Updated With Most Recent Data - Official First Release
DESCRIPTION AND MAIN PARAMETRICS	<p>Multilayer Ceramic Chip Capacitors 0805 (2012 Metric) Series, Medium Voltage, L2.00*W1.25*H0.85mm, Thickness: 1.0mm Max. Dielectric X7R, Capacitance 220pF, Tolerance ±10%, Rated Voltage 500V Operating Temp. Range -55°C ~+125°C Package in Tape/Reel, 4,000pcs/Reel RoHS/RoHS III compliant</p>	
CUSTOMER		
CUSTOMER PART NO.		
CROSS REF. PART NO.		
ORIGINAL MFG/PART NO.	Aillen/M0805B221K501BD	
PART CODE	0805B221K501BD	

VENDOR APPROVE			
Issued/Checked/Approved			
DATE: July 22, 2024			

CUSTOMER APPROVE	
DATE:	

MULTILAYER CERAMIC CHIP CAPACITORS 0805 SERIES

DESCRIPTION

MLCC consists of a conducting material and electrodes. To manufacture a chip-type SMT and achieve miniaturization, high density and high efficiency, ceramic condensers are used. MLCC is made by NPO, X7R, and Y5V dielectric material and which provides medium Voltage product with high electrical precision, stability and reliability.

MAIN FEATURE

- RoHS III Compliant
- Wide Operating Temperature Range -55~+125°C
- High Capacitance and High Voltage In Given Case Size
- A Wide Selection Of Sizes Is Available (0603 to 1812)
- Capacitor With Lead-free Termination (Pure Tin)



APPLICATION

- DC to DC converter
- High voltage coupling/DC blocking
- Back-lighting inverters
- Snubbers in high frequency power converters

HOW TO ORDER

- Please indicate part code OR custom parameters code and send us your RFQ by E-mail

MULTILAYER CERAMIC CHIP CAPACITORS 0805 SERIES

PART CODE GUIDE

RFQ
Request For Quotation

CODE	NAME	KEY SPECIFICATION OPTION
0805	Size	0603 (1608): L1.60*W0.80mm; 0805 (2012): L2.00*W1.25mm 1206 (3216): L3.20*W1.60mm; 1210 (3225): L3.20*W2.50mm 1812 (4532): L4.50*W3.20mm
B	Dielectric	N: NPO (COG); B: X7R; Y: Y5V;
221	Capacitance	Two significant digits followed by number of Zero, The 3rd digit signifies the multiplying factor, and letter R is decimal point. 0R5: 0.5pF; 471: 470pF; 102: 1.0nF; 221: 220pF; 333: 33nF
K	Tolerance	B=±0.1pF; C=±0.25pF; D=±0.5pF; F=±1%; G=±2%; J=±5%; K=±10%; M=±20% Z=-20/+80%
501	Rated Voltage	Two significant digits followed by No. of zeros. "R" is in place of decimal point. 201=200 VDC; 251=250 VDC; 501=500 VDC; 631 =630 VDC
B	Thickness	A: 0.60 ± 0.10mm; B: 0.85 ± 0.15mm; C: 0.95 ± 0.10mm; D: 1.25 ± 0.10mm; G: 1.60 ± 0.20mm; I: 1.25 ± 0.20mm; K: 2.00 ± 0.20mm; M: 2.50 ± 0.30mm; N: 0.50+0.05mm; S: 0.80+0.10mm; U: 2.80 ± 0.30mm; X: 0.80 ± 0.20mm
D	Package	K: 0.5 Kpcs/Reel; A: 1Kpcs/Reel; B: 2Kpcs/Reel; C: 3Kpcs/Reel; D: 4Kpcs/Reel; I: 10Kpcs/Reel; F: others
()	Internal Control	Internal Code: Letter + Number; Blank: N/A;

MULTILAYER CERAMIC CHIP CAPACITORS 0805 SERIES

DIMENSION (Unit: mm)

Image for reference

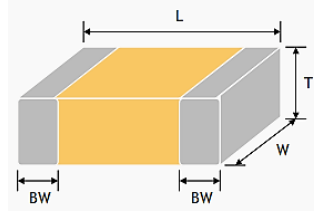

Table 1

Size Code	L	W	T	BW
0603 (1608)	1.60±0.15	0.80±0.15	0.95	0.20
0805 (2012)	2.00±0.20	1.25±0.20	1.45	0.30
1206 (3216)	3.20±0.20	1.60±0.20	1.80	0.30
	3.20+0.3/-0.1	1.60+0.3/-0.1	1.90	
1210 (3225)	3.20±0.40	2.50±0.30	2.80	0.30
1812 (4532)	4.50±0.40	3.20±0.30	2.80	0.26

MULTILAYER CERAMIC CHIP CAPACITORS 0805 SERIES
GENERAL ELECTRONICAL CHARACTERISTICS
Table 2

Dielectric	NPO (COG)	X7R	Y5V
Size	0603, 0805, 1206, 1210, 1812		0805, 1206, 1210, 1812
Capacitance range*	0.5pF to 39.0nF	100pF to 1.0μF	10nF to 1.0μF
Capacitance Tolerance	Cap≤5pF: B (±0.1pF), C (±0.25pF) 5pF<Cap<10pF: C (±0.25pF), D (±0.5pF) Cap≥10pF: F (±1%), G (±2%), J (±5%), K (±10%)	J (±5%), K (±10%), M (±20%)	Z (-20/+80%)
Rated Voltage	200V, 250V, 500V, 630V		200V, 250V
Tan δ*	Cap<30pF: Q≥400+20C Cap≥30pF: Q≥1000	≤2.5% (Apply 1.0±0.2Vrms, 1.0KHz±10%)	≤5%
Insulation resistance at Ur**	≥100GΩ or R•C≥1000 whichever is smaller	≥10GΩ or R•C≥100Ω-F whichever is smaller	
Operating Temperature	-55 ~+125°C		-25 ~+85°C
Capacitance Characteristic	±30ppm/°C	±15%	+30/-80%
Termination	Cu (or Ag)/Ni/Sn (lead-free termination)		

Note:

- 1) * Measured at the condition of 30~70% related humidity.
- 2) NPO: Apply 1.0±0.2Vrms, 1.0MHz±10% for Cap≤1000pF and 1.0±0.2Vrms, 1.0kHz±10% for Cap>1000pF, 25°C at ambient temperature.
- 3) X7R: Apply 1.0±0.2Vrms, 1.0kHz±10%, at 25°C ambient temperature.
- 4) Y5V: Apply 1.0±0.2Vrms, 1.0kHz±10%, at 20°C ambient temperature.
- 5) ** Measured at 500VDC for 60 sec, for UR>500VDC

MULTILAYER CERAMIC CHIP CAPACITORS 0805 SERIES

CAPACITANCE RANGE - NPO DIELECTRIC 0603, 0805, 1206 SIZES

Table 3-A

Size	0603		0805				1206				
	VDC (V)	200	250	200	250	500	630	200	250	500	630
0.5pF (0R5)	S	S	A	A	A	A					
1.0pF (1R0)	S	S	A	A	A	A					
1.2pF (1R2)	S	S	A	A	A	A					
1.5pF (1R5)	S	S	A	A	A	A	B	B	B	B	B
1.8pF (1R8)	S	S	A	A	A	A	B	B	B	B	B
2.2pF (2R2)	S	S	A	A	A	A	B	B	B	B	B
2.7pF (2R7)	S	S	A	A	A	A	B	B	B	B	B
3.3pF (3R3)	S	S	A	A	A	A	B	B	B	B	B
3.9pF (3R9)	S	S	A	A	A	A	B	B	B	B	B
4.7pF (4R7)	S	S	A	A	A	A	B	B	B	B	B
5.6pF (5R6)	S	S	A	A	A	A	B	B	B	B	B
6.8pF (6R8)	S	S	A	A	A	A	B	B	B	B	B
8.2pF (8R2)	S	S	A	A	A	A	B	B	B	B	B
10pF (100)	S	S	A	A	A	A	B	B	B	B	B
12pF (120)	S	S	A	A	A	A	B	B	B	B	B
15pF (150)	S	S	A	A	A	A	B	B	B	B	B
18pF (180)	S	S	A	A	A	A	B	B	B	B	B
20pF (200)	S	S	A	A	A	A	B	B	B	B	B
22pF (220)	S	S	A	A	A	A	B	B	B	B	B
27pF (270)	S	S	A	A	A	A	B	B	B	B	B
30pF (300)	S	S	A	A	A	A	B	B	B	B	B
33pF (330)	S	S	A	A	A	A	B	B	B	B	B
39pF (390)	S	S	A	A	A	A	B	B	B	B	B
47pF (470)	S	S	A	A	A	A	B	B	B	B	B
56pF (560)	S	S	A	A	A	A	B	B	B	B	B
68pF (680)	S	S	A	A	A	A	B	B	B	B	B
82pF (820)	S	S	A	A	A	A	B	B	B	B	B
100pF (101)	S	S	A	A	A	A	B	B	B	B	B
120pF (121)	S	S	A	B	D	D	B	B	B	B	B
150pF (151)	S	S	B	D	D	D	B	B	B	B	B

MULTILAYER CERAMIC CHIP CAPACITORS 0805 SERIES
CAPACITANCE RANGE - NP0 DIELECTRIC 0603, 0805, 1206 SIZES
Table 3-B

Size	0603		0805				1206				
	VDC (V)	200	250	200	250	500	630	200	250	500	630
180pF (181)	S	S	B	D	D	D	D	B	B	B	B
220pF (221)	S	S	D	D	D	D	D	B	B	B	B
270pF (271)	X	X	D	D	D	D	D	B	C	C	C
330pF (331)	X	X	D	D	D	D	D	B	C	C	C
390pF (391)	X	X	D	D	D	D	D	B	C	C	C
470pF (471)	X	X	D	D	I	I	I	C	C	C	C
560pF (561)	X	X	D	D	I	I	I	C	C	C	C
680pF (681)			D	D	I	I	I	C	D	D	D
820pF (821)			D	D	I	I	I	C	D	D	D
1,000pF (102)			D	D	I	I	I	C	G	G	G
1,200pF (122)			D	D				C	G	G	G
1,500pF (152)			D	D				D	G	G	G
1,800pF (182)			D	D				D	G	G	G
2,200pF (222)			D	D				D	G	G	G
2,700pF (272)								D	G		
3,300pF (332)								D	G		
3,900pF (392)								D	G		
4,700pF (472)								D	G		

CAPACITANCE RANGE - NP0 DIELECTRIC 1210, 1812SIZES
Table 3-C

Size	1210				1812				
	VDC (V)	200	250	500	630	200	250	500	630
10pF (100)	C	C	C	C	C	D	D	D	D
12pF (120)	C	C	C	C	C	D	D	D	D
15pF (150)	C	C	C	C	C	D	D	D	D
18pF (180)	C	C	C	C	C	D	D	D	D
20pF (200)	C	C	C	C	C	D	D	D	D
22pF (220)	C	C	C	C	C	D	D	D	D
27pF (270)	C	C	C	C	C	D	D	D	D
33pF (330)	C	C	C	C	C	D	D	D	D

MULTILAYER CERAMIC CHIP CAPACITORS 0805 SERIES

CAPACITANCE RANGE - NPO DIELECTRIC 1210. 1812SIZES

Table 3-D

Size	1210				1812			
	200	250	500	630	200	250	500	630
VDC (V)	200	250	500	630	200	250	500	630
39pF (390)	C	C	C	C	D	D	D	D
47pF (470)	C	C	C	C	D	D	D	D
56pF (560)	C	C	C	C	D	D	D	D
68pF (680)	C	C	C	C	D	D	D	D
82pF (820)	C	C	C	C	D	D	D	D
100pF (101)	C	C	C	C	D	D	D	D
120pF (121)	C	C	C	C	D	D	D	D
150pF (151)	C	C	C	C	D	D	D	D
180pF (181)	C	C	C	C	D	D	D	D
220pF (221)	C	C	C	C	D	D	D	D
270pF (271)	C	C	C	C	D	D	D	D
330pF (331)	C	C	C	C	D	D	D	D
390pF (391)	C	C	C	C	D	D	D	D
470pF (471)	C	C	C	C	D	D	D	D
560pF (561)	C	C	C	C	D	D	D	D
680pF (681)	C	C	C	C	D	D	D	D
820pF (821)	C	C	C	C	D	D	D	D
1,000pF (102)	D	D	D	D	D	D	D	D
1,200pF (122)	D	D	D	D	D	D	D	D
1,500pF (152)	D	D	D	D	D	D	D	D
1,800pF (182)	D	D	D	D	D	D	D	D
2,200pF (222)	D	D	D	D	D	D	D	D
2,700pF (272)	D	D	D	D	D	D	D	D
3,300pF (332)	D	D	D	D	D	D	D	D
3,900pF (392)	D	D	D	D	D	D	D	D
4,700pF (472)	G	G			D	D	D	D
5,600pF (562)	G	G			D	D	D	D
6,800pF (682)	G	G			D	D	D	D
8,200pF (822)	G	G					D	D

MULTILAYER CERAMIC CHIP CAPACITORS 0805 SERIES

CAPACITANCE RANGE - NP0 DIELECTRIC 1210, 1812SIZES

Table 3-E

Size	1210				1812			
VDC (V)	200	250	500	630	200	250	500	630
0.010µF (103)	G	G					D	D
0.022µF (223)	M	M					K	K
0.033µF (333)	M	M					M	M

CAPACITANCE RANGE – X7R DIELECTRIC 0603, 0805 1206 SIZES

Table 4-A

Size	0603		0805				1206			
VDC (V)	200	250	200	250	500	630	200	250	500	630
100pF (101)	X	X	B	B	B	B	D	D	D	D
120pF (121)	X	X	B	B	B	B	D	D	D	D
150pF (151)	X	X	B	B	B	B	D	D	D	D
180pF (181)	X	X	B	B	B	B	D	D	D	D
220pF (221)	X	X	B	B	B	B	D	D	D	D
270pF (271)	X	X	B	B	B	B	D	D	D	D
330pF (331)	X	X	B	B	B	B	D	D	D	D
390pF (391)	X	X	B	B	B	B	D	D	D	D
470pF (471)	X	X	B	B	B	B	D	D	D	D
560pF (561)	X	X	B	B	B	B	D	D	D	D
680pF (681)	X	X	B	B	B	B	D	D	D	D
820pF (821)	X	X	B	B	B	B	D	D	D	D
1,000pF (102)	X	X	B	B	B	B	D	D	D	D
1,200pF (122)	X	X	B	B	B	B	D	D	D	D
1,500pF (152)	X	X	B	B	B	B	D	D	D	D
1,800pF (182)	X	X	B	B	B	B	D	D	D	D
2,200pF (222)	X	X	B	B	B	B	D	D	D	D
2,700pF (272)	X	X	B	B	B	B	D	D	D	D
3,300pF (332)	X	X	B	B	B	B	D	D	D	D
3,900pF (392)	X	X	B	B	B	B	D	D	D	D
4,700pF (472)	X	X	B	B	D	D	D	D	D	D
5,600pF (562)	X	X	D	D	D	D	D	D	D	D

MULTILAYER CERAMIC CHIP CAPACITORS 0805 SERIES
CAPACITANCE RANGE – X7R DIELECTRIC 0603, 0805 1206 SIZES
Table 4-B

Size	0603		0805				1206				
	VDC (V)	200	250	200	250	500	630	200	250	500	630
6,800pF (682)	X	X	D	D	D	D	D	D	D	D	D
8,200pF (822)	X	X	D	D	D	D	D	D	D	D	D
0.010μF (103)	X	X	D	D	D	D	D	D	B/D	D	D
0.012μF (123)			D	D	D	D	D	D	D	D	D
0.015μF (153)			D	D	D	D	D	D	D	D	D
0.018μF (183)			D	D	D	D	D	D	D	D	D
0.022μF (223)			D	D	D	D	D	D	D	G	G
0.027μF (273)			D	D			D	D	D	G	G
0.033μF (333)			D	D			G	G	G	G	G
0.039μF (393)			D	D			G	G	G	G	G
0.047μF (473)			D	D			G	G	G	G	G
0.056μF (563)			D	D			G	G	G	G	G

CAPACITANCE RANGE – X7R DIELECTRIC 0805 1206 SIZES
Table 4-C

Size	0805		1206						
	VDC (V)	200	250	200	250	400	450	500	630
0.068μF (683)	D	D	G	G	G	G			
0.082μF (823)	D		G	G	G	G			
0.10μF (104)	D		G	G	G	G			
0.12μF (124)			G	G					
0.15μF (154)			G	G					
0.18μF (184)			G	G					
0.22μF (224)			G	G					

CAPACITANCE RANGE – X7R DIELECTRIC 1210, 1812 SIZES
Table 4-D

Size	1210				1812				
	VDC (V)	200	250	500	630	200	250	500	630
100pF (101)	D	D	D	D					
120pF (121)	D	D	D	D					
150pF (151)	D	D	D	D					

MULTILAYER CERAMIC CHIP CAPACITORS 0805 SERIES

CAPACITANCE RANGE – X7R DIELECTRIC 1210, 1812 SIZES

Table 4-E

Size	1210				1812			
	200	250	500	630	200	250	500	630
VDC (V)	200	250	500	630	200	250	500	630
180pF (181)	D	D	D	D				
220pF (221)	D	D	D	D				
270pF (271)	D	D	D	D				
330pF (331)	D	D	D	D				
390pF (391)	D	D	D	D				
470pF (471)	D	D	D	D				
560pF (561)	D	D	D	D				
680pF (681)	C	C	D	D				
820pF (821)	C	C	D	D				
1,000pF (102)	C	C	D	D	D	D	D	D
1,200pF (122)	C	C	D	D	D	D	D	D
1,500pF (152)	C	C	D	D	D	D	D	D
1,800pF (182)	C	C	D	D	D	D	D	D
2,200pF (222)	C	C	D	D	D	D	D	D
2,700pF (272)	C	C	D	D	D	D	D	D
3,300pF (332)	C	C	D	D	D	D	D	D
3,900pF (392)	C	C	D	D	D	D	D	D
4,700pF (472)	C	C	D	D	D	D	D	D
5,600pF (562)	C	C	D	D	D	D	D	D
6,800pF (682)	C	C	D	D	D	D	D	D
8,200pF (822)	C	C	D	D	D	D	D	D
0.010μF (103)	C	C	D	D	D	D	D	D
0.012μF (123)	C	C	D	D	D	D	D	D
0.015μF (153)	C	C	D	D	D	D	D	D
0.018μF (183)	C	C	D	D	D	D	D	D
0.022μF (223)	C	C	D	D	D	D	D	D
0.027μF (273)	C	C	G	G	D	D	D	D
0.033μF (333)	C	C	G	G	D	D	D	D
0.039μF (393)	C	C	G	G	D	D	D	D

MULTILAYER CERAMIC CHIP CAPACITORS 0805 SERIES

CAPACITANCE RANGE – X7R DIELECTRIC 1210, 1812 SIZES

Table 4-F

Size	1210						1812			
	VDC (V)	200	250	400	450	500	630	200	250	500
0.047µF (473)	D	D			G	G	D	D	D	D
0.056µF (563)	D	D			G	G	D	D	K	K
0.068µF (683)	D	D			K	K	D	D	K	K
0.082µF (823)	D	D			K	K	D	D	K	K
0.010µF (103)	C	C			D	D	D	D	D	D
0.012µF (123)	C	C			D	D	D	D	D	D
0.015µF (153)	C	C			D	D	D	D	D	D
0.018µF (183)	C	C			D	D	D	D	D	D
0.022µF (223)	C	C			D	D	D	D	D	D
0.027µF (273)	C	C			G	G	D	D	D	D
0.033µF (333)	C	C			G	G	D	D	D	D
0.039µF (393)	C	C			G	G	D	D	D	D
0.047µF (473)	D	D			K	K	D	D	D	D
0.056µF (563)	D	D			G	G	D	D	K	K
0.068µF (683)	G	G			K	K	D	D	K	K
0.082µF (823)	G	G			K	K	D	D	K	K
0.10µF (104)	G	G			K	K	D	D	K	K
0.12µF (124)	G	G	M	M	M	M	D	D	M	M
0.15µF (154)	M	M	M	M	M	M	K	K	M	M
0.18µF (184)	M	M	M	M			K	K	M	M
0.22µF (224)	M	M	M	M			K	K	M	M
0.27µF (274)	M	M	M	M			K	K	M	
0.33µF (334)	M	M	M	M			K	K	M	
0.39µF (394)	M	M					K	K	M	
0.47µF (474)	M	M					K	K	M	
0.56µF (564)	M	M					M	M		
0.68µF (684)	M	M					M	M		
0.84µF (844)							M	M		
1.0µF (105)							M	M		

MULTILAYER CERAMIC CHIP CAPACITORS 0805 SERIES

RELIABILITY TEST CONDITIONS AND REQUIREMENTS

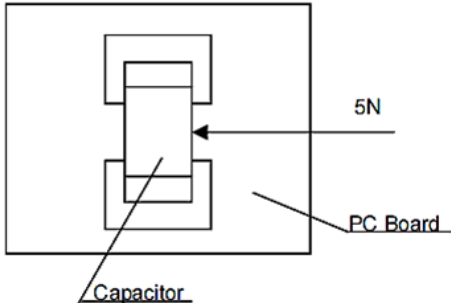
Item	Test Condition	Requirements																
Visual and Mechanical	-	<ul style="list-style-type: none"> * No remarkable defect. * Dimensions to conform to individual spec. sheet. 																
Capacitance	Class I: COG (NP0) $\leq 1000\text{pF}$, $1.0 \pm 0.2\text{Vrms}$, $1\text{MHz} \pm 10\%$	* Shall not exceed the limits given in the detailed spec.																
Q/D.F (Dissipation Factor)	$> 1000\text{pF}$, $1.0 \pm 0.2\text{Vrms}$, $1\text{KHz} \pm 10\%$ Class II: (X7R, Y5V) $1.0 \pm 0.2\text{Vrms}$, $1\text{KHz} \pm 10\%$	NP0: $\text{Cap} \geq 30\text{pF}$, $Q \geq 1000$; $\text{Cap} < 30\text{pF}$, $Q \geq 400 + 20C$ X7R: $\leq 2.5\%$; Y5V: $\leq 5.0\%$																
Dielectric Strength	* To apply voltage: $100\text{V} = 2.5$ times of U_R ; $200\text{V}/250\text{V} = 2$ times of U_R $500\text{V}/630\text{V} = 1.5$ times of U_R ; * Duration: 1 to 5 sec.	* No evidence of damage or flash over during test.																
Insulation Resistance	$U_R = 100\text{V}$: To apply voltage at U_R for max. 120 sec. $U_R > 100\text{V}$: To apply voltage at U_R (500V max.) for 60 sec .	$\geq 10\text{G}\Omega$ or $R_{xC} \geq 100\Omega\text{-F}$ whichever is smaller.																
Temperature Coefficient	With no electrical load @ Operating Temp. Range <table border="1" data-bbox="382 1156 878 1408"> <thead> <tr> <th>T.C</th> <th>Temp. ($^{\circ}\text{C}$)</th> </tr> </thead> <tbody> <tr> <td>NP0(COG)</td> <td>-55~125 at 25</td> </tr> <tr> <td>X7R</td> <td>-55~125 at 25</td> </tr> <tr> <td>Y5V</td> <td>-25~ 85 at 25</td> </tr> </tbody> </table>	T.C	Temp. ($^{\circ}\text{C}$)	NP0(COG)	-55~125 at 25	X7R	-55~125 at 25	Y5V	-25~ 85 at 25	<table border="1" data-bbox="959 1110 1336 1408"> <thead> <tr> <th>T.C</th> <th>Capacitance Change</th> </tr> </thead> <tbody> <tr> <td>NP0 (COG)</td> <td>Within $\pm 30\text{ppm}/^{\circ}\text{C}$</td> </tr> <tr> <td>X7R</td> <td>Within $\pm 15\%$</td> </tr> <tr> <td>Y5V</td> <td>Within $+30\%/-80\%$</td> </tr> </tbody> </table>	T.C	Capacitance Change	NP0 (COG)	Within $\pm 30\text{ppm}/^{\circ}\text{C}$	X7R	Within $\pm 15\%$	Y5V	Within $+30\%/-80\%$
T.C	Temp. ($^{\circ}\text{C}$)																	
NP0(COG)	-55~125 at 25																	
X7R	-55~125 at 25																	
Y5V	-25~ 85 at 25																	
T.C	Capacitance Change																	
NP0 (COG)	Within $\pm 30\text{ppm}/^{\circ}\text{C}$																	
X7R	Within $\pm 15\%$																	
Y5V	Within $+30\%/-80\%$																	
Adhesive Strength of Termination	* Capacitors mounted on a substrate. A force of 5N(≤ 0603) or 10N(> 0603) applied perpendicular to the place of substrate and parallel the line joining the center of terminations for 10 ± 1 second. 	* No remarkable damage or removal of the terminations.																

7/22/2024

MULTILAYER CERAMIC CHIP CAPACITORS 0805 SERIES
RELIABILITY TEST CONDITIONS AND REQUIREMENTS

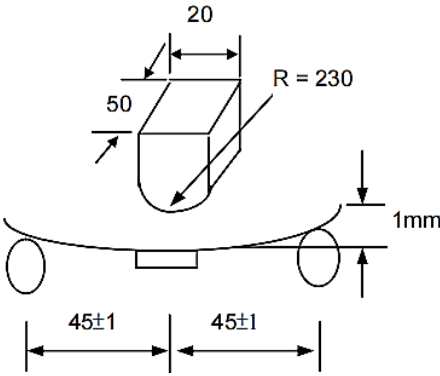
Item	Test Condition	Requirements
Vibration Resistance	Vibration frequency: 10~55 Hz/min. * Total amplitude: 1.5mm * Test time: 6 hrs. (Two hrs each in three mutually perpendicular directions.)	* No remarkable damage. * Cap change and Q/D.F.: To meet initial spec.
Resistance to Flexure of Substrate	* The middle part of substrate shall be pressurized by means of the pressurizing rod at a rate of about 1mm per second until the deflection becomes 1mm. 	* No remarkable damage. * Cap change: COG(NPO): within $\pm 5.0\%$ or $\pm 0.5\text{pF}$ whichever is larger. X7R: within $\pm 12.5\%$ Y5V: within $\pm 30\%$ (This capacitance change means the change of capacitance under specified flexure of substrate from the capacitance measured before the test.)
Resistance to Soldering Heat	* Solder temperature: $260 \pm 5^\circ \text{C}$ * Dipping time: $10 \pm 1 \text{ sec}$ * Preheating: 120 to 150°C for 1 minute before immerse the capacitor in a eutectic solder. * Before initial measurement (Class II only): To apply de-aging at 150°C for 1hr then set for $24 \pm 2 \text{ hrs}$ at room temp. * Measurement to be made after de-aging at 150°C for 1hr then set for $24 \pm 2 \text{ hrs}$ at room	* No remarkable damage. * Cap change: NPO: within $\pm 2.5\%$ or 0.25pF whichever is larger X7R: within $\pm 7.5\%$; Y5V: within $\pm 20\%$ * Q/D.F, COG(NPO) / X7R / Y5V : $\leq 1.0 \times$ initial requirements. * 25% max. leaching on each edge.

MULTILAYER CERAMIC CHIP CAPACITORS 0805 SERIES

RELIABILITY TEST CONDITIONS AND REQUIREMENTS

Item	Test Condition	Requirements															
Resistance to Soldering Heat	<ul style="list-style-type: none"> * Solder temperature: $260 \pm 5^\circ \text{C}$ * Dipping time: $10 \pm 1 \text{ sec}$ * Preheating: $120 \text{ to } 150^\circ \text{C}$ for 1 minute before immerse the capacitor in a eutectic solder. * Before initial measurement (Class II only): To apply de-aging at 150°C for 1hr then set for $24 \pm 2 \text{ hrs}$ at room temp. * Measurement to be made after de-aging at 150°C for 1hr then set for $24 \pm 2 \text{ hrs}$ at room 	<ul style="list-style-type: none"> * No remarkable damage. * Cap change: NPO: within $\pm 2.5\%$ or 0.25pF whichever is larger X7R: within $\pm 7.5\%$; Y5V: within $\pm 20\%$ * Q/D.F., $\text{COG(NPO) / X7R / Y5V} : \leq 1.0 \times$ initial requirements. * 25% max. leaching on each edge. 															
Temperature Cycle	<p>*Conduct the five cycles according to the temperatures and time.</p> <table border="1" style="width: 100%; border-collapse: collapse;"> <thead> <tr> <th>Step</th> <th>Temp. ($^\circ\text{C}$)</th> <th>Time(min)</th> </tr> </thead> <tbody> <tr> <td>1</td> <td>Min. operating temp.+0/-3</td> <td>30 ± 3</td> </tr> <tr> <td>2</td> <td>Room temp.</td> <td>2~3</td> </tr> <tr> <td>3</td> <td>Max. operating temp.+3/-0</td> <td>30 ± 3</td> </tr> <tr> <td>4</td> <td>Room temp.</td> <td>2~3</td> </tr> </tbody> </table> <ul style="list-style-type: none"> * Before initial measurement (Class II only): Perform $150+0/-10^\circ \text{C}$ for 1 hr and then set for $48 \pm 4 \text{ hrs}$ at room temp. * Measurement to be made after keeping at room temp. for $24 \pm 2 \text{ hrs}$ (Class I) or $48 \pm 4 \text{ hrs}$ (Class II). 	Step	Temp. ($^\circ\text{C}$)	Time(min)	1	Min. operating temp.+0/-3	30 ± 3	2	Room temp.	2~3	3	Max. operating temp.+3/-0	30 ± 3	4	Room temp.	2~3	<ul style="list-style-type: none"> * No remarkable damage. * Cap change: NPO: within $\pm 2.5\%$ or 0.25pF whichever is larger X7R: within $\pm 7.5\%$ Y5V: within $\pm 20\%$ * Q/D.F., $\text{COG(NPO) / X7R / Y5V} : \leq 1.0 \times$ Initial requirement * I.R. $\geq 0.25 \times$ initial requirements.
Step	Temp. ($^\circ\text{C}$)	Time(min)															
1	Min. operating temp.+0/-3	30 ± 3															
2	Room temp.	2~3															
3	Max. operating temp.+3/-0	30 ± 3															
4	Room temp.	2~3															
Solder ability	<ul style="list-style-type: none"> * Solder temperature: $235 \pm 5^\circ \text{C}$ * Dipping time: $2 \pm 0.5 \text{ sec}$. 	95% min. coverage of all metalized area															

MULTILAYER CERAMIC CHIP CAPACITORS 0805 SERIES

RELIABILITY TEST CONDITIONS AND REQUIREMENTS

Item	Test Condition	Requirements																	
High Temperature Load (Endurance)	<p>Test temp.:</p> <p>COG(NPO), X7R: $125 \pm 3^\circ \text{C}$; Y5V: $85 \pm 3^\circ \text{C}$</p> <p>* To apply voltage:</p> <p>(1) $U_R \leq 250\text{V}$: 200% of rated voltage.</p> <p>Exception item</p> <table border="1" style="margin-left: 20px;"> <thead> <tr> <th>UR</th> <th>Size</th> <th>Cap</th> <th>Voltage</th> </tr> </thead> <tbody> <tr> <td rowspan="2">100V</td> <td>0805</td> <td>≥ 124</td> <td rowspan="2">1.5 times of UR</td> </tr> <tr> <td>1206/1210</td> <td>≥ 105</td> </tr> <tr> <td rowspan="2">200V and 250V</td> <td>1210</td> <td>> 224</td> <td></td> </tr> <tr> <td>1812</td> <td>> 474</td> <td></td> </tr> </tbody> </table> <p>(2) $250 < U_R \leq 500\text{V}$: 150% of rated voltage.</p> <p>(3) $U_R > 500\text{V}$: 120% of rated voltage.</p> <p>(4) 1206,NP0 $\geq 1.5\text{pF}$: 100% of rated voltage.</p> <p>* Test temp.: $40 \pm 2^\circ \text{C}$</p> <p>* Humidity: 90~95% RH</p> <p>* Test time: 1000+24/-0 hrs.</p> <p>* Measurement to be made after keeping at room temp. for 24 ± 2 hrs (Class I) or 48 ± 4 hrs (Class II).</p>	UR	Size	Cap	Voltage	100V	0805	≥ 124	1.5 times of UR	1206/1210	≥ 105	200V and 250V	1210	> 224		1812	> 474		<p>* No remarkable damage.</p> <p>* Cap change:</p> <p>COG(NPO) : within $\pm 3\%$ or $\pm 0.3\text{pF}$ whichever is larger</p> <p>X7R : within $\pm 12.5\%$</p> <p>Y5V : within $\pm 30\%$</p> <p>* Q/D.F Value:</p> <p>COG(NPO): $\text{Cap} \geq 30\text{pF} : Q \geq 350$; $10\text{pF} \leq \text{Cap} < 30\text{pF} : Q \geq 275 + 2.5C$; $\text{Cap} < 10\text{pF} : Q \geq 200 + 10C$</p> <p>X7R: $\leq 3.0\%$</p> <p>Y5V: $\leq 7.5\%$</p> <ul style="list-style-type: none"> I.R.: $\geq 1\text{G}\Omega$ or $R_x C \geq 50\Omega \cdot \text{F}$ whichever is smaller.
UR	Size	Cap	Voltage																
100V	0805	≥ 124	1.5 times of UR																
	1206/1210	≥ 105																	
200V and 250V	1210	> 224																	
	1812	> 474																	
Resistance to Soldering Heat	<p>* Solder temperature: $260 \pm 5^\circ \text{C}$</p> <p>* Dipping time: 10 ± 1 sec</p> <p>* Preheating: 120 to 150°C for 1 minute before immerse the capacitor in a eutectic solder.</p> <p>* Before initial measurement (Class II only): To apply de-aging at 150°C for 1hr then set for 24 ± 2 hrs at room temp.</p> <p>* Measurement to be made after de-aging at 150°C for 1hr then set for 24 ± 2 hrs at room</p>	<p>* No remarkable damage.</p> <p>* Cap change:</p> <p>NP0: within $\pm 2.5\%$ or 0.25pF whichever is larger</p> <p>X7R: within $\pm 7.5\%$;</p> <p>Y5V: within $\pm 20\%$</p> <p>* Q/D.F,</p> <p>COG(NPO) / X7R / Y5V : $\leq 1.0 \times$ initial requirements.</p> <p>* 25% max. leaching on each edge.</p>																	

MULTILAYER CERAMIC CHIP CAPACITORS 0805 SERIES

RECOMMENDED PROFILE CONDITIONS

PREHEAT:

In order to minimize the risk of thermal shock during soldering, a carefully controlled preheat is required. The rate of preheat should not exceed 4°C per second and the final preheat temperature should be within 100°C of the soldering temperature for small chips such as 0603, 0805 and 1206, within 50°C of the soldering temperature for bigger chips such as 1210 and 1812 etc.

SOLDERING

1. Use midly activated rosin RA and RMA fluxes do not use activated flux. The amount of solder in each solder joint should be controlled to prevent the damage of chip capacitors caused by the stress between solder, chips, and substrate.
2. Hand soldering with temperature-controlled iron not exceeding 30 watts and diameter of tip less than 1.2mm is recommended, tip of iron should not contact the ceramic body directly, and the temperature of iron should be set to not more than 260°C.
3. For bigger chips such as 1210 and 1812, etc. wave soldering and hand soldering are no recommended.
4. Refer IPC/JEDEC J-STD-020D Method recommended soldering profiles : Reflow not sooner than 15 minutes and not longer than 4 hrs after removal from the temperature/humidity chamber, subject the sample to 3 cycle of the appropriate reflow conditions as defined as blow Table description.
5. Lead-free : Soldering temperature = 235 to 260°C, depending on product.
6. Maximum temperature = Minimum temperature (235°C)+ ΔT + Tolerance for oven process and measurement (5 ~ 7°C)
7. Time at peak temperature = 10sec, Dwell above 217°C = 90sec, Ramping rate = 3°C/sec(heating) and 6 °C/sec (heating).

COOLING

After soldering, cool the chips and the substrate gradually to room temperature. Natural cooling in air is recommended to minimize stress in the solder joint. A cooling rate not exceeding 4°C per second should be used when forced cooling is necessary.

CLEANING

All flux residues must be removed by using suitable electronic-grade vapor-cleaning solvents to eliminate contamination that could cause electrolytic surface corrosion. Good results can be obtained by using ultrasonic cleaning of the solvent. The choice of the proper system is depends upon many factors such as component mix, flux, and solder paste and assembly method. The ability of the cleaning system to remove flux residues and contamination from under the chips is very important.

MULTILAYER CERAMIC CHIP CAPACITORS 0805 SERIES

RECOMMENDED PROFILE CONDITIONS

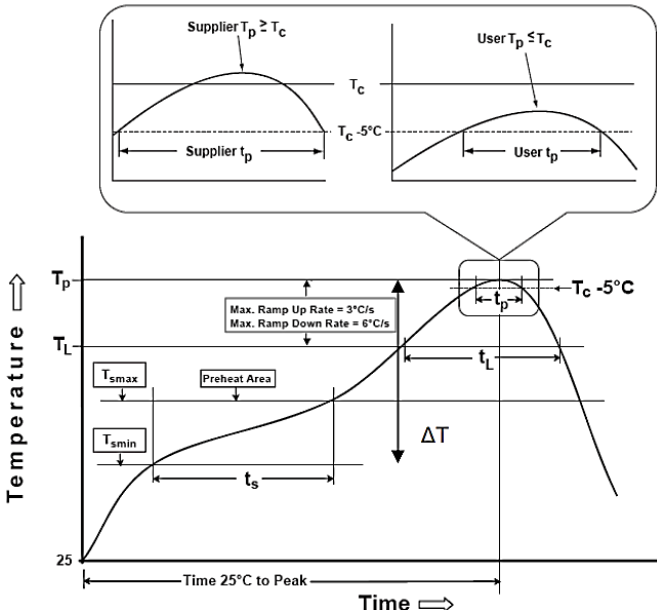

Chip Size	ΔT
0603, 0805, 1206	100 °C
1210, 1812	50 °C

Soldering	Solder Temp.(Tc)	Soldering Time (tp)
Reflow	235 – 260 °C	< 15 sec.
Wave	230 – 260 °C	< 5 sec.

Profile Feature		Pb-Free Assembly
Preheat /Soak	Temperature Min.(Tsmin)	150°C
	Temperature Max.(Tsmax)	200°C
	Time(ts) from (Tsmin~Tsmax)	60 to 120 seconds
Ramp-up rate(TL to Tp)		3 °C/second max.
Liquidous temperature(TL)		217°C
Time(tL) maintained above TL		60 to 150 seconds
Peak package body temperature(Tp)		For user Tp must not exceed the Classification temp 260°C For suppliers Tp must equal or exceed the Classification temp 260°C
Time(Tp)* within 5 of the specified °C classification temperature(Tc)		30* second
Ramp-down rate (Tp to TL)		6 /second max.
Time 25 to peak temperature 260 °C °C		8 minutes max.

Note: For example, Tc is 260°C and time tp is 15sec. for user: The peak temperature must not exceed 260°C. The time above 255°C must not exceed 15 seconds.

MULTILAYER CERAMIC CHIP CAPACITORS 0805 SERIES

PACKAGING STYLE AND QUANTITY

Size	Thickness (Symbol)		Paper Tape		Plastic Tape	
			7" Reel	13" Reel	7" Reel	13" Reel
0603 (1608)	0.50±0.10	N	4,000			
	0.80±0.07	S	4,000	15,000		
	0.80+0.15/-0.10	X	4,000	15,000		
0805 (2012)	0.50±0.10	N	4,000	15,000		
	0.60±0.10	A	4,000	15,000		
	0.85±0.15	B	4,000	15,000		
	0.85±0.10	T	4,000	15,000		
	1.25±0.15	C			3,000	10,000
1206 (3216)	0.85±0.15	B	4,000	15,000		
	0.85±0.10	T	4,000	15,000		
	0.95±0.10	I			3,000	10,000
	1.15±0.15	J			3,000	10,000
	1.25±0.15	C			3,000	10,000
	1.60±0.15	D			2,000	10,000
	1.60+0.30/-0.10	P			2,000	9,000
1210 (3225)	0.85±0.10	T			3,000	10,000
	0.95±0.10	I			3,000	10,000
	1.25±0.15	C			3,000	10,000
	1.60±0.15	D			2,000	
	2.00±0.20	K			1,000	6,000
	2.50±0.30	M			1,000	6,000

MULTILAYER CERAMIC CHIP CAPACITORS 0805 SERIES

PACKAGING STYLE AND QUANTITY

Size	Thickness (Symbol) (mm)		Paper Tape		Plastic Tape	
			Pcs/7" Reel	pcs/13" Reel	Pcs/7" Reel	Pcs/13" Reel
1812 (4532)	1.25±0.15	C			1,000	5,000
	1.60±0.15	D			1,000	
	2.00±0.20	K			1,000	
	2.50±0.30	M			500	3,000
	2.80±0.30	U			500	

REEL DIMENSION (Unit: mm)

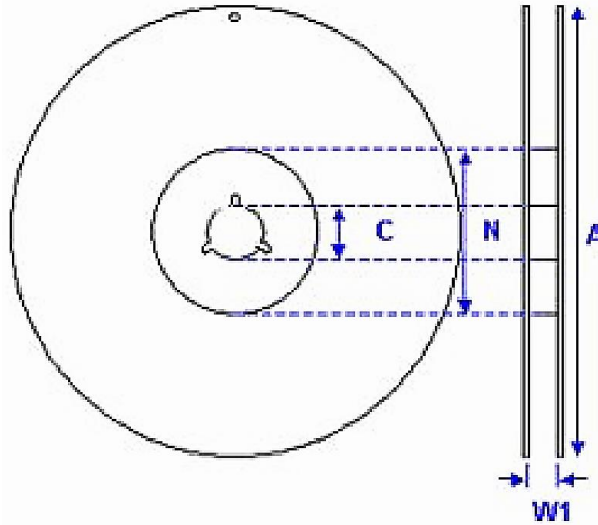

Size Code	0603, 0805, 1206, 1210			1812
Reel Size	7"	10"	13"	7"
C	13.0+0.5/-0.2	13.0+0.5/-0.2	13.0+0.5/-0.2	13.0+0.5/-0.2
W 1	8.4+1.5/0	8.4+1.5/-0	8.4+1.5/-0	12.4+2.0/-0
A	178.0±0.10	250.0±1.0	330.0±1.0	178.0±0.10
N	60.0+1.0/-0	100.0±1.0	100±1.0	60.0+1.0/-0

MULTILAYER CERAMIC CHIP CAPACITORS 0805 SERIES

TAPE DIMENSION (Unit: mm)

Paper Tape

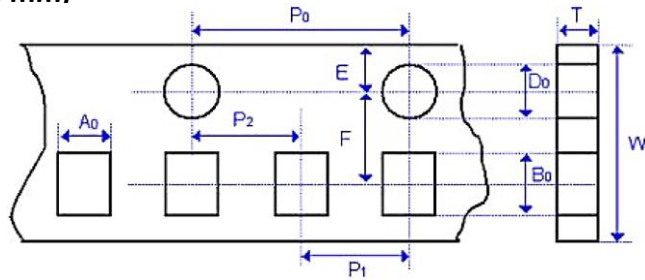

Plastic Tape

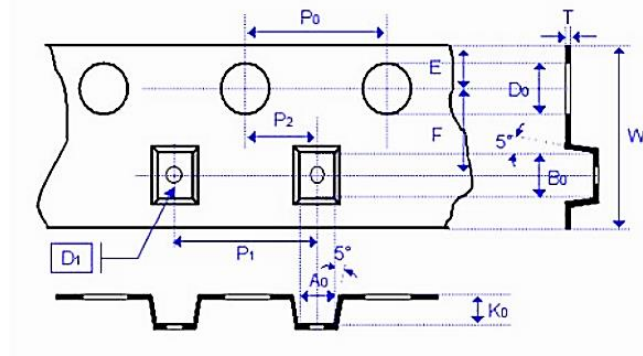

Size	0603	0805		
Thickness	S, B, X	A, H	B, X	C
A0	1.05 +/-0.30	1.5+/-0.20	1.5 +/-0.20	< 1.80
B0	1.80 +/-0.30	2.30 +/-0.20	2.30 +/-0.20	< 2.70
T	≤1.20	≤1.15	≤1.20	0.23 +/-0.1
K0	-	-	-	< 2.50
W	8.00 +/-0.30	8.00 +/-0.30	8.00 +/-0.30	8.00 +/-0.30
P0	4.00 +/-0.10	4.00 +/-0.10	4.00 +/-0.10	4.00 +/-0.10
10xP0	40.0 +/-0.20	40.0 +/-0.20	40.0 +/-0.20	40.0 +/-0.20
P1	4.00 +/-0.10	4.00 +/-0.10	4.00 +/-0.10	4.00 +/-0.10
P2	2.00 +/-0.05	2.00 +/-0.05	2.00 +/-0.05	2.00 +/-0.05
D0	1.50 +0.1/-0	1.50 +0.1/-0	1.50 +0.1/-0	1.50 +0.1/-0
D1	-	-	-	1.00 +/-0.10
E	1.75 +/-0.10	1.75 +/-0.10	1.75 +/-0.10	1.75 +/-0.10
F	3.50 +/-0.05	3.50 +/-0.05	3.50 +/-0.05	3.50 +/-0.05

MULTILAYER CERAMIC CHIP CAPACITORS 0805 SERIES
TAPE DIMENSION (Unit: mm)

Size	1206			1210		
	B	I, C,	D,	B	I, C, D, K	M
Thickness						
A0	1.90 +/-0.50	< 2.00	< 2.30	< 3.05	< 3.05	< 3.20
B0	3.50 +/-0.50	< 3.70	< 4.00	< 3.80	< 3.80	< 4.00
T	≤1.20	0.23 +/-0.1	0.23 +/-0.1	0.23 +/-0.1	0.23 +/-0.1	0.23 +/-0.1
K0	-	< 2.50	< 2.50	< 1.50	< 2.50	< 3.20
W	8.00 +/-0.30	8.00 +/-0.30	8.00 +/-0.30	8.00 +/-0.30	8.00 +/-0.30	8.00 +/-0.30
P0	4.00 +/-0.10	4.00 +/-0.10	4.00 +/-0.10	4.00 +/-0.10	4.00 +/-0.10	4.00 +/-0.10
10xP0	40.0 +/-0.20	40.0 +/-0.20	40.0 +/-0.20	40.0 +/-0.20	40.0 +/-0.20	40.0 +/-0.20
P1	4.00 +/-0.10	4.00 +/-0.10	4.00 +/-0.10	4.00 +/-0.10	4.00 +/-0.10	4.00 +/-0.10
P2	2.00 +/-0.05	2.00 +/-0.05	2.00 +/-0.05	2.00 +/-0.05	2.00 +/-0.05	2.00 +/-0.05
D0	1.50 +0.1/-0	1.50 +0.1/-0	1.50 +0.1/-0	1.50 +0.1/-0	1.50 +0.1/-0	1.50 +0.1/-0
D1	-	1.00 +/-0.10	1.00 +/-0.10	1.00 +/-0.10	1.00 +/-0.10	1.00 +/-0.10
E	1.75 +/-0.10	1.75 +/-0.10	1.75 +/-0.10	1.75 +/-0.10	1.75 +/-0.10	1.75 +/-0.10
F	3.50 +/-0.05	3.50 +/-0.05	3.50 +/-0.05	3.50 +/-0.05	3.50 +/-0.05	3.50 +/-0.05

Size	1812	
	C, D, K	M
Thickness		
A0	< 3.90	< 3.90
B0	< 5.30	< 5.30
T	0.25 +/-0.1	0.25 +/-0.1
K0	< 2.50	< 3.50
W	12.00 +/-0.30	12.00 +/-0.30
P0	4.00 +/-0.10	4.00 +/-0.10
10xP0	40.0 +/-0.20	40.0 +/-0.20
P1	8.00 +/-0.10	8.00 +/-0.10
P2	2.00 +/-0.10	2.00 +/-0.10
D0	1.50 +0.1/-0	1.50 +0.1/-0
D1	1.50 +/-0.10	1.50 +/-0.10
E	1.75 +/-0.10	1.75 +/-0.10
F	5.50 +/-0.10	5.50 +/-0.10

MULTILAYER CERAMIC CHIP CAPACITORS 0805 SERIES

STORAGE AND HANDLING CONDITIONS

- To store products at 5 to 40°C ambient temperature and 20 to 70% related humidity conditions.
- The product is recommended to be used within one year after shipment. Check solder ability in case of shelf life extension is needed.
- Don't open the tape until the parts are to be used, use the chips within 3 months after the tape is opened.
- For product of high dielectric constant (Class2&3, characteristics B/W & Y), the Electro static capacity changes with the passage of time due to the inherent characteristics of ceramic dielectric materials. The changed capacity reverts to nominal at the temperature it reaches during the soldering process.

CAUTIONS

- The corrosive gas reacts on the terminal electrodes of capacitors, and results in the poor solder ability. Do not store the capacitors in the ambience of corrosive gas (e.g., hydrogen sulfide, sulfur dioxide, chlorine, ammonia gas etc.)
- In corrosive atmosphere, solder ability might be degraded, and silver migration might occur to cause low reliability.
- Due to the dewing by rapid humidity change, or the photochemical change of the terminal electrode by direct sun light, the solder ability and electrical performance may deteriorate. Do not store capacitors under direct sunlight or dewing condition. To store products on the shelf and avoid exposure to moisture.

ROHS COMPLIANCE

- The levels of RoHS restricted materials in this product are below the maximum concentration values (also referred to as the threshold limits) permitted for such substances, or are used in an exempted application, in accordance with EU RoHS Directive (EU) 2015/863 EC (RoHS3). RoHS Test Report for this product can be obtained can be obtained at Download Center.

MULTILAYER CERAMIC CHIP CAPACITORS 0805 SERIES

REACH COMPLIANCE

- REACH substances of high concern (SVHCs) information is available for this product. Since the European Chemical Agency (ECHA) has published notice of their intent to frequently revise the SVHC listing for the foreseeable future, REACH Test Report for this product can be obtained can be obtained at Download Center.

IMPORTANT NOTES AND DISCLAIMER

1. All Product parametric performance is indicated in the Electrical Characteristics for the listed herein test conditions, unless otherwise noted. Product performance may not be indicated by the Electrical Characteristics if operated under different conditions.
2. NextGen Component, Inc (*NextGen*) reserves the right to make changes to this document and its products and specifications at any time without notice. Customers should obtain and confirm the latest product information and specifications before final design, purchase or use.
3. *NextGen* makes no warranty, representation or guarantee regarding the suitability of its products for any particular purpose, not does NextGen assume any liability for application assistance or customer product design.
4. *NextGen* does not warrant or accept any liability with products which are purchased or used for any unintended or unauthorized application. No license is granted by implication or otherwise under any intellectual property rights of NextGen.
5. *NextGen* products are not authorized for use as critical components in life support devices or systems without express written approval by *NextGen*.
6. *NextGen* requires that customers first obtain an RMA (Returned Merchandise Authorization) number prior to returning any products. Returns must be made within 30 days of the date of invoice, be in the original packaging, unused and like-new condition. At the time of quoting or purchasing, a product may say that it is Non-Cancelable/ Non-Returnable (NCNR). These products are not returnable and not refundable.