



SPECIFICATION SHEET

SPECIFICATION SHEET NO.	N0729-SOD1234148WST4
DATE	July 29, 2021
REVISION	A0
DESCRIPTION	<p>SMD Fast Switching diodes, SOD-123 series, 2 pads, Type 1N4148W T4 Reverse Voltage 100V Max. Forward Current 0.30A Max. Operating Temp. Range -65°C ~+150°C, Package in Tape/Reel, 3000pcs/Reel RoHS/RoHS III compliant</p>
CUSTOMER	
CUSTOMER PART NUMBER	
CROSS REF. PART NUMBER	
ORIGINAL PART NUMBER	MDD 1N4148W T4
PART CODE	SOD1234148WST4

VENDOR APPROVE			
Issued/Checked/Approved			
DATE: July 29, 2021			

CUSTOMER APPROVE	
DATE:	

SMD FAST SWITCHING DIODES SOD123 SERIES

MAIN FEATURE

- Fast switching speed
- Surface mount package ideally suited for automatic insertion
- High conductance



APPLICATION

- For general purpose switching applications

RFQ

[Request For Quotation](#)

PART CODE GUIDE

SOD123	4148W	S	T4
1	2	3	4

- 1) **SOD123**: SMD Small Signal Fast Switching diodes, 2 pads, SOD-123 series code
- 2) **4148W**: Type Code for original part number 1N4148W T4
- 3) **S**: Package code, Tape/reel, 3000pcs/reel.
- 4) **T4**: Marking code for "T4" on the case surface, Different Marking for different specification.

SMD FAST SWITCHING DIODES SOD123 SERIES

DIMENSION (Unit: Inch/mm)

Image for reference



Marking: T4

SOD-123

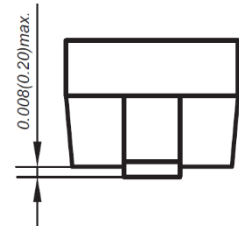
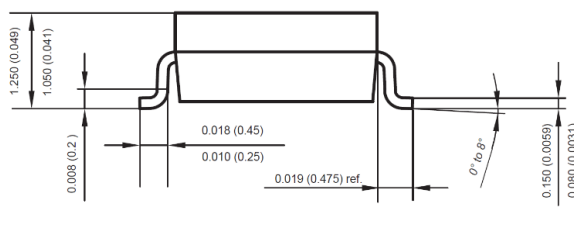
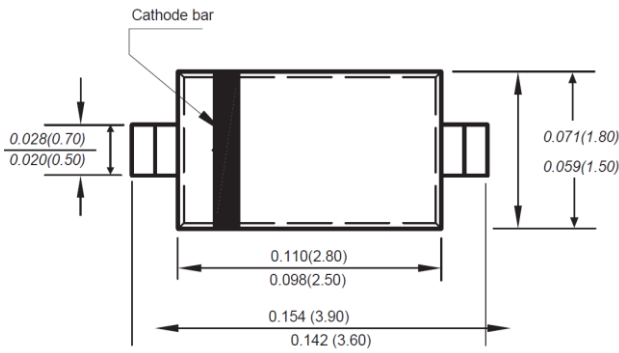

Recommend Pad Layout

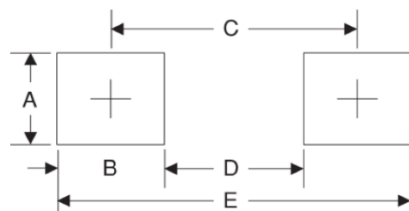

Symbol	Unit (inch)	Unit (mm)
A	0.047	1.20
B	0.047	1.20
C	0.126	3.20
D	0.079	2.00
E	0.173	4.40

SMD FAST SWITCHING DIODES SOD123 SERIES
MECHANICAL DATA

Case	Terminals	Polarity	Mounting Position	Weight per piece
JEDEC SOD-123 molded plastic body	Solder plated, Solderable per MIL-STD-750, Method 2026	Polarity symbol marking on case	Any	0.0007 Ounce, 0.0021 grams

ABSOLUTE MAX. RATING AT 25 °C

Parameter	SYMBOLS	VALUE			UNITS
		Min.	Typical	Max.	
Repetitive peak reverse voltage	V _{RRM}			100	Volts
RMS voltage	V _{RMS}			75	Volts
Forward continuous current	I _{FM}			150	mA
Non-repetitive Peak Forward Surge Current @=1.0 s @1.0µs	I _{FSM}			1.0 2.0	A
Power Dissipation	P _{tot}			400	mW
Thermal resistance junction to ambient	R _{QA}			250	°C/W
Operating Junction temperature range	T _J	-65		+150	°C
Storage temperature range	T _{STG}	-65		+150	°C

CHARACTERISTICS at Ta= 25 °C

Parameter	SYMBOLS	VALUE			UNIT	Condition
		Min.	Typ.	Max.		
Forward Voltage	V _{F1}			0.720	V	I _F = 10 µA
	V _{F2}			0.855	V	I _F = 5 mA
	V _{F3}			1.00	V	I _F = 100 mA
	V _{F4}			1.25	V	I _F 150 mA
Reverse Current	I _{R1}			25	nA	at V _R = 20 V, T _j = 25°C
	I _{R2}			1.0	µA	at V _R = 75 V, T _j = 25°C
Junction Capacitance	C _{tot}		2		pF	
Reverse Breakdown Voltage	V _{(BR)R}			75	V	at I _R =1µ
Reverse recovery time	t _{rr}			4	ns	

SMD FAST SWITCHING DIODES SOD123 SERIES

RELIABILITY

Number	Experiment Items	Experiment Method And Conditions	Reference Documents
1	Solder Resistance Test	Test 260°C± 5°C for 10 ± 2 sec. Immerse body into solder 1/16" ± 1/32"	MIL-STD-750D METHOD-2031.2
2	Solderability Test	230°C ±5°C for 5 sec.	MIL-STD-750D METHOD-2026.1 0
3	Pull Test	1 kg in axial lead direction for 10 sec.	MIL-STD-750D METHOD-2036.4
4	Bend Test	0.5Kg Weight Applied To Each Lead, Bending Arcs 90 °C ± 5 °C For 3 Times	MIL-STD-750D METHOD-2036.4
5	High Temperature Reverse Bias Test	TA=100°C for 1000 Hours at VR=80% Rated VR	MIL-STD-750D METHOD-1038.4
6	Forward Operation Life Test	TA=25°C Rated Average Rectified Current	MIL-STD-750D METHOD-1027.3
7	Intermittent Operation Life Test	On state: 5 min with rated IRMS Power Off state: 5 min with Cool Forced Air. On and off for 1000 cycles.	MIL-STD-750D METHOD-1036.3
8	Pressure Cooker Test	15 PSIG, TA=121°C, 4 hours	MIL-S-19500 APPENOIXC
9	Temperature Cycling Test	-55°C~+125°C; 30 Minutes For Dwelled Time 5 minutes for transferred time. Total: 10 cycles.	MIL-STD-750D METHOD-1051.7
10	Thermal Shock Test	0°C for 5 minutes., 100°C for 5minutes, Total: 10 cycles	MIL-STD-750D METHOD-1056.7
11	Forward Surge Test	8.3ms Single Sale Sine-wave One Surge.	MIL-STD-750D METHOD-4066.4
12	Humidity Test	TA=65°C, RH=98% for 1000 hours.	MIL-STD-750D METHOD-1021.3
13	High Temperature Storage life Test	150°C for 1000 Hours	MIL-STD-750D METHOD-1031.5

SMD FAST SWITCHING DIODES SOD123 SERIES

SUGGESTED REFLOW PROFILE (For Reference Only)

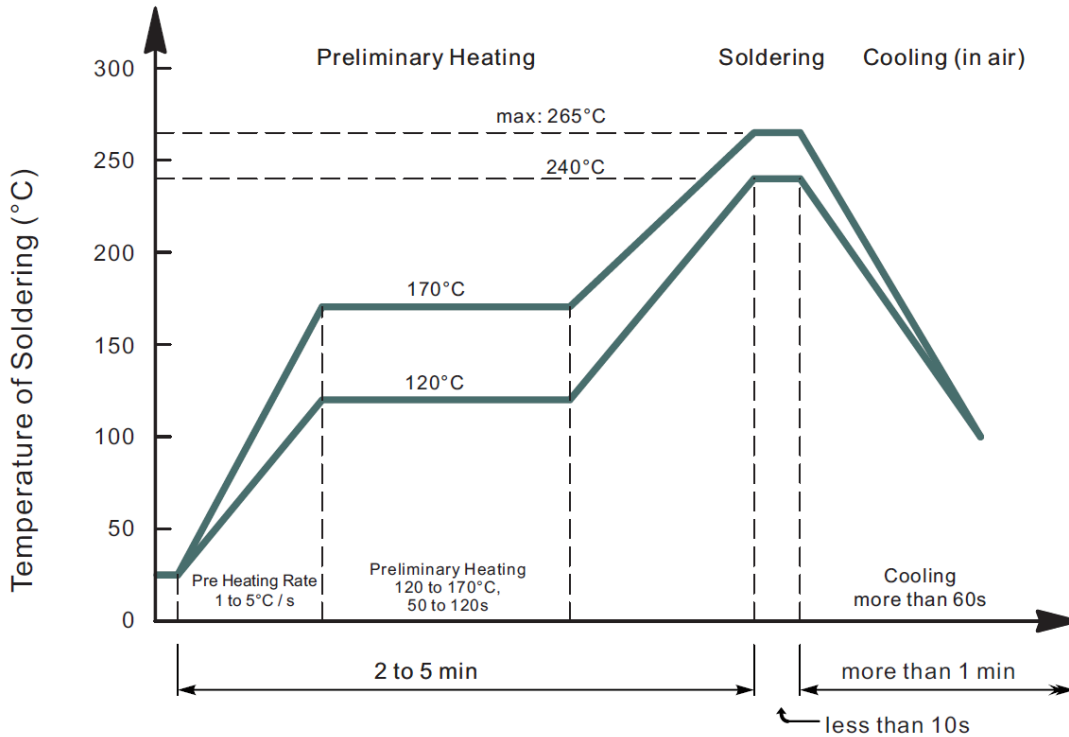

- Recommended peak temperature is over 245°C, If peak temperature is below 245 °C, you may adjust the following parameters; time length of peak temperature (longer), time length of soldering (longer), thickness of solder paste (thicker)
- Welding shall not exceed 2 times
- Remark: lead free solder paste (96.5 sn/3.0 Ag/0.5Cu)

SMD FAST SWITCHING DIODES SOD123 SERIES

RATINGS AND CHARACTERISTIC CURVES (For Reference Only)

FIG. 1- POWER DERATING CURVE

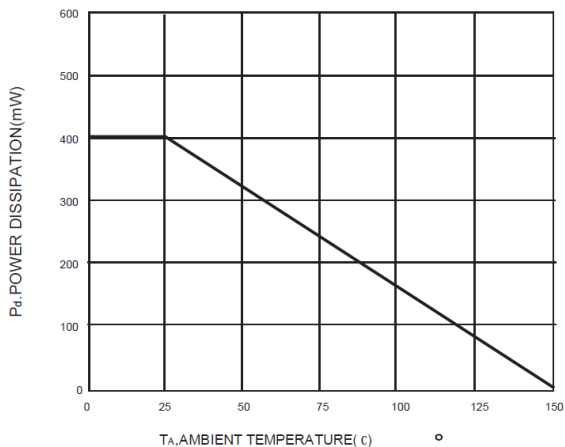

FIG. 2-TYPICAL FORWARD CHARACTERISTICS

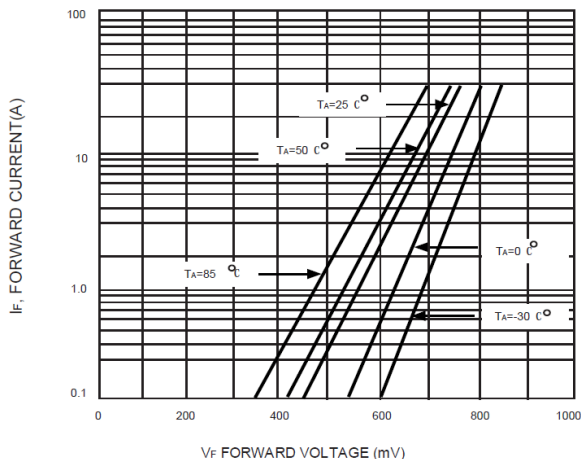

FIG. 3- TYPICAL REVERSE CHARACTERISTICS

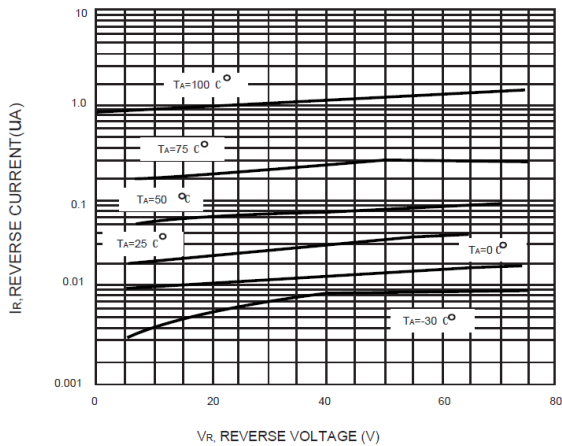

FIG. 4- REVERSE RECOVERY TIME VS FORWARD CURRENT

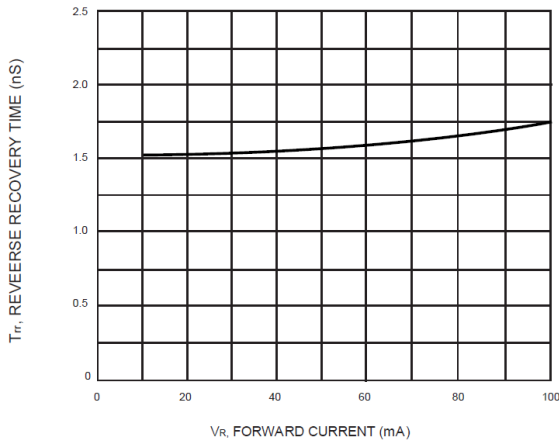
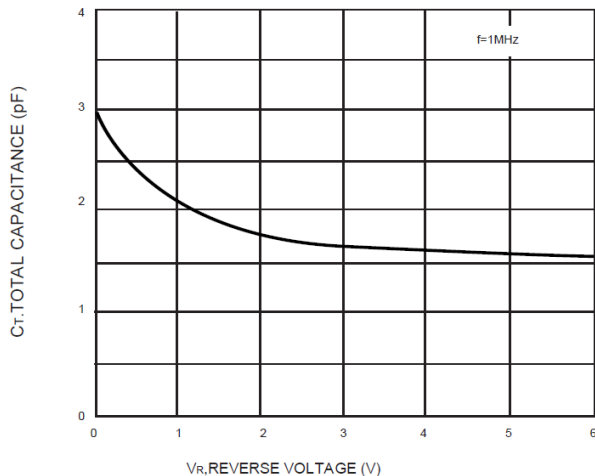

FIG. 5- TOTAL CAPACITANCE VS REVERSE VOLTAGE



SMD FAST SWITCHING DIODES SOD123 SERIES

TAPE/REEL (Unit: mm)

All Devices are packed in accordance with EIA standard RS-481-A and specifications.

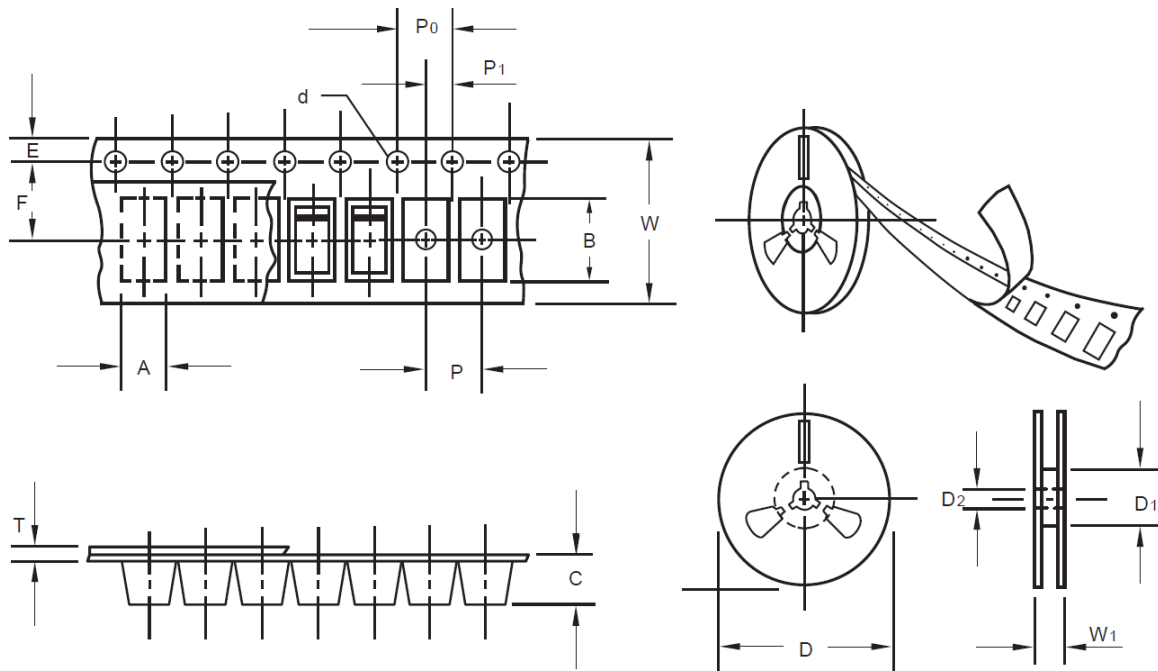

Item	Symbol	Tolerance	SO-123
Carrier width	A	0.1	2.10
Carrier Length	B	0.1	4.00
Carrier Depth	C	0.1	1.60
Sprocket hole	d	0.05	1.55
13" Reel outside diameter	-	-	-
13" Reel inner diameter	-	-	-
7" Reel outside diameter	D	2.0	178.00
7" Reel inner diameter	D1	Min.	50.00
Feed hole diameter	D2	0.5	13.00
Sprocket hole position	E	0.1	1.75
Punch hole position	F	0.1	3.50
Punch hole pitch	P	0.1	4.00
Sprocket hole pitch	P0	0.1	4.00
Embossment center	P1	0.1	2.00
Overall tape thickness	T	0.1	0.25
Tape width	W	0.3	8.15
Reel width	W1	1.0	10.50

SMD FAST SWITCHING DIODES SOD123 SERIES

PACKAGE

Case Code	Reel Size	MPQ (pcs)	Component Spacing (mm)	Qty. Per Box (pcs)	Inner Box L*W*H (mm)	Reel Size (mm)	Carton size L*W*H (mm)	Qty. Per Carton (pcs)	G. W (kg)
SOD-123	7"	3,000	-	24,000	210*208*203	178	400*400*250	180,000	9.0

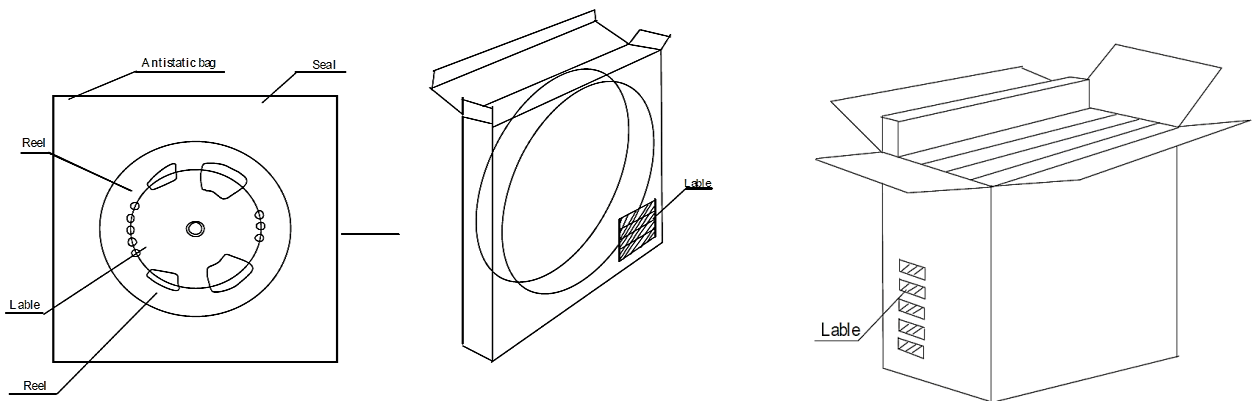

DISCLAIMER

NextGen Component, Inc. reserves the right to make changes to the product(s) and or information contained herein without notice. No liability is assumed as a result of their use or application. No rights under any patent accompany the sale of any such product(s) or information