



**SPECIFICATION SHEET**

<b>SPECIFICATION SHEET NO.</b>	Q1213- SOD323148WSST4	
<b>DATE</b>	Dec. 13, 2023	
<b>REVISION</b>	A1	Updated With Most Recent Data
<b>DESCRIPTION AND MAIN PARAMETRICS</b>	<p>SMD Small Signal Fast Switching diodes, SOD-323 series, 2 pads, Type 1N4148WS; Repetitive Peak Reverse Voltage(V RRM) 100V Max.            Current - Average Rectified (Io): 150mA.            Capacitance Between Terminals: 2pF@VR=0V, f=1.0MHz            Operating Temp. Range -55°C ~+150°C, Package in Tape/Reel, 3000pcs/Reel            RoHS/RoHS III compliant, RoHS Annex III lead Exemption            (Exempt per RoHS EU 2015/863)</p>	
<b>CUSTOMER</b>		
<b>CUSTOMER PART NO.</b>		
<b>CROSS REF. PART NO.</b>		
<b>ORIGINAL MFG/PART NO.</b>	MDD Diodes/1N4148WS	
<b>PART CODE</b>	SOD323148WSST4	

<b>VENDOR APPROVE</b>			
Issued/Checked/Approved			
DATE: Dec. 13, 2023			

<b>CUSTOMER APPROVE</b>	
DATE:	

**SMD FAST SWITCHING DIODES SOD323 SERIES**

**MAIN FEATURE**

- Fast Switching Speed
- Surface Mount Package Ideally Suited For Automatic Insertion
- High Conductance
- Cross Competitors Parts and More.
- RoHS/RoHS III compliant, RoHS Annex III lead Exemption (Exempt per RoHS EU 2015/863)



**APPLICATION**

- For general purpose switching applications

**ELECTRICAL CHARACTERISTICS**

See Page 4~ Page 5

**HOW TO ORDER**

Please follow up Part Code Guide and indicate pat code when you order or RFQ.

**PART CODE GUIDE**

**RFQ**  
[Request For Quotation](#)

SOD323	148WS	S	T4
1	2	3	4

1. SOD323: SMD Small Signal Fast Switching diodes, 2 pads, SOD-323 series code
2. 148WS: Type Code for original part number 1N4148WS
3. S: Package code, Tape/reel, 3000pcs/reel.
4. T4: Marking code for "T4" on the case surface, Different Marking for different specification.

**SMD FAST SWITCHING DIODES SOD323 SERIES**

**DIMENSION (Unit: Inch/mm)**

Image for reference



Marking: T4

SOD-323

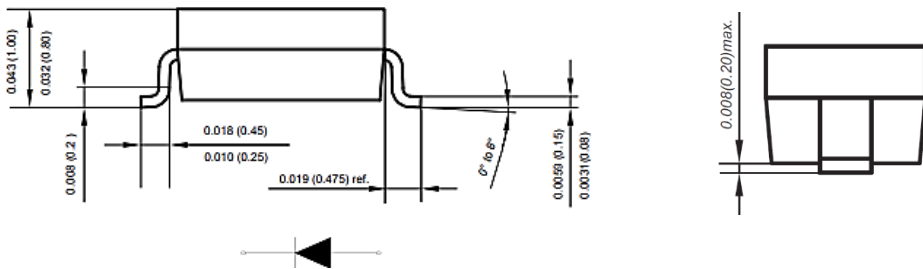
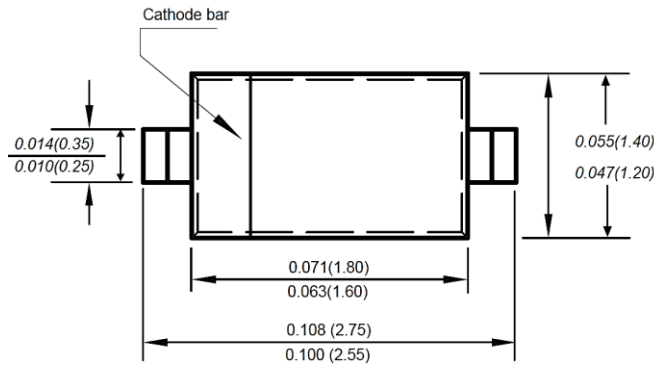

Recommend  
Pad Layout

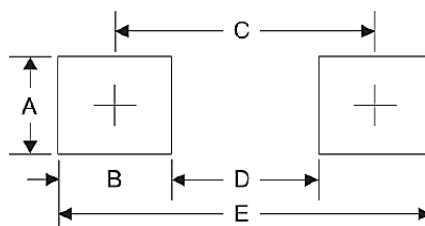

Symbol	Unit (inch)	Unit (mm)
A	0.028	0.70
B	0.028	0.70
C	0.085	2.15
D	0.071	1.80
E	0.112	2.85

**SMD FAST SWITCHING DIODES SOD323 SERIES**
**MECHANICAL DATA**

CASE	TERMINALS	POLARITY	MOUNTING POSITION	WEIGHT PER PIECE
JEDEC SOD-323 Molded Plastic Body	Solder Plated, Solderable Per MIL-STD-750, Method 2026	Polarity Symbol Marking On Case	Any	0.0007 Ounce, 0.0021 grams

**ABSOLUTE MAX. RATING AT 25 °C**

PARAMETER	SYMBOLS	VALUE			UNITS
		MIN.	TYPICAL	MAX.	
Repetitive Peak Reverse Voltage	V <sub>RRM</sub>			100	Volts
RMS Voltage	V <sub>RMS</sub>			75	Volts
Reverse Breakdown Voltage at I <sub>R</sub> = 1.0μA	V (BR)R			75	Volts
Forward Continuous Current	I <sub>FM</sub>			300	mA
Rectified Output Current	I <sub>o</sub>	150 (Average)			mA
Peak Forward Current	@1s	I <sub>FSM</sub>		0.5	A
	@1 ms			1.0	
	@1 us			4.0	
Power Dissipation	P <sub>d</sub>			400	mW
Thermal Resistance Junction To Ambient	R <sub>QJA</sub>			250	°C/W
Operating Junction Temperature Range	T <sub>J</sub>	-55		+150	°C
Storage Temperature Range	T <sub>STG</sub>	-55		+150	°C

**SMD FAST SWITCHING DIODES SOD323 SERIES**
**CHARACTERISTICS AT TA= 25 °C**

PARAMETER	SYMBOLS	VALUE			UNIT	CONDITION
		MIN.	TYP.	MAX.		
Forward Voltage	V F1			0.715	V	I F= 1.0mA
	V F2			0.855	V	IF= 10 mA
	V F3			1.0	V	IF = 50 mA
	V F4			1.25	V	IF 150mA
Reverse Current	I R1			0.025	μA	at VR= 20V, Tj= 25°C
	I R2			1.0	μA	at VR= 75V, Tj= 25°C
	I R3			30	μA	at VR= 25V, Tj= 150°C
	I R4			50	μA	at VR= 75V, Tj= 150°C
Capacitance Between Terminals	C tot			2	pF	VR=0V, f=1.0MHz
Reverse Recovery Time	t rr			4	ns	IF=IR=10mA Irr=0.1*IR, RL=100Ω

**SMD FAST SWITCHING DIODES SOD323 SERIES**
**RELIABILITY**

NUMBER	EXPERIMENT ITEMS	EXPERIMENT METHOD AND CONDITIONS	REFERENCE DOCUMENTS
1	Solder Resistance Test	Test 260°C± 5°C for 10 ± 2 sec. Immerse body into solder 1/16" ± 1/32"	MIL-STD-750D METHOD-2031.2
2	Solderability Test	230°C ±5°C for 5 sec.	MIL-STD-750D METHOD-2026.1 0
3	Pull Test	1 kg in axial lead direction for 10 sec.	MIL-STD-750D METHOD-2036.4
4	Bend Test	0.5Kg Weight Applied To Each Lead, Bending Arcs 90 °C ± 5 °C For 3 Times	MIL-STD-750D METHOD-2036.4
5	High Temperature Reverse Bias Test	TA=100°C for 1000 Hours at VR=80% Rated VR	MIL-STD-750D METHOD-1038.4
6	Forward Operation Life Test	TA=25°C Rated Average Rectified Current	MIL-STD-750D METHOD-1027.3
7	Intermittent Operation Life Test	On state: 5 min with rated IRMS Power Off state: 5 min with Cool Forced Air. On and off for 1000 cycles.	MIL-STD-750D METHOD-1036.3
8	Pressure Cooker Test	15 PSIG, TA=121°C, 4 hours	MIL-S-19500 APPENOIXC
9	Temperature Cycling Test	-55°C~+125°C; 30 Minutes For Dwelled Time 5 minutes for transferred time. Total: 10 cycles.	MIL-STD-750D METHOD-1051.7
10	Thermal Shock Test	0°C for 5 minutes., 100°C for 5minutes, Total: 10 cycles	MIL-STD-750D METHOD-1056.7
11	Forward Surge Test	8.3ms Single Sale Sine-wave One Surge.	MIL-STD-750D METHOD-4066.4
12	Humidity Test	TA=65°C, RH=98% for 1000 hours.	MIL-STD-750D METHOD-1021.3
13	High Temperature Storage life Test	150°C for 1000 Hours	MIL-STD-750D METHOD-1031.5

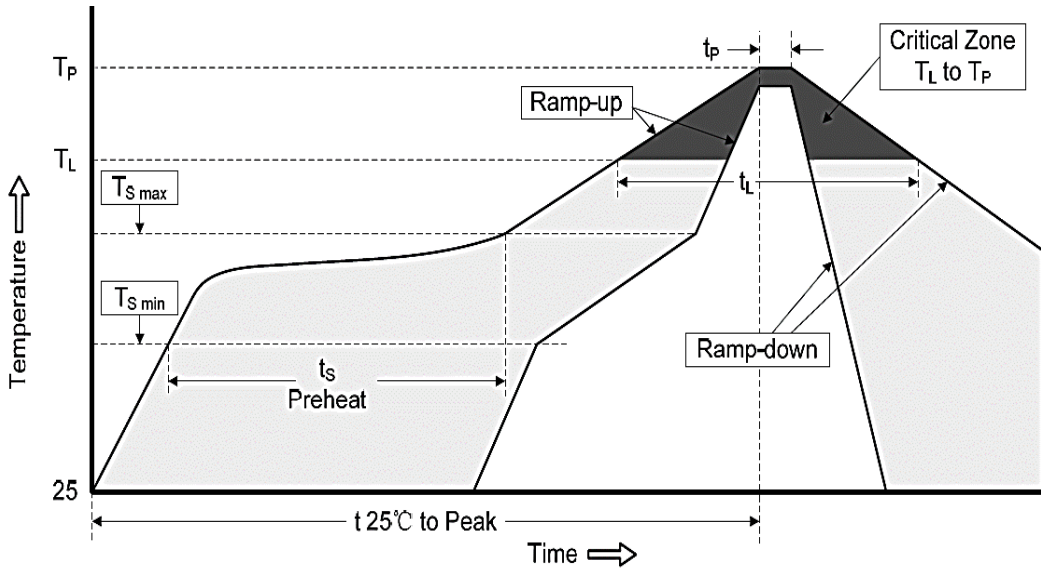
**SMD FAST SWITCHING DIODES SOD323 SERIES**
**SUGGESTED REFLOW PROFILE (For Reference Only)**

PROFILE FEATURE		PB-FREE ASSEMBLY
Average Ramp-up Rate (Ts Max to Tp)		3°C/second Max
Preheat	Temperature Min (Ts Min.)	150°C
	Temperature Max (Ts Max.)	200°C
	Time (ts Min. to ts Max.)	60 ~ 180 seconds
Time maintained above	Temperature (TL)	217°C
	Time (tl)	60 ~ 150 seconds
Peak/Classification Temperature (Tp)		260 °C
Time within 5°C of actual Peak Temperature (tp)		20 ~ 40 seconds
Ramp-down rate		6 °C /Second Max.
Time 25 °C to Peak Temperature		8 minutes Max.
Suggest reflow times		3 Times Max.

**SMD FAST SWITCHING DIODES SOD323 SERIES**

**RATINGS AND CHARACTERISTIC CURVES** (For Reference Only)

Fig.1 Forward Current Derating Curve

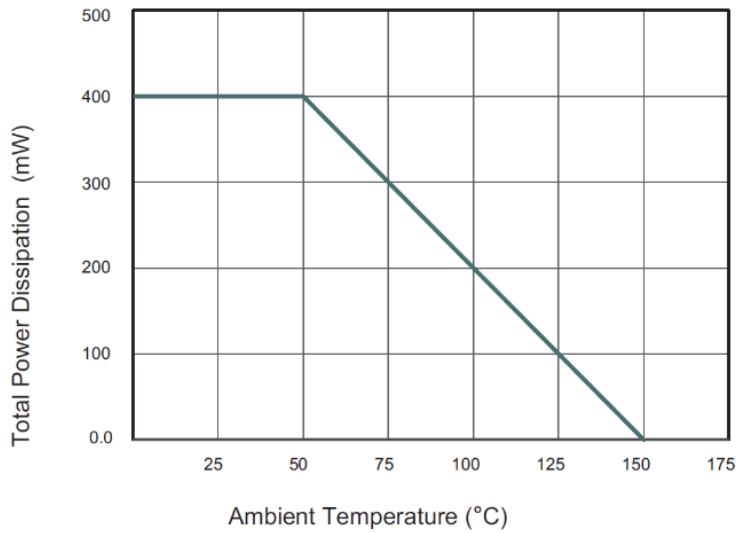
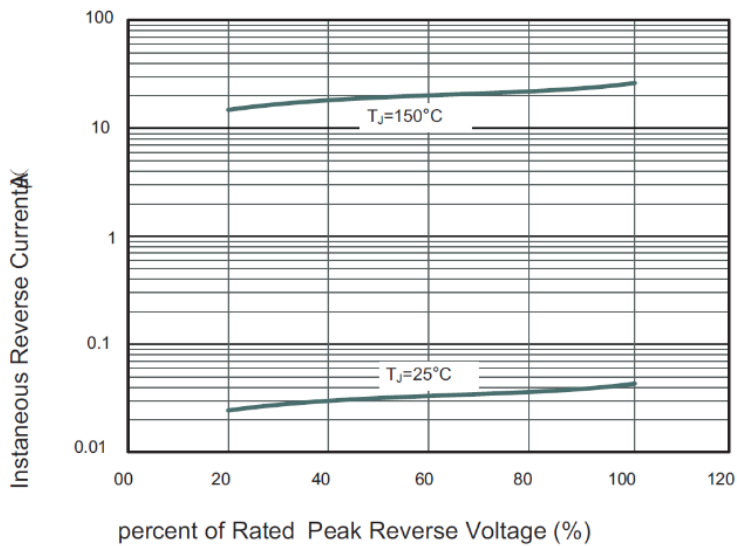

Fig.2 Typical Reverse Characteristics





**SMD FAST SWITCHING DIODES SOD323 SERIES**

**RATINGS AND CHARACTERISTIC CURVES** (For Reference Only)

Fig.3 Typical Instaneous Forward

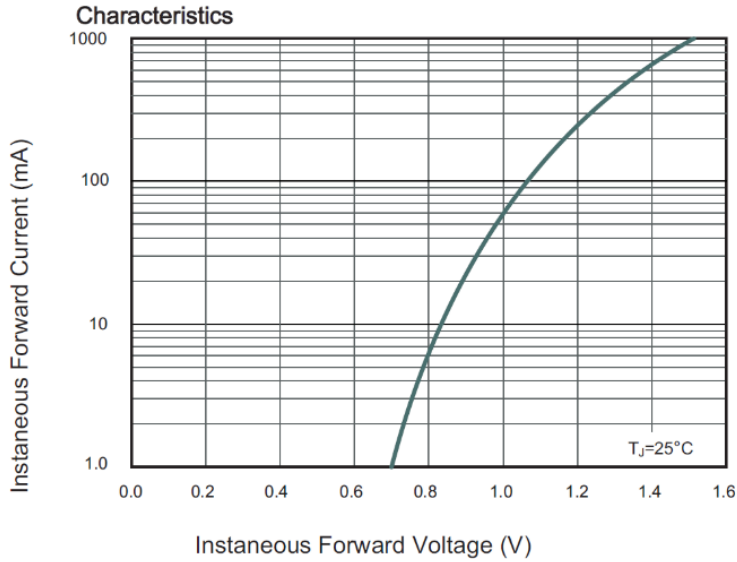
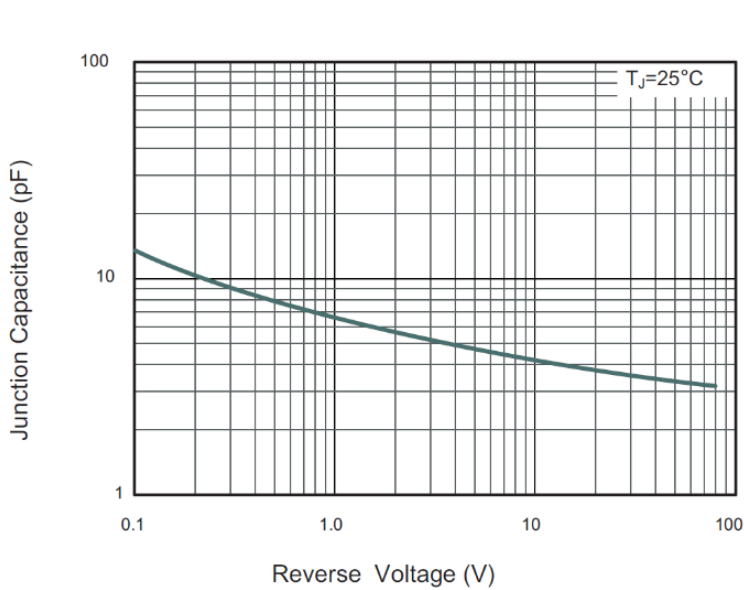
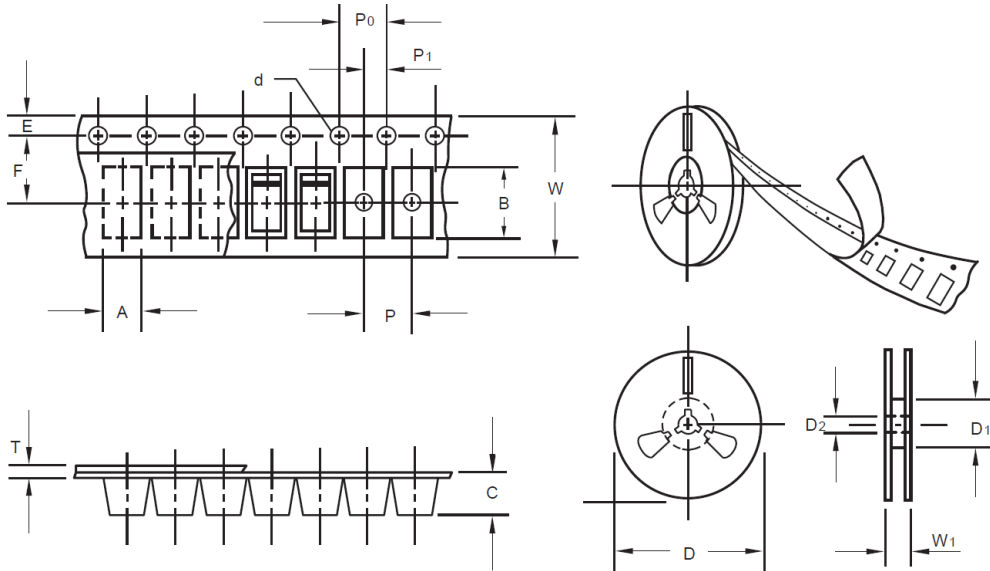

Fig.4 Typical Junction Capacitance



**SMD FAST SWITCHING DIODES SOD323 SERIES**
**TAPE/REEL (Unit: mm) (For Reference Only)**

All Devices are packed in accordance with EIA standard RS-481-A and specifications.



Item	Symbol	Tolerance	SO-323
Carrier width	A	0.1	2.10
Carrier Length	B	0.1	4.00
Carrier Depth	C	0.1	1.60
Sprocket hole	d	0.05	1.55
13"Reel outside diameter	-	-	-
13"Reel inner diameter	-	-	-
7"Reel outside diameter	D	2.0	178.0
7"Reel inner diameter	D1	Min.	50.00
Feed hole diameter	D2	0.5	13.00
Sprocket hole position	E	0.1	1.75
Punch hole position	F	0.1	3.50
Punch hole pitch	P	0.1	4.00
Sprocket hole pitch	P0	0.1	4.00
Embossment center	P1	0.1	2.00
Overall tape thickness	T	0.1	0.25
Tape width	W	0.3	8.15
Reel width	W1	1.0	10.50
Qty./Reel (pcs)	3000		

## SMD FAST SWITCHING DIODES SOD323 SERIES

### IMPORTANT NOTES AND DISCLAIMER

1. RoHS Compliance: The levels of RoHS restricted materials in this product are below the maximum concentration values (also referred to as the threshold limits) permitted for such substances, or are used in an exempted application, in accordance with EU RoHS Directive (EU) 2015/863 EC (RoHS3). RoHS Test Report for this product can be obtained at Download Center.
2. REACH Compliance: REACH substances of high concern (SVHCs) information is available for this product. Since the European Chemical Agency (ECHA) has published notice of their intent to frequently revise the SVHC listing for the foreseeable future, REACH Test Report for this product can be obtained at Download Center.
3. All Product parametric performance is indicated in the Electrical Characteristics for the listed herein test conditions, unless otherwise noted. Product performance may not be indicated by the Electrical Characteristics if operated under different conditions.
4. NextGen Component, Inc (*NextGen*) reserves the right to make changes to this document and its products and specifications at any time without notice. Customers should obtain and confirm the latest product information and specifications before final design, purchase or use.
5. *NextGen* makes no warranty, representation or guarantee regarding the suitability of its products for any particular purpose, not does NextGen assume any liability for application assistance or customer product design.
6. *NextGen* does not warrant or accept any liability with products which are purchased or used for any unintended or unauthorized application. No license is granted by implication or otherwise under any intellectual property rights of *NextGen*.
7. *NextGen* products are not authorized for use as critical components in life support devices or systems without express written approval by *NextGen*.
8. *NextGen* requires that customers first obtain an RMA (Returned Merchandise Authorization) number prior to returning any products. Returns must be made within 30 days of the date of invoice, be in the original packaging, unused and like-new condition. At the time of quoting or purchasing, a product may say that it is Non-Cancelable/ Non-Returnable (NCNR). These products are not returnable and not refundable.