



**SPECIFICATION SHEET**

<b>SPECIFICATION SHEET NO.</b>	N0310-DO41FR1070A10A
<b>DATE</b>	Mar. 10, 2021
<b>REVISION</b>	A0
<b>DESCRIPTION</b>	<p>Axial Lead Fast Recovery Rectifier, DO-41 series, FR107 Type 2 Pins</p> <p>Reverse Voltage 1000V Max. Forward Current 1.0A Max.</p> <p>Operating Temp. Range -65°C ~+150°C</p> <p>Package in AMMO Pack, 5000pcs/Tape, Tape/Box</p> <p>RoHS/RoHS III compliant</p>
<b>CUSTOMER</b>	
<b>CUSTOMER PART NUMBER</b>	
<b>CROSS REF. PART NUMBER</b>	
<b>ORIGINAL PART NUMBER</b>	MDD FR107
<b>PART CODE</b>	DO41FR1070A10A

<b>VENDOR APPROVE</b>			
Issued/Checked/Approved			
DATE: March 10, 2021			

<b>CUSTOMER APPROVE</b>
DATE:

**AXIAL LEAD FAST RECOVERY RECTIFIERS DO-41 SERIES**

**MAIN FEATURE**



- The plastic package carries Underwriters Laboratory Flammability Classification 94V-0
- Fast switching for high efficiency
- High forward surge current capability
- High temperature soldering guaranteed, 250 °C/10 seconds at terminals
- Low reverse leakage

**APPLICATION**

- For printed circuit board

**RFQ**

[Request For Quotation](#)

**PART CODE GUIDE**

DO41	FR1070	A	10A
1	2	3	4

- 1) **DO41**: Axial Lead Fast Recovery Rectifier, 2 Pins, DO-41 series
- 2) **FR1070**: Type code for original part number FR107
- 3) **A**: Package code, Package in AMMO Pack, 5000pcs/Tape, Tape/Box
- 4) **10A**: Specification code for Reverse Voltage 1000V Max. Forward Current 1.0A Max.

**MORE ITEMS AVAILABLE**

DO41FR1070A10A				

**AXIAL LEAD FAST RECOVERY RECTIFIERS DO-41 SERIES**

**DIMENSION (Unit: Inch/mm)**

Image for reference



Marking: FR107

DO-41

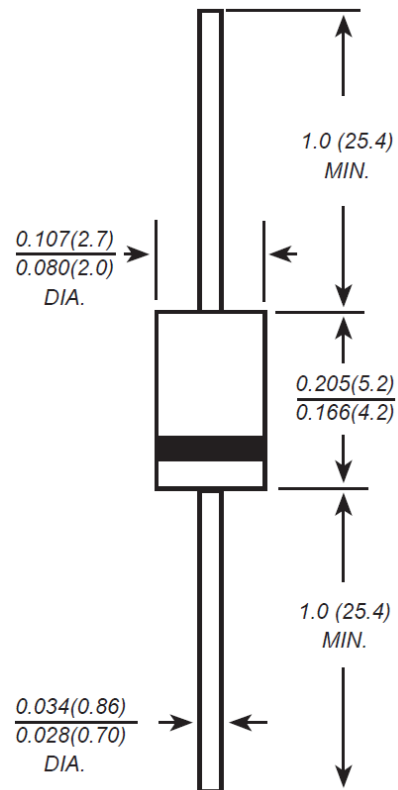

**AXIAL LEAD FAST RECOVERY RECTIFIERS DO-41 SERIES**
**MECHANICAL DATA**

Case	Terminals	Polarity	Mounting Position	Weight per piece
JEDEC DO-41 molded plastic body	Solder plated, Solderable per MIL-STD-750, Method 2026	Polarity symbol marking on case	Any	0.012 Ounce, 0.373 grams

**MAX. RATING & CHARACTERISTICS**

Parameter	SYMBOLS	VALUE			UNITS
		Min.	Typical	Max.	
Repetitive peak reverse voltage	V <sub>RRM</sub>			1000	Volts
RMS voltage	V <sub>RMS</sub>			700	Volts
DC blocking voltage	V <sub>DC</sub>			1000	Volts
Average forward output rectified current at TL= 75°C	I <sub>AV</sub>			1.0	A
Peak forward surge current 8.3ms single half sine-wave superimposed on rated load (JEDEC Method)	I <sub>FSM</sub>		30		A
Instantaneous forward voltage at 1.0A	V <sub>F</sub>			1.30	Volts
DC reverse current at rated DC blocking voltage	I <sub>R</sub>	TA=25°C		5	μA
		TA=100°C		50	μA
Reverse recovery Time (Note 2)	t <sub>rr</sub>			500	ns
Junction capacitance (Note 3)	C <sub>J</sub>		15		pF
Thermal resistance (Note 4)	R <sub>QJA</sub>		50		°C/W
Operating junction temperature range	T <sub>J</sub>	-65		+150	°C
Storage temperature range	T <sub>STG</sub>	-65		+150	°C

**Note**

- Ratings at 25 C ambient temperature unless otherwise specified. Single phase half-wave 60Hz, resistive or inductive load, for capacitive load current derate by 20%.
- Reverse recovery condition IF=0.5A,IR=1.0A,Irr=0.25A
- Measured at 1.0MHz and applied reverse voltage of 4.0Voltage
- Thermal resistance from junction to ambient at 0.375"(9.5mm)lead length, PCB. Mounted.

**AXIAL LEAD FAST RECOVERY RECTIFIERS DO-41 SERIES**
**RELIABILITY**

Number	Experiment Items	Experiment Method And Conditions	Reference Documents
1	Solder Resistance Test	Test 260°C± 5°C for 10 ± 2 sec. Immerse body into solder 1/16" ± 1/32"	MIL-STD-750D METHOD-2031.2
2	Solderability Test	230°C ±5°C for 5 sec.	MIL-STD-750D METHOD-2026.1 0
3	Pull Test	1 kg in axial lead direction for 10 sec.	MIL-STD-750D METHOD-2036.4
4	Bend Test	0.5Kg Weight Applied To Each Lead, Bending Arcs 90 °C ± 5 °C For 3 Times	MIL-STD-750D METHOD-2036.4
5	High Temperature Reverse Bias Test	TA=100°C for 1000 Hours at VR=80% Rated VR	MIL-STD-750D METHOD-1038.4
6	Forward Operation Life Test	TA=25°C Rated Average Rectified Current	MIL-STD-750D METHOD-1027.3
7	Intermittent Operation Life Test	On state: 5 min with rated IRMS Power Off state: 5 min with Cool Forced Air. On and off for 1000 cycles.	MIL-STD-750D METHOD-1036.3
8	Pressure Cooker Test	15 PSIG, TA=121°C, 4 hours	MIL-S-19500 APPENOIXC
9	Temperature Cycling Test	-55°C~+125°C; 30 Minutes For Dwelled Time 5 minutes for transferred time. Total: 10 cycles.	MIL-STD-750D METHOD-1051.7
10	Thermal Shock Test	0°C for 5 minutes., 100°C for 5minutes, Total: 10 cycles	MIL-STD-750D METHOD-1056.7
11	Forward Surge Test	8.3ms Single Sale Sine-wave One Surge.	MIL-STD-750D METHOD-4066.4
12	Humidity Test	TA=65°C, RH=98% for 1000 hours.	MIL-STD-750D METHOD-1021.3
13	High Temperature Storage life Test	150°C for 1000 Hours	MIL-STD-750D METHOD-1031.5

# AXIAL LEAD FAST RECOVERY RECTIFIERS DO-41 SERIES

## RATINGS AND CHARACTERISTIC CURVES (For Reference Only)

AVERAGE FORWARD RECTIFIED CURRENT  
AMPERES

FIG. 1- FORWARD CURRENT DERATING CURVE

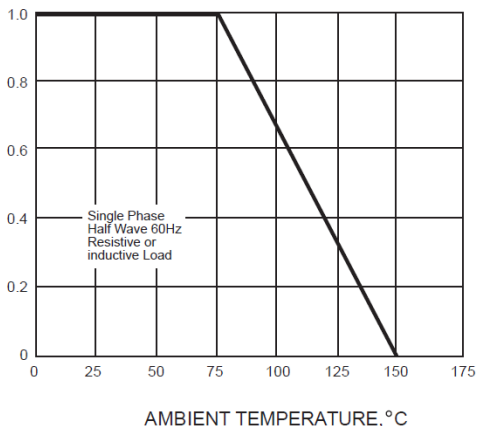

PEAK FORWARD SURGE CURRENT,  
AMPERES

FIG. 2-MAXIMUM NON-REPETITIVE PEAK FORWARD SURGE CURRENT

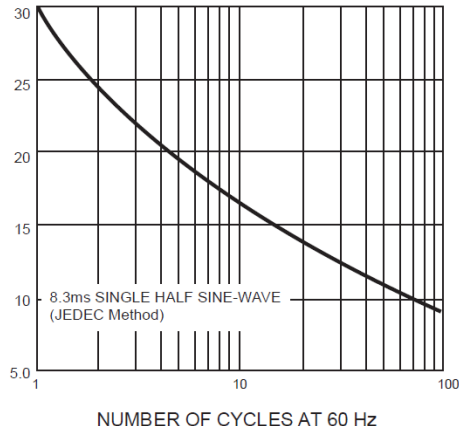

INSTANTANEOUS FORWARD  
CURRENT, AMPERES

FIG. 3-TYPICAL INSTANTANEOUS FORWARD CHARACTERISTICS

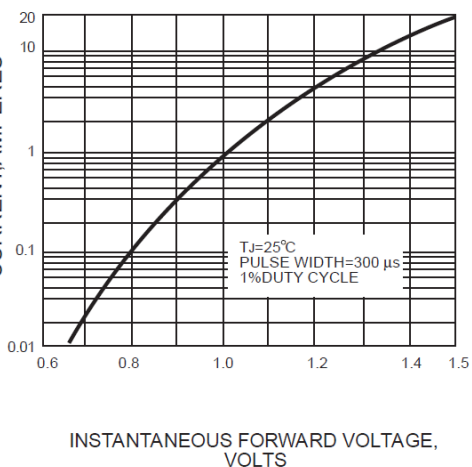

INSTANTANEOUS REVERSE CURRENT,  
MICROAMPERES

FIG. 4-TYPICAL REVERSE CHARACTERISTICS

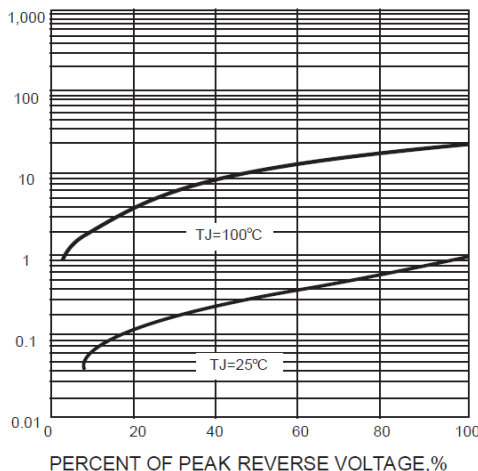

JUNCTION CAPACITANCE, pF

FIG. 5-TYPICAL JUNCTION CAPACITANCE

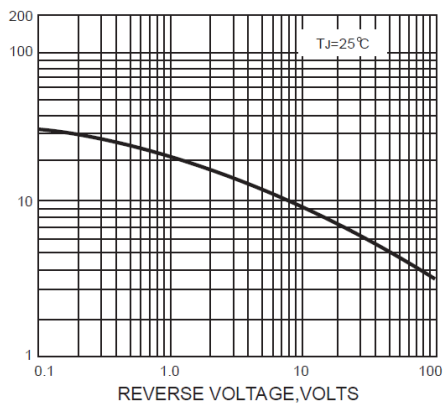

TRANSIENT THERMAL IMPEDANCE,  
°C/W

FIG. 6-TYPICAL TRANSIENT THERMAL IMPEDANCE

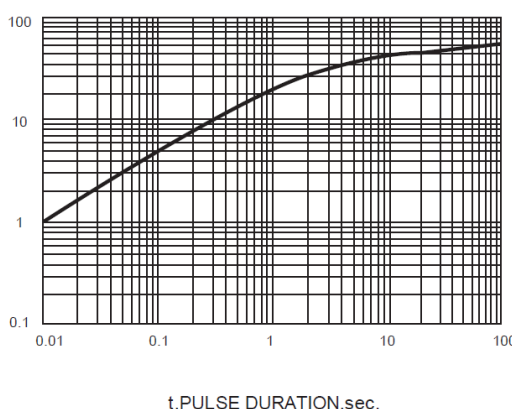

**AXIAL LEAD FAST RECOVERY RECTIFIERS DO-41 SERIES**

**AMMO BOX (Unit: mm)**

- All Devices are packed in accordance with EIA standard RS-296-D and specifications.
- Each component lead shall be sandwiched between taps for A minimum of 3.2 mm (-.126")

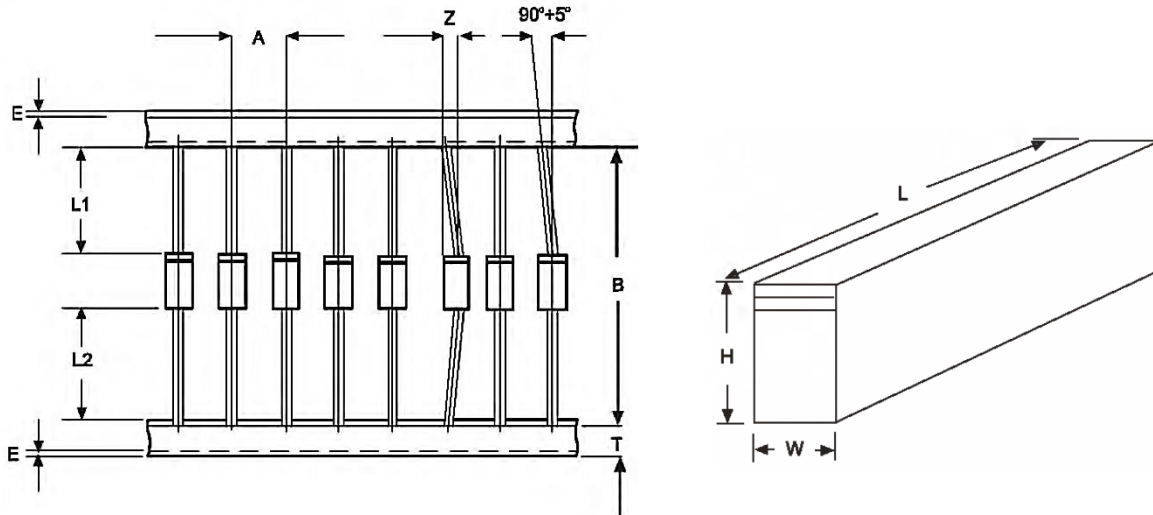

Item	Symbol	DO-41 Uni(mm)	DO-41 Unit (Inch)
Component Alignment	Z	1.2 Max.	0.048 Max.
Tape Width	T	6.0 +/- 0.4	0.236 +/- 0.016
Exposed Adhesive	E	0.8 Max.	0.032 Max.
Body Eccentricity	L1 – L2	1.0 Max.	0.040 Max.
Component Pitch A (2.0mm/20 pitch)	A	5.0	0.197
Component Pitch B (2.0mm/20 pitch)	B	26.0	1.023
Component Pitch A (2.0mm/10 pitch)	A	5.0	0.197
Component Pitch B (2.0mm/10 pitch)	B	52.4	2.063
Box Length	L	255.0 +/- 5.0	10.04 +/- 0.197
Box Width	W	78.0 +/- 5.0	3.07 +/- 0.197
Box Height	H	150.0 +/- 5.0	5.91 +/- 0.197

**AXIAL LEAD FAST RECOVERY RECTIFIERS DO-41 SERIES**

**AMMO PACK IN TAPE/BOX (Unit: mm)**

Case Code	Qty. Per Reel (pcs)	Component Space (mm)	Tape Space (mm)	Inner Box L*W*H (mm)	Carton size L*W*H (mm)	Qty. Per Carton (pcs)	G. W (kg)
DO-41	5000	5.0	52.4	198*86*21	450*215*250	50,000	12.45

**DISCLAIMER**

NextGen Component, Inc. reserves the right to make changes to the product(s) and or information contained herein without notice. No liability is assumed as a result of their use or application. No rights under any patent accompany the sale of any such product(s) or information