



DATA SHEET NO.	R0924-YT32K76800S001	
ORIGINAL MFG/PART NO	TKD Crystals/CS12K032768ADCBGE	
DATE	Sept. 24, 2024	
REVISION	A1	Updated With Most Recent Data
DESCRIPTION AND MAIN PARAMETRICS	KHz SMD Crystals, L6.90*W1.40*H1.40mm, 4 Pads, YT series 32.76800KHz, Tolerance: ±20ppm, CL 12.5pF ESR 65 KΩ Max., Operating Temp. Range -40°C ~+85°C Reflow Profile Condition 260 °C Max. Tape/Reel, 3000pcs/Reel, REACH/RoHS/RoHS III compliant	
CUSTOMER		
CUSTOMER PART NUMBER		
CROSS REF. PART NUMBER		
MEMO		

VENDOR APPROVE			
Issued/Checked/Approved			
Date: Sept. 24, 2024			

CUSTOMER APPROVE	
Date:	

MAIN FEATURE

- SMD Package, L6.90*W1.40*H1.40mm, 4 Pads
- Industry Standard
- Reflow Profile Condition 260 °C Max.
- Operating Temperature Range: -40~+85°C
- Available CL 6pF/7pF/12.5pF
- Low ESR 65kohm Max.
- Offer Quality Alternatives Parts For Major Brand and more
- Moisture Sensitivity Level (MSL) 1 (Unlimited)
- REACH/RoHS/RoHS III Compliant



MAIN APPLICATION

- Small Communications Devices And More

ELECTRICAL CHARACTERISTICS

- See Page 3 ~ Page 4 For Different Part Number.

PRODUCT IMAGE FOR REFERENCE



*Image shown is a representation only.
Exact specifications should be obtained
from the product dimension.*

HOW TO ORDER

Please follow up NextGen part code guide and indicate part code when you order or RFQ.

NEXTGEN PART CODE GUIDE

RFQ
[Request For Quotation](#)

CODE	NAME	KEY SPECIFICATION OPTION
YT	Product Index / Series	KHz SMD Crystal L6.90*W1.40*H1.40mm, 4 Pads
32K768	Frequency Range	For Frequency Range 32.76800KHz
00S	Internal Control Code	Special letter A~Z , a~z or digits (1-9)
001	Parameters code	Special Parameters Code letter A~Z, a~z or digits (1-9)

ELECTRICAL PARAMETERS – FOR DIFFERENT PART SKU CODE- Ta = 25°C

NEXTGEN PART CODE	ORIGINAL PART NUMBER	FREQUENCY RANGE	FREQUENCY TOLERANCE @ 25°C±3°C	LOAD CAPACITANCE
		KHZ	PPM	PF
YT32K76800S004	CS12K032768DDCBGE	32.768	±20	6
YT32K76800S003	CS12K032768EDCBGE	32.768	±20	7
YT32K76800S001	CS12K032768ADCBGE	32.768	±20	12.5

GENERAL ELECTRICAL PARAMETERS

PARAMETER	UNITS	VALUE			CONDITION
		MIN.	TYPICAL	MAX.	
Mode of Oscillation		AT Fundamental			
Equivalent Series Resistance (ESR)	KΩ	-	-	65	@ Series
Parabolic Coefficient	ppm/°C ²		-0.036	-	Refer to Operating Temperature
Drive Level (DL)	μW	-	0.1	-	
Shunt Capacitance (C0)	pF	-	-	3	
Insulation Resistance (IR)	MΩ	500	-	-	@DC 100V, Between terminal # 1 and terminal # 4
Operation Temperature	°C	-40	-	+85	
Storage Temperature	°C	-55	-	+125	
Aging Per Year	ppm	-5	-	+5	Frequency Deviation Refer to 25°C Frequency

DIMENSION (Unit: mm)

Top View

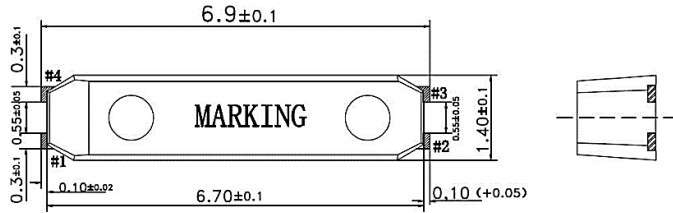

Bottom View

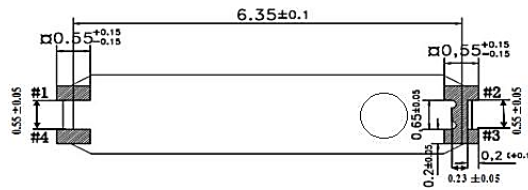

Side View

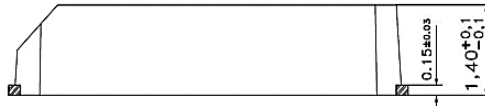

Recommended
Soldering Pattern

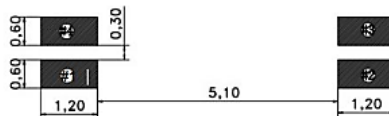

Internal Connection

Note: Do not connect #2 and #3 terminals to any external circuits (including GND).

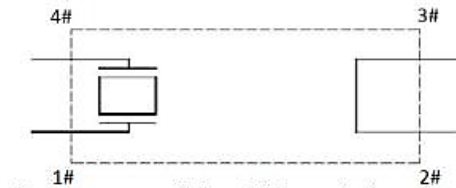

RELIABILITY

TEST ITEMS	TEST METHOD AND CONDITIONS	REQUIREMENTS
Vibration	<ol style="list-style-type: none"> Vibration Frequency: 10 to 55Hz Vibration Amplitude: 1.5mm Cycle Time: 1-2min(10-55-10Hz) Direction: X.Y.Z Duration: 2h/each direction 	Frequency Change: ± 10 ppm Max. Resistance Change: 10kohm Max.
Shock	3 Times free drop from 75cm height to hard wooden board of thickness more than 30mm	Frequency Change: ± 10 ppm Max. Resistance Change: 15kohm Max.
Hermetic Seal	Helium leak detector Checked: Before the molded crystal units	Less than $1 \times 10 \text{ EXP}(-7)$ mbar.l/sec
Weldability	Dip the leads of crystal units into the solution (7-10%) of rosin 3 \pm 1s, then dip into tank 5~10S Temperature of solder melted tank is 245 $^{\circ}$ C \pm 5 $^{\circ}$ C	The dipped surface of the leads should be at least 95% covered with continuous new solder coating.
High Temperature	96 hours at 125 $^{\circ}$ C \pm 2 $^{\circ}$ C After being left at room temperature for 2 hours, the test is carried out.	Frequency Change: ± 20 ppm Max. Resistance Change: 10kohm Max.
Low Temperature	96 hours at -40 $^{\circ}$ C \pm 2 $^{\circ}$ C After being left at room temperature for 2 hours, the test is carried out.	Frequency Change: ± 10 ppm Max. Resistance Change: 10kohm Max.
High Temperature And Humidity	96 hours at 60 $^{\circ}$ C \pm 2 $^{\circ}$ C, relative humidity 90-100% After being left at room temperature for 2 hours, the test is carried out.	Frequency Change: ± 20 ppm Max. Resistance Change: 10kohm Max.

RELIABILITY

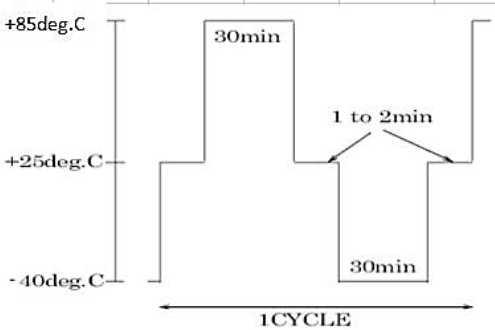
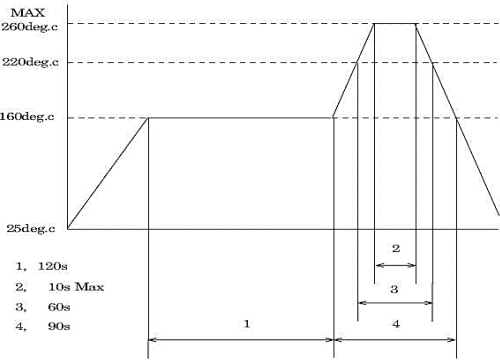
TEST ITEMS	TEST METHOD AND CONDITIONS	REQUIREMENTS
Temperature Cycle	<p>After supplying the following temperature cycle (100 time)</p> 	<p>Frequency Change: $\pm 10\text{ppm}$ Max. Resistance Change: 10kohm Max.</p>
Reflow Soldering		<p>After 24h past from frequency test, Frequency Change: $\pm 20\text{ppm}$ Max. Resistance Change: 20kohm Max.</p> <p>Notice:</p> <ol style="list-style-type: none"> Using the infrared lamp at soldering process may cause uneven temperature rise on plastic surface of the parts, so that please keep the package temperature within left conditions. Do not dip the plastic part into solder

HANDING AND NOTICE FOR STANDARD TUNING FORK CRYSTAL (CYLINDRICAL TYPE)

Shock resistance

It may deteriorate the characteristics or cause of no oscillation if excess physical shock given. Please be careful not to drop. Please use under condition to minimize the shocks as much as possible. Please review the conditions if it is used by auto mounting or after the conditions are changed.

Heat and humidity resistance in storage

Storing the crystal products under higher or lower temperature or high humidity for a long period may deteriorate the characteristics of crystal units. Please store and use the crystal products at the normal temperature and humidity.

Solder heat resistance

Please review the condition or consult us about flow solder process. Our soldering condition is under 260°C within 10sec.

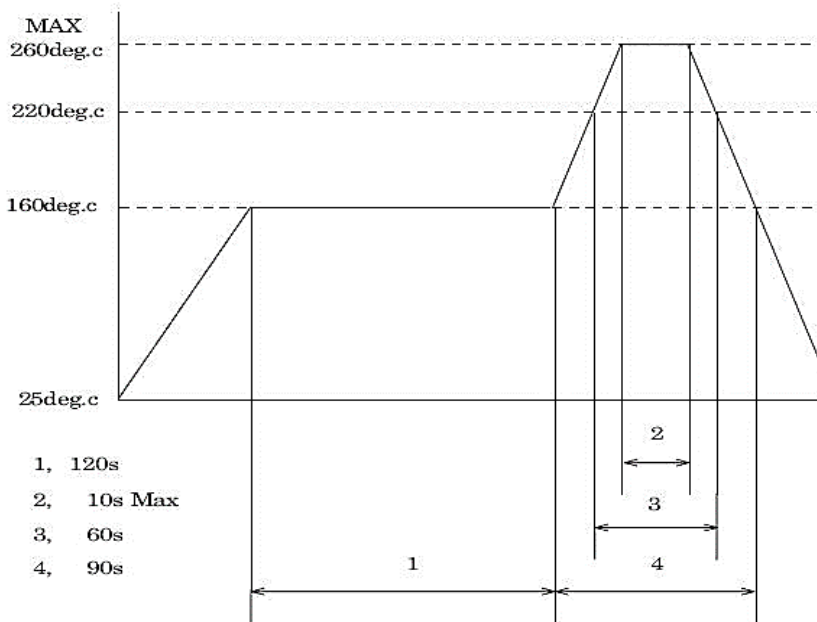

Mounting method to PCB

When the crystal products need to be lay down please fix to PCB securely. Recommended size of solder plate as shown below

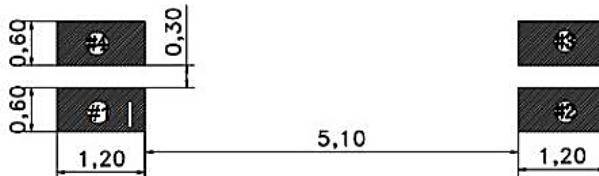

Ultrasonic cleaning and ultrasonic soldering

Soldered by ultrasonic cannot be guaranteed, because crystal may be sympathetic vibrated and may damage.

Please study at your side about ultrasonic cleaning.

Drive level

Applying excessive drive level to the crystal units may cause deterioration of characteristics or damage. Less than $1.0\mu\text{W}$ is recommended to this products. More than $2.0\mu\text{W}$ cannot be guaranteed.

Solder paste should be more than $150\mu\text{m}$ thickness.

Storage environment

To storage the reel at $+15^{\circ}\text{C}$ to $+35^{\circ}\text{C}$, 25%RH to 65%RH of Humidity.

To open the packing just before using.

Not to expose the sun.

Not to storage with some erosive chemicals.

Nothing is allowed to put on the reel or carton to prevent mechanical damage.

REEL AND TAPE DIMENSION (Unit: mm)

All Devices are packed in accordance with EIA standard RS-481-2 and specifications, 3000pcs/Reel

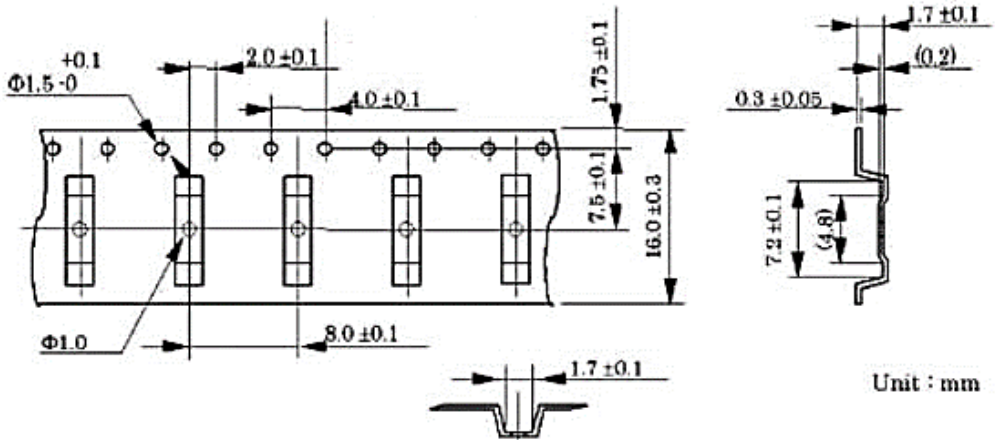

Unit : mm

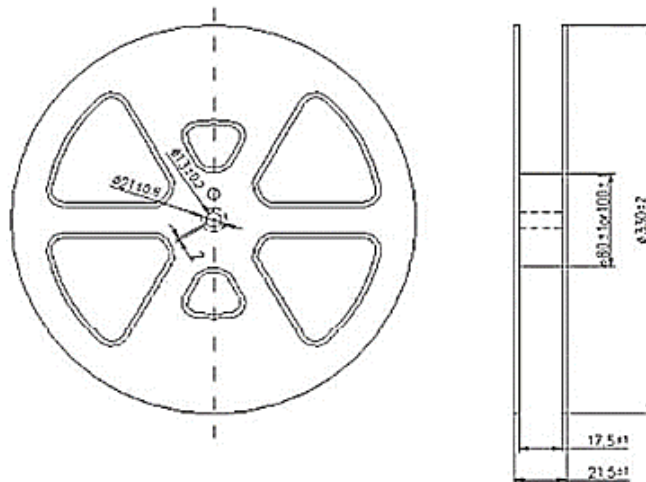
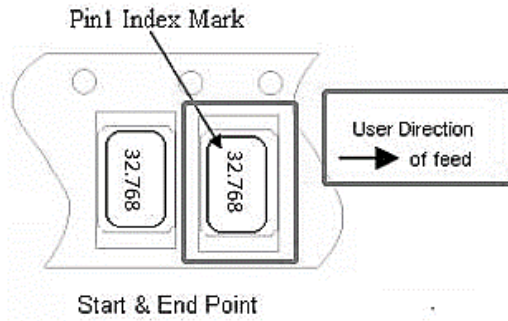

IMPORTANT NOTES AND DISCLAIMER

1. **ROHS COMPLIANCE:** The levels of RoHS restricted materials in this product are below the maximum concentration values (also referred to as the threshold limits) permitted for such substances, or are used in an exempted application, in accordance with EU RoHS Directive (EU) 2015/863 EC (RoHS3). RoHS Test Report for this product can be obtained at Download Center.
2. **REACH COMPLIANCE:** REACH substances of high concern (SVHCs) information is available for this product. Since the European Chemical Agency (ECHA) has published notice of their intent to frequently revise the SVHC listing for the foreseeable future, REACH Test Report for this product can be obtained at Download Center.
3. All Product parametric performance is indicated in the Electrical Characteristics for the listed herein test conditions, unless otherwise noted. Product performance may not be indicated by the Electrical Characteristics if operated under different conditions.
4. NextGen Component, Inc (*NextGen*) reserves the right to make changes to this document and its products and specifications at any time without notice. Customers should obtain and confirm the latest product information and specifications before final design, purchase or use.
5. *NextGen* makes no warranty, representation or guarantee regarding the suitability of its products for any particular purpose, not does *NextGen* assume any liability for application assistance or customer product design.
6. *NextGen* does not warrant or accept any liability with products which are purchased or used for any unintended or unauthorized application. No license is granted by implication or otherwise under any intellectual property rights of NextGen.
7. *NextGen* products are not authorized for use as critical components in life support devices or systems without express written approval by *NextGen*.
8. *NextGen* requires that customers first obtain an RMA (Returned Merchandise Authorization) number prior to returning any products. Returns must be made within 30 days of the date of invoice, be in the original packaging, unused and like-new condition. At the time of quoting or purchasing, a product may say that it is Non-Cancelable/ Non-Returnable (NCNR). These products are not returnable and not refundable.