



SPECIFICATION SHEET NO.	R1010- FM450K0000S007	
ORIGINAL MFG/PART NO	TGS Crystals/CFTC 450HW TLH/LTWC450H	
DATE	Oct. 10, 2024	
REVISION	A4	Updated With Most Recent Data
DESCRIPTION AND MAIN PARAMETRICS	<p>KHz SMD Ceramic Filter, Standard Type, 4 Pads, FM Series</p> <p>Case 12065, Dimension L12.0*W6.5*H3.0mm</p> <p>450KHz, Insertion Loss. 4.0dB Max.; 6dB Bandwidth: ±3.0KHz Min.</p> <p>Input/Output Impedance: 1500 ohm, Operating Temp. Range -20°C ~+85°C</p> <p>Reflow Profile Condition 260 °C Max.</p> <p>Package in Tape/Reel, 1000pcs/Reel</p> <p>REACH/RoHS/RoHS III Compliant, RoHS Annex III lead Exemption (Exempt per RoHS EU 2015/863)</p>	
CUSTOMER		
CUSTOMER PART NUMBER		
CROSS REF. PART NUMBER		
MEMO		

VENDOR APPROVE			
Issued/Checked/Approved			
Date: Oct. 10, 2024			

CUSTOMER APPROVE
Date:

MAIN FEATURE

- KHz SMD Ceramic Filter, Standard Type, 4 pads, Case 12065
- White Case, Dimension L12.0*W6.5*H3.0mm
- Low Cost And Short Shipment
- Reflow Profile Condition 260 °C Max.
- Cross Main Competitors Parts CFWKG series
- REACH/RoHS/RoHS III compliant, RoHS Annex III lead Exemption
(Exempt per RoHS EU 2015/863)



Image shown is a representation only. Exact specifications should be obtained from the product dimension.



APPLICATION

- Communication Electronics

HOW TO ORDER

- Please follow up part code guide and indicate part code when you order or RFQ.

PART CODE GUIDE

RFQ
[Request For Quotation](#)

CODE	NAME	KEY SPECIFICATION OPTION
FM	Product Series	KHz SMD Ceramic Filter, 4 pads, Case 12065 Dimension L12.0*W6.5*H3.0mm
450K	Frequency Range	450: 450KHz; 455K: 455KHz
0000	Internal Control	Letter or Digits (A~Z, a~z or 1~9)
S	SMD Type Package	Tape/Reel
007	Special Parametric	Letter or Digits (A~Z, a~z or 1~9)
- XX	Suffix	Blank: N/A XX: Internal Control Code, Letter A~Z, a~z or digits (0~9) for Special/Custom Parameters

DIMENSION (Unit: mm)

Case 12065, 4 Pads

L12.0*W6.5*H3.0mm

Top View

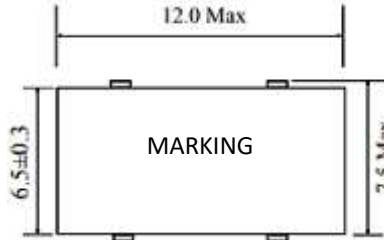

Marking

Line 1: CFTC or LTWC

Line 2: Frequency Range

+ Internal Control Code

Side View

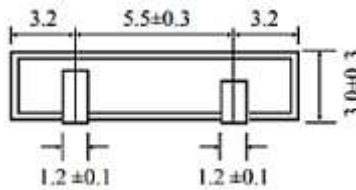

Side View

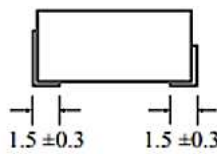

Bottom View

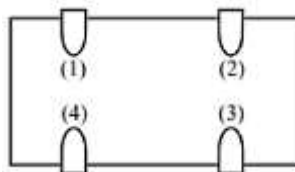

Connection

(1): Pin 1: Input/Output

(2): Pin 2: Output/Input

(3): Pin 3: Ground

(4): Pin 4: Ground

MEASUREMENT

- Measurement shall be carried out at the standard temperature of $25\pm 2^{\circ}\text{C}$. If no specific requirements, Test can be carried out under $5-35^{\circ}\text{C}$.
- Measuring Circuit

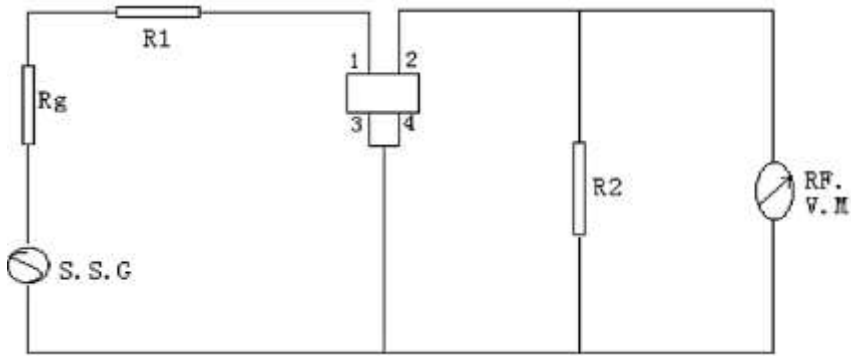

$R_g + R_1 = R_2 = \text{Output/input Impedance}$

GENERAL ELECTRICAL PARAMETERS

PARAMETER	UNITS	VALUE			CONDITION
		MIN.	TYPICAL	MAX.	
Operating Temperature	°C	-20		+85	
Storage Temperature	°C	-40		+85	
Temperature Stability	%			±0.5	@ -20°C ~+85°C
Insulation Resistance	MΩ	100			@DC 25V 1 minute
Stop Band Attenuation	dB	45			Within $f_0 \pm 100\text{KHz}$

RIPPLE PARAMETERS – FOR DIFFERENT PART CODE

PART CODE	UNITS	RIPPLE PARAMETERS			CONDITION
		MIN.	TYPICAL	MAX.	
FM450K0000S001	dB	-	-	2.0	Within $f_0 \pm 11.0\text{KHz}$
FM450K0000S002	dB	-	-	2.0	Within $f_0 \pm 10.0\text{KHz}$
FM450K0000S003	dB	-	-	2.0	Within $f_0 \pm 7.0\text{KHz}$
FM450K0000S004	dB	-	-	2.0	Within $f_0 \pm 5.0\text{KHz}$
FM450K0000S005	dB	-	-	2.0	Within $f_0 \pm 4.0\text{KHz}$
FM450K0000S006	dB	-	-	2.0	Within $f_0 \pm 3.0\text{KHz}$
FM450K0000S007	dB	-	-	2.0	Within $f_0 \pm 2.0\text{KHz}$
FM450K0000S009	dB	-	-	2.0	Within $f_0 \pm 1.0\text{KHz}$
FM455K0000S001	dB	-	-	2.0	Within $f_0 \pm 12.0\text{KHz}$
FM455K0000S002	dB	-	-	2.0	Within $f_0 \pm 10.0\text{KHz}$
FM455K0000S003	dB	-	-	2.0	Within $f_0 \pm 7.0\text{KHz}$
FM455K0000S004	dB	-	-	2.0	Within $f_0 \pm 5.0\text{KHz}$
FM455K0000S005	dB	-	-	2.0	Within $f_0 \pm 4.0\text{KHz}$
FM455K0000S006	dB	-	-	2.0	Within $f_0 \pm 3.0\text{KHz}$
FM455K0000S007	dB	-	-	2.0	Within $f_0 \pm 2.0\text{KHz}$
FM455K0000S009	dB	-	-	2.0	Within $f_0 \pm 1.0\text{KHz}$

ELECTRICAL PARAMETERS – FOR DIFFERENT PART CODE- Ta = 25°C

Part Code	Center Freq.(f0) (Center of 6dB Bandwidth)	3dB Bandwidth	6dB Bandwidth	50dB Bandwidth	Insertion Loss @ Min. Loss Point	Input/ Output Impedance
	KHz	KHz	KHz	KHz	dB	Ω
FM450K0000S001	450±2.0	±11.0 Min.	±15.0 Min.	±30.0 Min.	5.0 Max.	1500
FM450K0000S002	450±1.0	±8.5 Min.	±12.0 Min.	±24.0 Min.	5.0 Max.	1500
FM450K0000S003	450±1.0	±7.0 Min.	±10.5 Min.	±20.0 Min.	5.0 Max.	1500
FM450K0000S004	450±1.0	±5.0 Min.	±7.5 Min.	±15.0 Min.	4.0 Max.	1500
FM450K0000S005	450±1.0	±4.5 Min.	±6.0 Min.	±12.5 Min.	5.0 Max.	1500
FM450K0000S006	450±1.0	±3.0 Min.	±4.5 Min.	±10.0 Min.	4.0 Max.	1500
FM450K0000S007	450±1.0	±2.0 Min.	±3.0 Min.	±9.0 Min.	4.0 Max.	1500
FM450K0000S009	450±1.0	±1.0 Min.	±1.5 Min.	±5.0 Min.	7.0 Max.	1500
FM455K0000S001	455±2.0	±11.0 Min.	±15.0 Min.	±30.0 Min.	5.0 Max.	1500
FM455K0000S002	455±1.0	±8.5 Min.	±12.0 Min.	±24.0 Min.	5.0 Max.	1500
FM455K0000S003	455±1.0	±7.0 Min.	±10.0 Min.	±20.0 Min.	5.0 Max.	1500
FM455K0000S004	455±1.0	±5.0 Min.	±7.5 Min.	±15.0 Min.	4.0 Max.	1500
FM455K0000S005	455±1.0	±4.5 Min.	±6.0 Min.	±12.5 Min.	5.0 Max.	1500
FM455K0000S006	455±1.0	±3.0 Min.	±4.5 Min.	±10.0 Min.	5.0 Max.	1500
FM455K0000S007	455±1.0	±2.0 Min.	±3.0 Min.	±9.0 Min.	5.0 Max.	1500
FM455K0000S009	455±1.0	±1.0 Min.	±1.5 Min.	±5.0 Min.	7.0 Max.	1500

PHYSICAL CHARACTERISTICS

TEST ITEMS	MEASUREMENT CONDITION	REQUIREMENT
Random Drop	Filter shall be measured after 3 times random drops from the height of 30cm on concrete floor	No visible damage and it meet Table at Page 4~6
Vibration	Filter shall be measured after being applied vibration of amplitude of 1.5mm with 10-55Hz band of vibration frequency to each of 3 perpendicular directions for 2 hours	No visible damage and it meet Table at Page 4~6
Solderability	Lead terminals are immersed in aide solder for 5 sec and then immersed in soldering bath of 230±5°C, for 3±0.5 sec.	At least 95% lead terminals shall be covered with solder.
Substrate Bending Test	Apply pressure in the direction of arrow at a rate of about 0.5mm per second until it reaches a bend of 3mm and hold for 30s.	No visible damage and it meet Table at Page 4~6
Adhesion	A static load of 20N to the direction of the arrow shall be applied on the core of the component and hold for 10 seconds. Filter shall be soldered correctly and tightly to PCB.	No visible damage and it meet Table at Page 4~6
Reflow Soldering	Put on the solder paste on the printed wiring board the samples shall be mounted and soldered under the condition, then it shall be subjected to the room atmosphere for 24 hours prior to the measurement.	No visible damage and it meet Table at Page 4~6

ENVIRONMENTAL CHARACTERISTICS

TEST ITEMS	MEASUREMENT CONDITION	REQUIREMENT
Humidity	After being placed in a chamber with 90-95% R.H. at 40±2°C for 100 hours and then being placed in room temperature for 1 hour, filter shall be measured.	It shall meet Table at Page 4~6
Resistance to Solder Heat	After being placed in a chamber with 80±2°C, for 100 hours and then being placed in room temperature for 1 hour, filter shall be measured.	It shall meet Table at Page 4~6
High Temperature	After being placed in a chamber with 80±2°C, for 100 hours and then being placed in room temperature for 1 hour, filter shall be measured.	It shall meet Table at Page 4~6
Low Temperature	After being placed in a chamber with -20±2°C, for 100 hours and then being placed in room temperature for 1 hour, filter shall be measured.	It shall meet Table at Page 4~6
Heat Shock	After being kept at room temperature, filter shall be placed at temperature of -55 °C, for 30 minutes, then be placed at temperature. 85°C, for 30 minutes. After that returned to -55°C again. Repeated above cycle for 5 times. After being kept in room temp. for 1 hour, filter shall be measured	It shall meet Table at Page 4~6

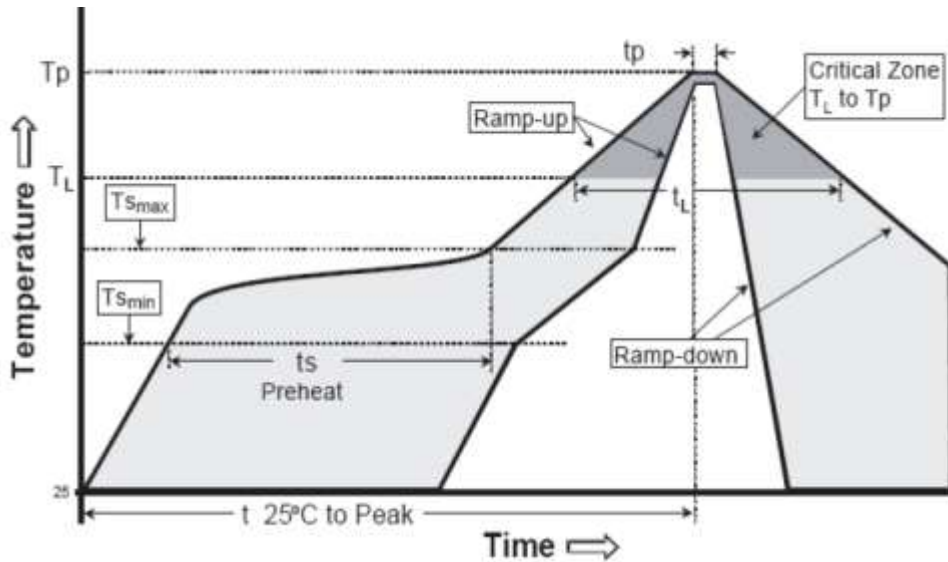
SUGGESTED REFLOW PROFILE (For Reference Only)

PROFILE FEATURE		PB-FREE ASSEMBLY
Average Ramp-up Rate (Ts Max to Tp)		3°C/second Max
Preheat	Temperature Min (Ts Min.)	125°C
	Temperature Max (Ts Max.)	200°C
	Time (ts Min. to ts Max.)	60 ~ 180 seconds
Time maintained above	Temperature (T_L)	217°C
	Time (t_L)	60 ~ 150 seconds
Peak/Classification Temperature (T_p)		260 °C
Time within 5°C of actual Peak Temperature (t_p)		20 ~ 40 seconds
Ramp-down rate		6 °C /Second Max.
Time 25 °C to Peak Temperature		8 minutes Max.
Suggest reflow times		3 Times Max.

TAPE AND REEL (Unit: mm, 1000pcs/Reel)

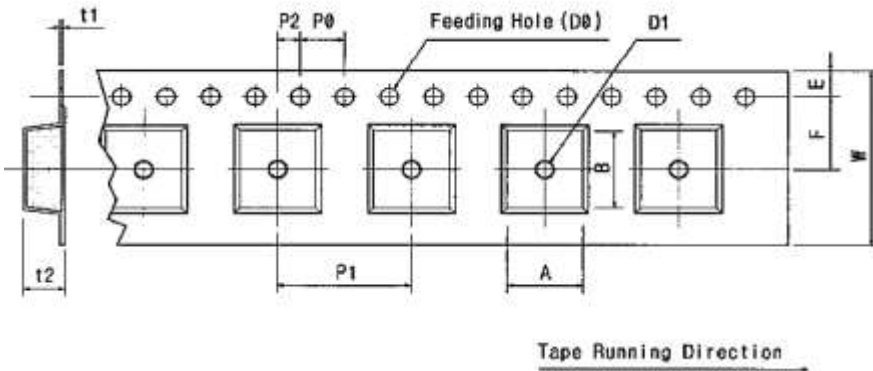

Code	Dimension
W	24.0+/-0.30
F	11.5+/-0.05
E	1.75+/-0.10
P 0	4.00+/-0.10
P 1	12.0+/-0.10
P 2	2.00+/-0.05
D 0	Ø1.5+/-0.10
D 1	Ø1.0+/-0.25
t 1	0.35+/-0.10
t 2	3.20+/-0.10
A	7.70+/-0.10
B	12.0+/-0.10

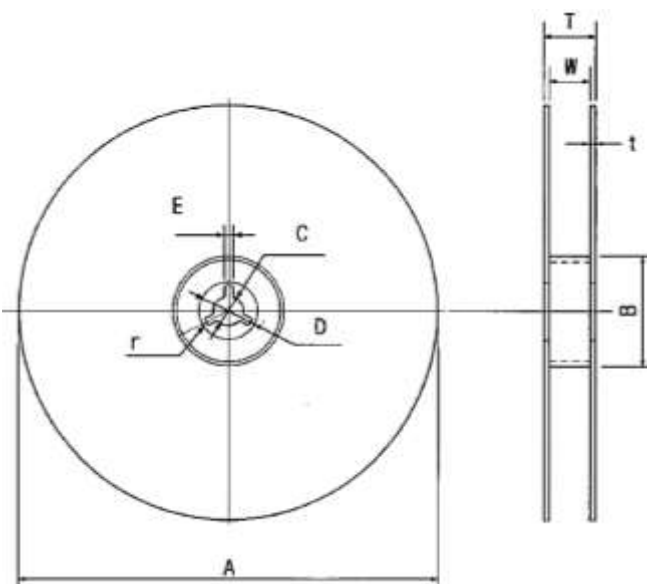

Code	Dimension
A	Ø180+/-1.0
B	Ø60+/-0.5
C	Ø13.0+/-0.5
E	2.00+/-0.5
W	17.0+/-1.0
T	19.4+/-0.3

IMPORTANT NOTES AND DISCLAIMER

1. **ROHS COMPLIANCE:** The levels of RoHS restricted materials in this product are below the maximum concentration values (also referred to as the threshold limits) permitted for such substances, or are used in an exempted application, in accordance with EU RoHS Directive (EU) 2015/863 EC (RoHS3). RoHS Test Report for this product can be obtained at Download Center.
2. **REACH COMPLIANCE:** REACH substances of high concern (SVHCs) information is available for this product. Since the European Chemical Agency (ECHA) has published notice of their intent to frequently revise the SVHC listing for the foreseeable future, REACH Test Report for this product can be obtained at Download Center.
3. All Product parametric performance is indicated in the Electrical Characteristics for the listed herein test conditions, unless otherwise noted. Product performance may not be indicated by the Electrical Characteristics if operated under different conditions.
4. NextGen Component, Inc (*NextGen*) reserves the right to make changes to this document and its products and specifications at any time without notice. Customers should obtain and confirm the latest product information and specifications before final design, purchase or use.
5. *NextGen* makes no warranty, representation or guarantee regarding the suitability of its products for any particular purpose, not does *NextGen* assume any liability for application assistance or customer product design.
6. *NextGen* does not warrant or accept any liability with products which are purchased or used for any unintended or unauthorized application. No license is granted by implication or otherwise under any intellectual property rights of NextGen.
7. *NextGen* products are not authorized for use as critical components in life support devices or systems without express written approval by *NextGen*.
8. *NextGen* requires that customers first obtain an RMA (Returned Merchandise Authorization) number prior to returning any products. Returns must be made within 30 days of the date of invoice, be in the original packaging, unused and like-new condition. At the time of quoting or purchasing, a product may say that it is Non-Cancelable/ Non-Returnable (NCNR). These products are not returnable and not refundable.