



SPECIFICATION SHEET NO.	R1019- CP4M000000S015	
ORIGINAL MFG/PART NO	TGS Crystals/C RTP 4.0MG-15TLH/ZTTC P4.0MG-15	
DATE	Oct. 19, 2024	
REVISION	A2	Updated With Most Recent Data
DESCRIPTION AND MAIN PARAMETRICS	<p>MHz SMD Ceramic Resonator, 3 Pads, CP Series</p> <p>Case 6030, Dimension L6.0*W3.0*H1.5mm</p> <p>4.0MHz, Frequency Accuracy $\pm 0.5\%$; Built-in Capacitance 15pF</p> <p>Operating Temp. Range -25°C ~+85°C</p> <p>Reflow Profile Condition 260 °C Max.</p> <p>Package in Tape/Reel, 4000pcs/Reel</p> <p>REACH/RoHS/RoHS III Compliant, RoHS Annex III lead Exemption (Exempt per RoHS EU 2015/863)</p>	
CUSTOMER		
CUSTOMER PART NUMBER		
CROSS REF. PART NUMBER		
MEMO		

VENDOR APPROVE		
Issued/Checked/Approved		
		
Date: Oct. 19, 2024		

CUSTOMER APPROVE
Date:

MAIN FEATURE

- MHz SMD Ceramic Resonator, 3 pads, Case 6030,
- Case Dimension L6.0*W3.0*H1.5mm
- Low Cost And Short Shipment
- Cross More Competitors Part
- Built-in Capacitance
- Reflow Profile Condition 260 °C Max.
- REACH/RoHS/RoHS III compliant, RoHS Annex III lead Exemption
(Exempt per RoHS EU 2015/863)



Image shown is a representation only. Exact specifications should be obtained from the product dimension.



APPLICATION

- Communication Electronics
- Bluetooth, wireless communication set

HOW TO ORDER

- Please follow up part code guide and indicate part code when you order or RFQ.

RFQ

[Request For Quotation](#)

PART CODE GUIDE

CODE	NAME	KEY SPECIFICATION OPTION
CP	Product Series	MHz SMD Ceramic Resonator, 3 pads, Case 6030 Dimension L6.0*W3.0*H1.5mm
4M0	Frequency Range	4M0: 4.00MHz
00000	Internal Control	Letter or Digits (A~Z, a~z or 1~9)
S	SMD Type Package	Tape/Reel
015	Special Parametric	Letter or Digits (A~Z, a~z or 1~9)
-XX	Suffix	Blank: N/A XX: Internal Control Code, Letter A~Z, a~z or digits (0~9) for Special/Custom Parameters

DIMENSION (Unit: mm)

Case 6030, 3 Pads

L6.0*W3.0*H1.5mm

Top View

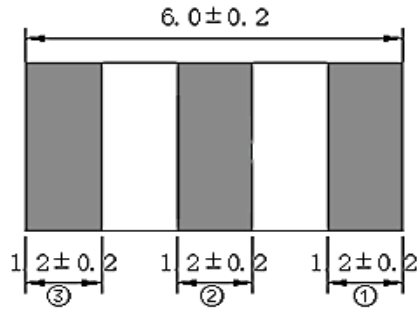

Marking

Frequency Range

+ QC Code

Connection: ① Input ② Ground ③ Output

Side View

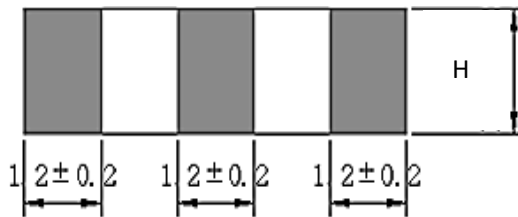

H	Freq. Range (MHz)
1.8±0.2	1.84~3.50
1.5±0.2	3.51~12.0
1.6±0.2	20.0

Bottom View

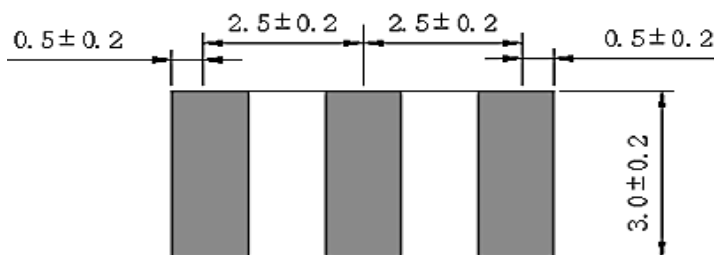

MEASUREMENT

- Parts shall be tested under the condition (Temp.: $20 \pm 15^{\circ}\text{C}$, Humidity $65 \pm 20\%$ R.H.) unless the standard condition (Temp.: $25 \pm 3^{\circ}\text{C}$, Humidity : $65 \pm 10\%$ R.H.) is regulated to measure.
- Measuring Circuit

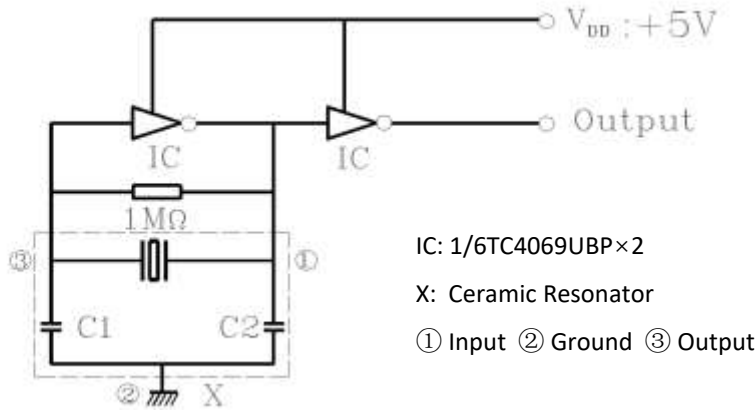

GENERAL ELECTRICAL CHARACTERISTICS AND RATING- FOR DIFFERENT PART CODE- Ta = 25°C

PARAMETER	SYMBOLS	VALUE	UNITS	CONDITION
Withstanding Voltage	-	100	V	@DC, 5s Max.
Insulation Resistance	R _i	500 Min.	mΩ	@10V, 1min.
Operating Temperature Range	T _J	-25 to +85	°C	
Storage Temperature Range	T _{STG}	-55 to +85	°C	
Rating Voltage	U _R	6	V DC	
		15	V _{p-p} AC	
Temperature Coefficient of Oscillation Frequency		±0.3 Max.	%	-25°C ~ +85°C
Oscillation Frequency Aging Rate *		±0.1 Max.		From initial value

Note: * : Components shall be left in a chamber of $+85 \pm 2^{\circ}\text{C}$ for 1000 hours, then measured after leaving in natural condition for 1 hours. View

ELECTRICAL CHARACTERISTICS - FOR DIFFERENT PART CODE

PART CODE	CENTER FREQUENCY (F0)	FREQUENCY ACCURACY	MAX. RESONANT IMPEDANCE R0	BUILT-IN CAP. C1, C2	Case Thickness H	IC MODEL NO.
	MHz	%	Ω	pF	mm	
CP2M000000S015	2.00	±0.5	100	15 (1±20%)	1.8±0.2	1/6TC4069UBPx2
CP2M000000S030	2.00	±0.5	100	30 (1±20%)	1.8±0.2	1/6TC4069UBPx2
CP2M000000S047	2.00	±0.5	100	47 (1±20%)	1.8±0.2	1/6TC4069UBPx2
CP2M450000S030	2.45	±0.5	100	30 (1±20%)	1.8±0.2	1/6TC4069UBPx2
CP2M500000S030	2.50	±0.5	100	30 (1±20%)	1.8±0.2	1/6TC4069UBPx2
CP2M500000S047	2.50	±0.5	100	47 (1±20%)	1.8±0.2	1/6TC4069UBPx2
CP3M000000S030	3.00	±0.5	50	30 (1±20%)	1.8±0.2	1/6TC4069UBPx2
CP3M580000S015	3.58	±0.5	30	15 (1±20%)	1.5±0.2	1/6TC4069UBPx2
CP3M580000S030	3.58	±0.5	30	30 (1±20%)	1.5±0.2	1/6TC4069UBPx2
CP3M580000S033	3.58	±0.5	30	33 (1±20%)	1.5±0.2	1/6TC4069UBPx2
CP3M580000S047	3.58	±0.5	30	47 (1±20%)	1.5±0.2	1/6TC4069UBPx2
CP3M680000S030	3.68	±0.5	30	30 (1±20%)	1.5±0.2	1/6TC4069UBPx2
CP3M680000S033	3.68	±0.5	30	33 (1±20%)	1.5±0.2	1/6TC4069UBPx2
CP4M000000S010	4.00	±0.5	30	10 (1±20%)	1.5±0.2	1/6TC4069UBPx2
CP4M000000S015	4.00	±0.5	30	15 (1±20%)	1.5±0.2	1/6TC4069UBPx2
CP4M000000S030	4.00	±0.5	30	30 (1±20%)	1.5±0.2	1/6TC4069UBPx2
CP4M000000S033	4.00	±0.5	30	33 (1±20%)	1.5±0.2	1/6TC4069UBPx2
CP4M190000S030	4.19	±0.5	30	30 (1±20%)	1.5±0.2	1/6TC4069UBPx2
CP4M190000S033	4.19	±0.5	30	33 (1±20%)	1.5±0.2	1/6TC4069UBPx2

ELECTRICAL CHARACTERISTICS - FOR DIFFERENT PART CODE

PART CODE	CENTER FREQUENCY (F0)	FREQUENCY ACCURACY	MAX. RESONANT IMPEDANCE R0	BUILT-IN CAP. C1, C2	Case Thickness H	IC MODEL NO.
	MHz	%	Ω	pF	mm	
CP4M910000S001	4.91	±0.5	30	30 (1±20%)	1.5±0.2	1/6TC4069UBPx2
CP4M910000S015	4.91	±0.5	30	15 (1±20%)	1.5±0.2	1/6TC4069UBPx2
CP4M910000S030	4.91	±0.5	35	30 (1±20%)	1.5±0.2	1/6TC4069UBPx2
CP5M000000S030	5.00	±0.5	30	30 (1±20%)	1.5±0.2	1/6TC4069UBPx2
CP6M000000S030	6.00	±0.5	30	30 (1±20%)	1.5±0.2	1/6TC4069UBPx2
CP7M370000S030	7.37	±0.5	30	30 (1±20%)	1.5±0.2	1/6TC4069UBPx2
CP8M000000S015	8.00	±0.5	30	15 (1±20%)	1.5±0.2	1/6TC4069UBPx2
CP8M000000S030	8.00	±0.5	30	30 (1±20%)	1.5±0.2	1/6TC4069UBPx2
CP8M000000S033	8.00	±0.5	30	33 (1±20%)	1.5±0.2	1/6TC4069UBPx2
CP8M000000S047	8.00	±0.5	30	47 (1±20%)	1.5±0.2	1/6TC4069UBPx2
CP10M000000S030	10.0	±0.5	30	30 (1±20%)	1.5±0.2	1/6TC4069UBPx2
CP12M000000S030	12.0	±0.5	30	30 (1±20%)	1.5±0.2	1/6TC4069UBPx2
CP20M000000S010	20.0	±0.5	60	10 (1±20%)	1.6±0.2	1/6TC4069UBPx2

PHYSICAL AND ENVIRONMENTAL CHARACTERISTICS

TEST ITEMS	TEST METHOD AND CONDITIONS	REQUIREMENT
Humidity	Keep the resonator at $60^{\circ}\text{C} \pm 2^{\circ}\text{C}$ and 90%-95% RH for 96h. Then Release the resonator into the room Condition for 1h prior to the Measurement.	It shall fulfill the specifications in Table 1
High Temperature	Subject the resonator to $85^{\circ}\text{C} \pm 2^{\circ}\text{C}$ for 96h, then release the resonator into the room conditions for 1h prior to the measurement.	It shall fulfill the specifications in Table 1
Low Temperature	Subject the resonator to $-40^{\circ}\text{C} \pm 2^{\circ}\text{C}$ for 96h, then release the resonator into the room conditions for 1h prior to the measurement.	It shall fulfill the specifications in Table 1
Temperature Cycling	After temperature cycling of blow table was performed 5 times, resonator shall be measured after being placed in natural conditions for 1h. Temp.: $-25 \pm 3^{\circ}\text{C}$, Time: 30 ± 3 min ; Temp.: $85 \pm 3^{\circ}\text{C}$, Time: 30 ± 3 min.	It shall fulfill the specifications in Table 1
Vibration	Subject the resonator to vibration for 2h each in x、 y and z axis With the amplitude of 1.5mm, the frequency shall be varied uniformly between the limits of 10 Hz—55Hz.	It shall fulfill the specifications in Table 1
Mechanical Shock	Drop the resonator randomly onto a wooden floor from the height of 100cm 3 times.	It shall fulfill the specifications in Table 1
Soldering Test	Components shall be measured after applying twice of the re-flow soldering with following temperature profile and leaving in natural condition for 1 hour.	It shall fulfill the specifications in Table 1
Solderability	Dipped in $245^{\circ}\text{C} \pm 5^{\circ}\text{C}$ solder bath for $3\text{s} \pm 0.5\text{s}$ with rosin flux (25wt% ethanol solution.). see Suggested Reflow Profile	The terminals shall be at least 95% covered by solder.
Board Bending	Mount on a glass-epoxy board(width =40mm, thickness=1.6mm), then bend it to 1mm displacement (velocity= 1mm/s) and keep it for 5s. See the following figure at next page.	Mechanical damage such as break shall not occur

Table 1

TEST ITEMS	CHARACTERISTICS AFTER TEST	
	VALUE	UNITS
Oscillation Frequency Change $\Delta F_{osc}/F_{osc}$	± 0.3 Max	%
Resonant Impedance ΔR_o	30 Max.	Ω

Note: The limits in the above table are referenced to the initial measurements.

Soldering Test

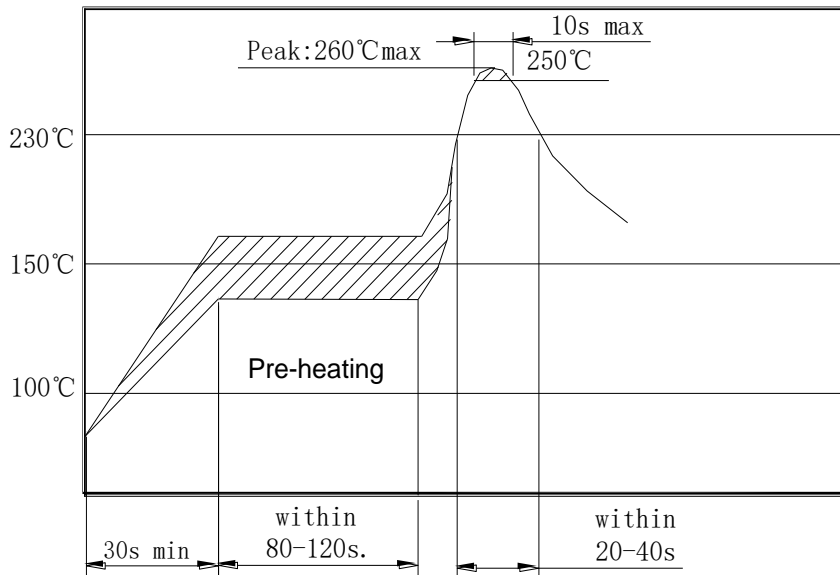

Board Bending

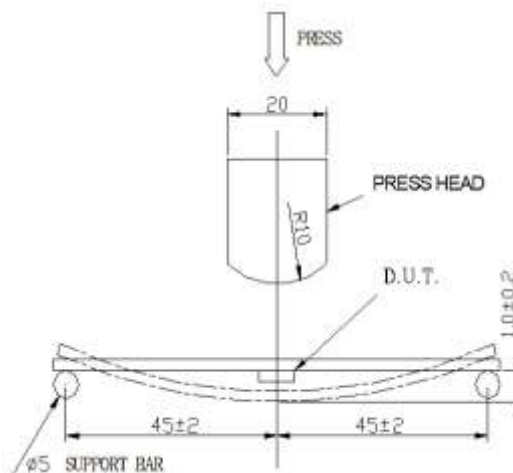

SUGGESTED REFLOW PROFILE (For Reference Only)

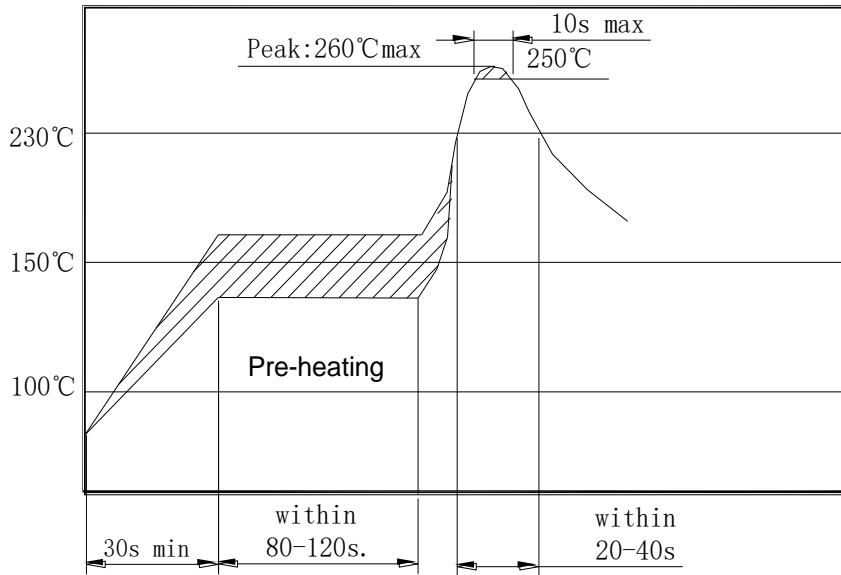

RECOMMENDED LAND PATTERN (Unit: mm)

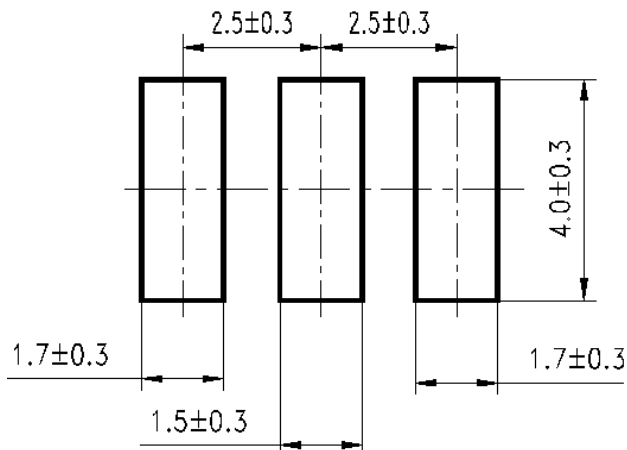

TPAE/REEL DIMENSIONS (Unit: mm)

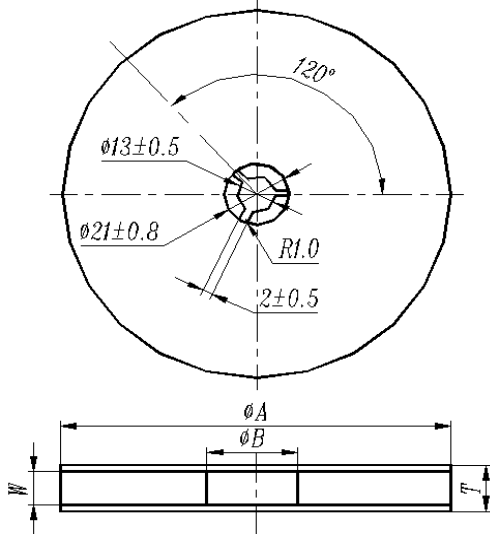

CODE	DIMENSION
φA	330±3.0
φB	80 Min.
W	16.4 Min.
T	22.4 Max.
Qty. Per Reel	4000pcs
Carrier Tape Size	16

PACKING METHOD SKETCH MAP

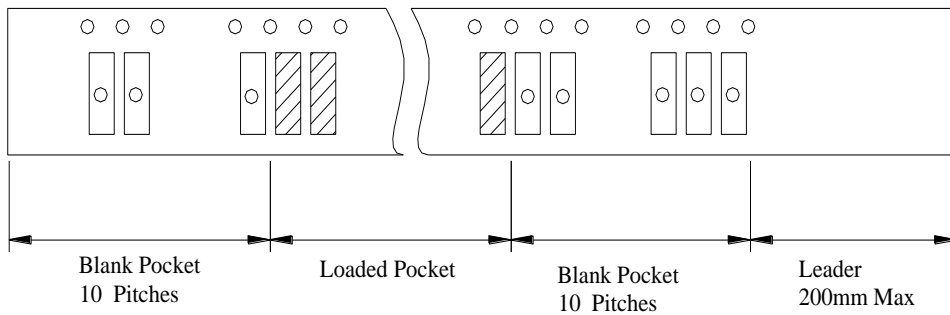

TEST CONDITION OF PEELING STRENGTH

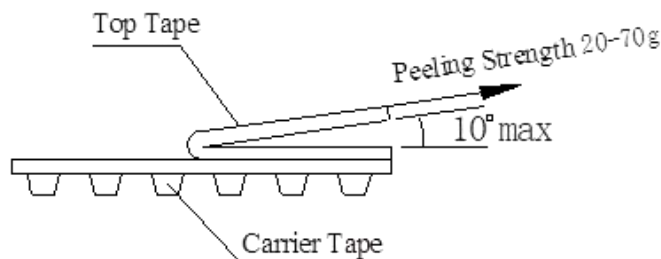

CAUTION

- Don't apply excess mechanical stress to the component and terminals at soldering. Do not use this product with bend.
- Do not clean or wash the component for it is not hermetically sealed.
- Do not use strong acidity flux, more than 0.2wt% chlorine content, in flow soldering.
- Don't be close to fire.
- This specification mentions the quality of the component as a single unit. Please insure the component is thoroughly evaluated in your application circuit
- Expire date (Shelf life) of the products is 12 months after delivery under the conditions of a sealed and an unopened package. Please use the products within 12 months after delivery. If you store the products for a long time (more than 12 months), use carefully because the products may be degraded in the solder-ability or rusty. Please confirm solder-ability and characteristics for the products regularly.
- Exposure components under soldering condition that is exceeding our recommendation will increase the failure dangerous.
- Please contact us before using the product as automobile electronic component.
- Please return one of these specifications after your signature of acceptance.
- When something gets doubtful with this specifications, we shall jointly work to get an agreement.
- For questions on technology, prices and delivery, please contact our sales offices or e-mail:
sales@NextGenComponent.com .

IMPORTANT NOTES AND DISCLAIMER

1. **ROHS COMPLIANCE:** The levels of RoHS restricted materials in this product are below the maximum concentration values (also referred to as the threshold limits) permitted for such substances, or are used in an exempted application, in accordance with EU RoHS Directive (EU) 2015/863 EC (RoHS3). RoHS Test Report for this product can be obtained at Download Center.
2. **REACH COMPLIANCE:** REACH substances of high concern (SVHCs) information is available for this product. Since the European Chemical Agency (ECHA) has published notice of their intent to frequently revise the SVHC listing for the foreseeable future, REACH Test Report for this product can be obtained at Download Center.
3. All Product parametric performance is indicated in the Electrical Characteristics for the listed herein test conditions, unless otherwise noted. Product performance may not be indicated by the Electrical Characteristics if operated under different conditions.
4. NextGen Component, Inc (*NextGen*) reserves the right to make changes to this document and its products and specifications at any time without notice. Customers should obtain and confirm the latest product information and specifications before final design, purchase or use.
5. *NextGen* makes no warranty, representation or guarantee regarding the suitability of its products for any particular purpose, not does *NextGen* assume any liability for application assistance or customer product design.
6. *NextGen* does not warrant or accept any liability with products which are purchased or used for any unintended or unauthorized application. No license is granted by implication or otherwise under any intellectual property rights of NextGen.
7. *NextGen* products are not authorized for use as critical components in life support devices or systems without express written approval by *NextGen*.
8. *NextGen* requires that customers first obtain an RMA (Returned Merchandise Authorization) number prior to returning any products. Returns must be made within 30 days of the date of invoice, be in the original packaging, unused and like-new condition. At the time of quoting or purchasing, a product may say that it is Non-Cancelable/ Non-Returnable (NCNR). These products are not returnable and not refundable.