



SPECIFICATION SHEET NO.	R1110-YA100K0000L123	
ORIGINAL MFG/PART NO	TGS/CCA 100K0A30-12.5-20-35TLF/DTLF206/AD2	
NEXTGEN PART CODE	YA100K0000L123	Indicate This Code For RFQ /Order
DATE	Nov. 10, 2024	
REVISION	A10	Updated With Most Recent Data
DESCRIPTION AND MAIN PARAMETRICS	KHz DIP Crystals, Case Dia.2x6, 2 Pins, YA series, Dimension: \varnothing 2.1*L6.2mm Max. 100.0000KHz, Tolerance: \pm 30ppm, Load Capacitance (CL) 12.5pF ESR 35 Kohm Max., Operating Temp. Range -20°C ~+70°C REACH/RoHS/RoHS III Compliant Packed in Bulk, 1000pcs/Bag	
CUSTOMER		
CUSTOMER PART NUMBER		
CROSS REF. PART NUMBER		
MEMO		

VENDOR APPROVE		
Issued/Checked/Approved		
		
Date: Nov.10, 2024		

CUSTOMER APPROVE	
Date:	

MAIN FEATURE

- DIP Package, Case Dia.2x6, Dimension $\varnothing 2.1 * L6.2mm$ Max., 2 Pins
- Available Load Capacitance CL 6pF/7pF/9pF/12.5pF
- Low ESR 35 Kohm Max.
- Offer Quality Alternatives Parts For Major Brand and more
- Moisture Sensitivity Level (MSL) 1 (Unlimited)
- REACH/RoHS/RoHS III Compliant



Image shown is a representation only. Exact specifications should be obtained from the product dimension.

MAIN APPLICATION

- Small Communications Devices And More



ELECTRICAL CHARACTERISTICS

- See Page 4~Page 8 For Different Part Code.
- All Products Parameters are Subject To Our Final Confirmation.



HOW TO ORDER

- Please Follow Up Part Code Guide And Indicate Part Code YA100K0000L123 For RFQ/Order.

RFQ
Request For Quotation

PART CODE GUIDE

CODE	NAME	KEY SPECIFICATION OPTION
YA	Product Index	KHz Crystal, Case Dia.2x6, $\varnothing 2.1 * L6.2mm$ Max., 2 Pins
100K0	Frequency Range	100K0: 100.00KHz
000L	Internal Control	Special letter A~Z , a~z or digits (1-9)
123	Parameters	Special Parameters Code letter A~Z, a~z or digits (1-9)
XX	Suffix	Blank: N/A; XX: Letter A~Z, a~z or digits (0~9) for Custom Parameters

DIMENSION (Unit: mm)

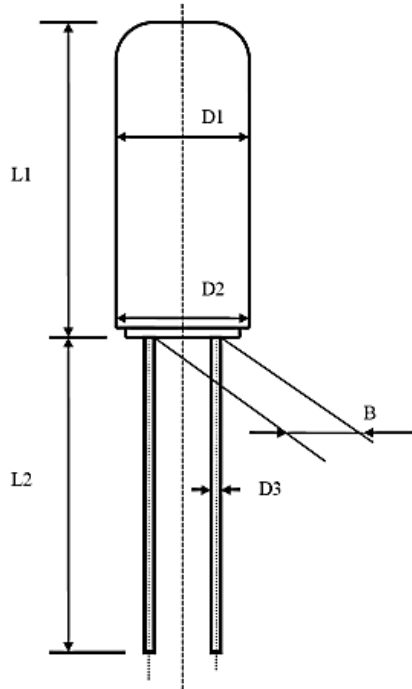

SYMBOL	L1	L2	D1	D2	D3	B
Dimension	6.2 Max	5.0 Min	$\varnothing 1.95 \pm 0.1$	$\varnothing 2.0 \pm 0.1$	$\varnothing 0.25 \pm 0.02$	0.65 ± 0.02

EQUIVALENT CIRCUITS

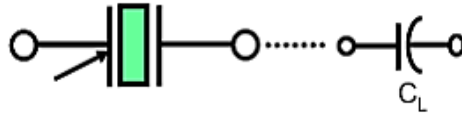

Symbol for crystal unit

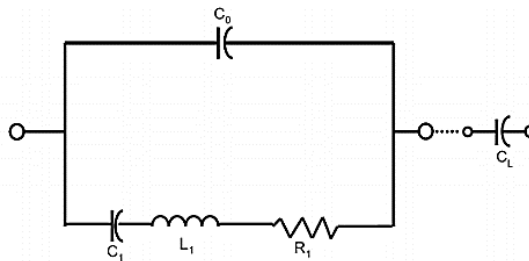

GENERAL ELECTRICAL PARAMETERS

PARAMETERS	SYMBOL	UNITS	VALUE			CONDITION
			MIN.	TYP.	MAX.	
Frequency Temp. Coefficient	$\Delta f/f_0$	ppm/C ²	-0.034 ± 0.006			
Turnover Temperature	T _m	°C	20	25	30	
Storage Temperature Range	T _{ST}	°C	-40		+85	
Shunt Capacitance	C ₀	pF	0.9	1.50	2.0	
Motional Capacitance	C ₁	fF		2.5	4.0	
Insulation Resistance	IR	mΩ	500			DC100V ± 15V
Drive Level	DL	μW		0.1	1.0	
Aging per Year	$\Delta f/f$	ppm			±5	@25°C±3°C
Moist are Sensitivity Level	MSL		1			J-STD-033

ELECTRICAL PARAMETERS – FOR DIFFERENT PART CODE- Ta = 25°C

NEXTGEN PART CODE	ORIGINAL PART NUMBER	FREQUENCY	FREQUENCY	LOAD	OPERATION	ESR
		RANGE	TOLERANCE	CAPACITANCE	TEMP.	MAX.
		KHz	ppm	pF	°C	KΩ
YA32K00000L122	CCA 32K0A20-12.5-20-35TLF	32.000	±20	12.5	-20~+70	35
YA32K00000L142	CCA 32K0A20-12.5-40-35TLF	32.000	±20	12.5	-40~+85	35
YA32K00000L123	CCA 32K0A30-12.5-20-35TLF	32.000	±30	12.5	-20~+70	35
YA32K00000L143	CCA 32K0A30-12.5-40-35TLF	32.000	±30	12.5	-40~+85	35
YA32K76800L625	CCA 32K768A5-6-20-35TLF	32.768	±5	6	-20~+70	35
YA32K76800L645	CCA 32K768A5-6-40-35TLF	32.768	±5	6	-40~+85	35
YA32K76800L621	CCA 32K768A10-6-20-35TLF	32.768	±10	6	-20~+70	35
YA32K76800L641	CCA 32K768A10-6-40-35TLF	32.768	±10	6	-40~+85	35
YA32K76800L622	CCA 32K768A20-6-20-35TLF	32.768	±20	6	-20~+70	35
YA32K76800L642	CCA 32K768A20-6-40-35TLF	32.768	±20	6	-40~+85	35
YA32K76800L623	CCA 32K768A30-6-20-35TLF	32.768	±30	6	-20~+70	35
YA32K76800L643	CCA 32K768A30-6-40-35TLF	32.768	±30	6	-40~+85	35
YA32K76800L725	CCA 32K768A5-7-20-35TLF	32.768	±5	7	-20~+70	35
YA32K76800L745	CCA 32K768A5-7-40-35TLF	32.768	±5	7	-40~+85	35
YA32K76800L721	CCA 32K768A10-7-20-35TLF	32.768	±10	7	-20~+70	35
YA32K76800L741	CCA 32K768A10-7-40-35TLF	32.768	±10	7	-40~+85	35
YA32K76800L722	CCA 32K768A20-7-20-35TLF	32.768	±20	7	-20~+70	35
YA32K76800L742	CCA 32K768A20-7-40-35TLF	32.768	±20	7	-40~+85	35
YA32K76800L723	CCA 32K768A30-7-20-35TLF	32.768	±30	7	-20~+70	35
YA32K76800L743	CCA 32K768A30-7-40-35TLF	32.768	±30	7	-40~+85	35

ELECTRICAL PARAMETERS – FOR DIFFERENT PART CODE- Ta = 25°C

NEXTGEN PART CODE	ORIGINAL PART NUMBER	FREQUENCY	FREQUENCY	LOAD	OPERATION	ESR
		RANGE	TOLERANCE	CAPACITANCE	TEMP.	MAX.
		KHz	ppm	pF	°C	KΩ
YA32K76800L925	CCA 32K768A5-9-20-35TLF	32.768	±5	9	-20~+70	35
YA32K76800L945	CCA 32K768A5-9-40-35TLF	32.768	±5	9	-40~+85	35
YA32K76800L921	CCA 32K768A10-9-20-35TLF	32.768	±10	9	-20~+70	35
YA32K76800L941	CCA 32K768A10-9-40-35TLF	32.768	±10	9	-40~+85	35
YA32K76800L922	CCA 32K768A20-9-20-35TLF	32.768	±20	9	-20~+70	35
YA32K76800L942	CCA 32K768A20-9-40-35TLF	32.768	±20	9	-40~+85	35
YA32K76800L923	CCA 32K768A30-9-20-35TLF	32.768	±30	9	-20~+70	35
YA32K76800L943	CCA 32K768A30-9-40-35TLF	32.768	±30	9	-40~+85	35
YA32K76800L125	CCA 32K768A5-12.5-20-35TLF	32.768	±5	12.5	-20~+70	35
YA32K76800L145	CCA 32K768A5-12.5-40-35TLF	32.768	±5	12.5	-40~+85	35
YA32K76800L121	CCA 32K768A10-12.5-20-35TLF	32.768	±10	12.5	-20~+70	35
YA32K76800L141	CCA 32K768A10-12.5-40-35TLF	32.768	±10	12.5	-40~+85	35
YA32K76800L122	CCA 32K768A20-12.5-20-35TLF	32.768	±20	12.5	-20~+70	35
YA32K76800L142	CCA 32K768A20-12.5-40-35TLF	32.768	±20	12.5	-40~+85	35
YA32K76800L123	CCA 32K768A30-12.5-20-35TLF	32.768	±30	12.5	-20~+70	35
YA32K76800L143	CCA 32K768A30-12.5-40-35TLF	32.768	±30	12.5	-40~+85	35
YA40K00000L122	CCA 40K0A20-12.5-20-35TLF	40.000	±20	12.5	-20~+70	35
YA40K00000L142	CCA 40K0A20-12.5-40-35TLF	40.000	±20	12.5	-40~+85	35
YA40K00000L123	CCA 40K0A30-12.5-20-35TLF	40.000	±30	12.5	-20~+70	35
YA40K00000L143	CCA 40K0A30-12.5-40-35TLF	40.000	±30	12.5	-40~+85	35

ELECTRICAL PARAMETERS – FOR DIFFERENT PART CODE- Ta = 25°C

NEXTGEN PART CODE	ORIGINAL PART NUMBER	FREQUENCY	FREQUENCY	LOAD	OPERATION	ESR
		RANGE	TOLERANCE	CAPACITANCE	TEMP.	MAX.
		KHz	ppm	pF	°C	KΩ
YA60K00000L122	CCA 60K0A20-12.5-20-35TLF	60.000	±20	12.5	-20~+70	35
YA60K00000L142	CCA 60K0A20-12.5-40-35TLF	60.000	±20	12.5	-40~+85	35
YA60K00000L123	CCA 60K0A30-12.5-20-35TLF	60.000	±30	12.5	-20~+70	35
YA60K00000L143	CCA 60K0A30-12.5-40-35TLF	60.000	±30	12.5	-40~+85	35
YA65K53600L122	CCA 65K536A20-12.5-20-35TLF	65.536	±20	12.5	-20~+70	35
YA65K53600L142	CCA 65K536A20-12.5-40-35TLF	65.536	±20	12.5	-40~+85	35
YA65K53600L123	CCA 65K536A30-12.5-20-35TLF	65.536	±30	12.5	-20~+70	35
YA65K53600L143	CCA 65K536A30-12.5-40-35TLF	65.536	±30	12.5	-40~+85	35
YA75K00000L122	CCA 75K0A20-12.5-20-35TLF	75.000	±20	12.5	-20~+70	35
YA75K00000L142	CCA 75K0A20-12.5-40-35TLF	75.000	±20	12.5	-40~+85	35
YA75K00000L123	CCA 75K0A30-12.5-20-35TLF	75.000	±30	12.5	-20~+70	35
YA75K00000L143	CCA 75K0A30-12.5-40-35TLF	75.000	±30	12.5	-40~+85	35
YA76K80000L122	CCA 76K8A20-12.5-20-35TLF	76.800	±20	12.5	-20~+70	35
YA76K80000L142	CCA 76K8A20-12.5-40-35TLF	76.800	±20	12.5	-40~+85	35
YA76K80000L123	CCA 76K8A30-12.5-20-35TLF	76.800	±30	12.5	-20~+70	35
YA76K80000L143	CCA 76K8A30-12.5-40-35TLF	76.800	±30	12.5	-40~+85	35
YA96K00000L122	CCA 96K0A20-12.5-20-35TLF	96.000	±20	12.5	-20~+70	35
YA96K00000L142	CCA 96K0A20-12.5-40-35TLF	96.000	±20	12.5	-40~+85	35
YA96K00000L123	CCA 96K0A30-12.5-20-35TLF	96.000	±30	12.5	-20~+70	35
YA96K00000L143	CCA 96K0A30-12.5-40-35TLF	96.000	±30	12.5	-40~+85	35

GENERAL ELECTRICAL CHARACTERISTICS AND VISUAL TESTING

1. LOT CLASSIFICATION : If The Quantity Is 1000 PCS Or More, 1000 PCS Is One Lot
2. Sampling Test Method : Mil-std-105e G-II
3. Test Level
 - A) High Level Defect : AQL 0.065% [200 Pcs]
 - B) Medium Level Defect : AQL 0.25% [50 Pcs]
 - C) Low Level Defect : AQL 0.4% [32 Pcs]
4. Defect Classification
 - A) High Level
 - @ No Frequency
 - @ Mixing
 - @ Leak Defect
 - B) Medium Level - Electrical Characteristic Defect
 - @ Frequency
 - @ Oscillation
 - @ Electrical Current
 - @ Other Electrical Characteristics Defect
 - C) Visual
 - @ Marking
 - @ Welding
 - @ Leads
 - @ Other Visual Defect

Testing method and its standard can be modified depending on the customer's request.

RELIABILITY - MECHANICAL AND ENVIRONMENTALENDURANCE

TEST ITEMS	TEST METHOD AND CONDITIONS	REQUIREMENTS
Vibration	<ol style="list-style-type: none"> 1) Vibration frequency: 10 to 55hz 2) Vibration amplitude: 1.5mm 3) Cycle time: 1~2min(10-55-10hz) 4) Direction: X.Y.Z 5) Duration: 2h/each direction 6) G-force: ≥5g 	Frequency Change: ±10ppm Max. Resistance Change: ≤±15% Rrmax
Shock	3 times free drop from 75cm height to hard wooden board of thickness more than 30mm.	Frequency Change: ±10ppm Max. Resistance Change: ≤±15%Rrmax
Leakage	Put crystal units into a hermetic container and helium for 0.5-0.6. MPA, and keep it for 1h; Check the leakage by a helium leak detector.	Leakage: 1x10 ⁻⁸ mbar.L/ S Max.
Solderability	<ol style="list-style-type: none"> 1) Dip the leads into flux (Rojin methanol) for 3~5s. 2) Dip the leads into 245±5°C 99% SN dipping solution for 5s. 	The dipped part of the Leads should have 95% SN coating.
Soldering Heat Resistance Test	<ol style="list-style-type: none"> 1) Perform electrical characteristics test before starting this procedure. 2) Dip the leads into flux(Rojin methanol) 5±0.5s. 3) Dip the leads into 260±5°C 99% SN dipping Solution for 5s. 4) Take the unit out ,store at room temperature for 30s then measure the electrical characteristics. 	Should pass sealing and visual test. Frequency Change: ±10ppm max.
Leak Test	Use helium leak detector. <ol style="list-style-type: none"> 1) Bombing pressure:5kg/cm² 2) Bombing time: 2 hours 	Gas or air should not be detected.
High Temperature Endurance	The crystal units shall be put in somewhere for 500 hours at temperature of 125°C±5°C,then keep it for 1 to 2 hours under room temperature.	Frequency Change: ±10ppm Max. Resistance Change: ≤±15% Rr Max

RELIABILITY - MECHANICAL AND ENVIRONMENTAL ENDURANCE

TEST ITEMS	TEST METHOD AND CONDITIONS	REQUIREMENTS
Low Temperature Endurance	The crystal units shall be put in somewhere for 500 hours at Temperature of -40°C, then keep it for 1 to 2 hours under room	Frequency Change: ±10ppm Max. Resistance Change: ≅ ±15% Rr Max.
Humidity Endurance	Somewhere at 40°C±5°C in relative humidity of 90%~95% for 72 hours, then keep it for one or two hours under room temperature.	Frequency Change: ±10ppm Max. Resistance Change: ≅ ±15% Rr max
Temperature Cycle	Temperature shift from low(-40°C) to high (100°C, keep 30 minutes), satisfy high(100°C) to low(-40°C, keep 30 minutes), then go up to room temperature for 10 cycles	Frequency Change: ±10ppm Max. Resistance Change: ≅ ±15% Rr Max
Lead Tensity	<ol style="list-style-type: none"> 1) Fix the unit. 2) Apply 2lb of weight axis to the leads. 3) Time:5s 	Should pass sealing and visual test.
Lead Bending	<ol style="list-style-type: none"> 1) Attach 1LB of weight to each of the leads. 2) Bending angle:90°C (from the normal position to 45°C opposite direction). 3) Bending time:3s (each direction). 4) Number of bending: 2 times. 	Should pass sealing and visual test.
Marking Erase	Submerge the unit into IPA (Isopropyl Alcohol) Solution for 10minutes and brush the marking 10 times with a tooth brush.	Marking should not be erased.

SOLDERING REQUIREMENTS – FOR REFERENCE

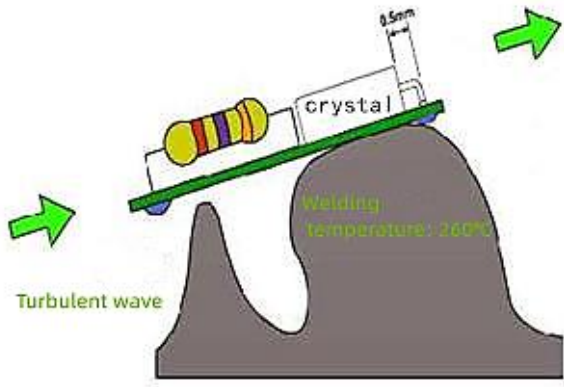

Wave Solder Profile

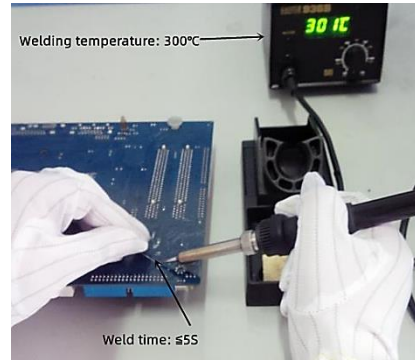

Manual Soldering

PACKAGE– FOR REFERENCE

- Package is made of corrugated paper with thickness of 0.8cm. Package has 16 inner boxes, each box has 10 bag
- Per plastic bag 1000 pieces of Crystal Resonators, Per inner box 10 bag

IMPORTANT NOTES AND DISCLAIMER

1. **ROHS COMPLIANCE:** The levels of RoHS restricted materials in this product are below the maximum concentration values (also referred to as the threshold limits) permitted for such substances, or are used in an exempted application, in accordance with EU RoHS Directive (EU) 2015/863 EC (RoHS3). RoHS Test Report for this product can be obtained at Download Center.
2. **REACH COMPLIANCE:** REACH substances of high concern (SVHCs) information is available for this product. Since the European Chemical Agency (ECHA) has published notice of their intent to frequently revise the SVHC listing for the foreseeable future, REACH Test Report for this product can be obtained at Download Center.
3. All Product parametric performance is indicated in the Electrical Characteristics for the listed herein test conditions, unless otherwise noted. Product performance may not be indicated by the Electrical Characteristics if operated under different conditions.
4. NextGen Component, Inc (*NextGen*) reserves the right to make changes to this document and its products and specifications at any time without notice. Customers should obtain and confirm the latest product information and specifications before final design, purchase or use.
5. *NextGen* makes no warranty, representation or guarantee regarding the suitability of its products for any particular purpose, not does *NextGen* assume any liability for application assistance or customer product design.
6. *NextGen* does not warrant or accept any liability with products which are purchased or used for any unintended or unauthorized application. No license is granted by implication or otherwise under any intellectual property rights of NextGen.
7. *NextGen* products are not authorized for use as critical components in life support devices or systems without express written approval by *NextGen*.
8. *NextGen* requires that customers first obtain an RMA (Returned Merchandise Authorization) number prior to returning any products. Returns must be made within 30 days of the date of invoice, be in the original packaging, unused and like-new condition. At the time of quoting or purchasing, a product may say that it is Non-Cancelable/ Non-Returnable (NCNR). These products are not returnable and not refundable.