



<b>SPECIFICATION SHEET NO.</b>	R1125- RF11N102J500GB	
<b>ORIGINAL MFG/PART NO.</b>	Aillen Capacitors/RF1111N102J500GB	
<b>NEXTGEN PART CODE</b>	RF11N102J500GB	Indicate This Code For <a href="#">RFQ/Order</a>
<b>DATE</b>	Nov. 25, 2024	
<b>REVISION</b>	A5	Updated With Most Recent Data
<b>DESCRIPTION AND MAIN PARAMETRICS</b>	<p>High Q/Low ESR Multilayer Ceramic Chip Capacitors (MLCC), RF Series</p> <p>Case 1111 Metric 2828, Dimension L2.79*W2.79*H1.78mm</p> <p>Thickness: 1.78mm Max. Dielectric NPO, Capacitance 1000pF, Tolerance ±5%, Rated Voltage 50V</p> <p>Operating Temp. Range -55°C ~+125°C</p> <p>Package in Tape/Reel, 2,000pcs/Reel</p> <p>REACH/RoHS/RoHS III Compliant</p>	
<b>CUSTOMER</b>		
<b>CUSTOMER PART NUMBER</b>		
<b>CROSS REF. PART NUMBER</b>		
<b>MEMO</b>		

<b>VENDOR APPROVE</b>		
Issued/Checked/Approved		
		
Effective Date: Nov. 25 2024		

<b>CUSTOMER APPROVE</b>
DATE:

## DESCRIPTION

MLCC consists of a conducting material and electrodes. To manufacture a chip-type SMT and achieve miniaturization, high density and high efficiency, ceramic condensers are used. RF series MLCC is used at high frequencies generally have a small temperature coefficient of capacitance, typical within the  $\pm 30\text{ppm}/^\circ\text{C}$  required for NP0 (COG) classification and have excellent conductivity internal electrode.



*Image shown is a representation only.*

*Exact specifications should be obtained from the product dimension.*

## MAIN FEATURE

- Rated Voltage Range 6.3V ~ 500V
- High Q And Low ESR Performance At High Frequency
- Ultra Low Capacitance To 0.1pF
- Can Offer High Precision Tolerance To  $\pm 0.05\text{pF}$
- Quality Improvement Of Telephone Calls For Low Power Loss And Better Performance.
- REACH/RoHS/RoHS III Compliant



## APPLICATION

- Telecommunication products & equipment: Mobile phone, WLAN, Base station.
- RF module: Power amplifier, VCO
- Tuners

## ELECTRICAL CHARACTERISTICS

- See Page 4~Page 8 For Different Part Code And Rated Voltage.
- All Products Parameters are Subject To NextGen Components' Final Confirmation.

**HOW TO ORDER**

- Please Follow Up Part Code Guide And Indicate NextGen Part Code RF11N102J500GB For RFQ and Order.

**RFQ**  
Request For Quotation

**PART CODE GUIDE**

CODE	NAME	KEY SPECIFICATION OPTION
RF	Product code	High Q/Low ESR Multilayer Ceramic Chip Capacitors (MLCC), RF Series
11	Size Code	01: 0201 (0603): L0.60*W0.30mm; 02: 0402 (1005): L1.00*W0.50mm 03: 0603 (1608): L1.60*W0.80mm; 04: 01005 (0402): L0.40*W0.20mm 05: 0805 (2012): L2.00*W1.25mm; 11: 1111 (2828): L2.79*W2.79mm; 14: 0505 (1414): L1.40*W1.40mm
N	Temperature Coefficient	N: NP0 (COG)
102	Capacitance	Two significant digits followed by number of Zero, The 3rd digit signifies the multiplying factor, and letter R is decimal point. 0R7: 0.7pF; 1R5: 1.5pF; 8R2: 8.2pF; 102: 1000pF; 330: 33pF
J	Tolerance	A: ±0.05pF; B: ±0.1pF; C: ±0.25pF; D: ±0.5pF; F: ±1%; G: ±2%; J: ±5%
500	Rated Voltage	Two significant digits followed by No. of zeros. "R" is in place of decimal point. e.g.: 6R3: 6.3VDC; 101: 100 VDC; 201: 200 VDC; 250: 25 VDC; 251: 250 VDC 500: 50 VDC; 501: 500 VDC;
G	Thickness	G: 1.78mm, See Page 9 (T's Symbol) for Different part code
B	Package	A: 1Kpcs/Reel; B: 2Kpcs/Reel; C: 3Kpcs/Reel; D: 4Kpcs/Reel; E: 15Kpcs/Reel; I: 10Kpcs/Reel
( )	Internal Control	Blank: N/A; XX: Letter A~Z, a~z or digits (0~9) for Special/Custom Parameters

**ELECTRICAL CHARACTERISTICS – 25V NP0 (COG) FOR DIFFERENT PART CODE**

NEXTGEN PART CODE	TEMP. COEFFICIENT	CAPACITANCE	TOLERANCE	VOLTAGE	THICKNESS (MAX.)	OPERATING TEMP. RANGE	CAPACITANCE CHARACTERISTIC
	-	-	-	V	mm	°C	-
RF01N150J250LE	NP0 (COG)	15 pF	±5%	25	0.33	-55 ~+125	±30ppm/°C
RF01N1R0B250LE	NP0 (COG)	1 pF	±0.1pF	25	0.33	-55 ~+125	±30ppm/°C
RF01N1R2B250LE	NP0 (COG)	1.2 pF	±0.1pF	25	0.33	-55 ~+125	±30ppm/°C
RF01N1R5B250LE	NP0 (COG)	1.5 pF	±0.1pF	25	0.33	-55 ~+125	±30ppm/°C
RF01N1R8B250LE	NP0 (COG)	1.8 pF	±0.1pF	25	0.33	-55 ~+125	±30ppm/°C
RF01N2R0B250LE	NP0 (COG)	2 pF	±0.1pF	25	0.33	-55 ~+125	±30ppm/°C
RF01N2R4B250LE	NP0 (COG)	2.4 pF	±0.1pF	25	0.33	-55 ~+125	±30ppm/°C
RF01N2R7B250LE	NP0 (COG)	2.7 pF	±0.1pF	25	0.33	-55 ~+125	±30ppm/°C
RF01N330J250LE	NP0 (COG)	33 pF	±5%	25	0.33	-55 ~+125	±30ppm/°C
RF01N3R0B250LE	NP0 (COG)	3 pF	±0.1pF	25	0.33	-55 ~+125	±30ppm/°C
RF01N3R3B250LE	NP0 (COG)	3.3 pF	±0.1pF	25	0.33	-55 ~+125	±30ppm/°C
RF01N4R0B250LE	NP0 (COG)	4 pF	±0.1pF	25	0.33	-55 ~+125	±30ppm/°C
RF01N4R7B250LE	NP0 (COG)	4.7 pF	±0.1pF	25	0.33	-55 ~+125	±30ppm/°C
RF01N5R6B250LE	NP0 (COG)	5.6 pF	±0.1pF	25	0.33	-55 ~+125	±30ppm/°C
RF01N8R2B250LE	NP0 (COG)	8.2 pF	±0.1pF	25	0.33	-55 ~+125	±30ppm/°C
RF01N9R0B250LE	NP0 (COG)	9 pF	±0.1pF	25	0.33	-55 ~+125	±30ppm/°C
RF01N0R3A250LE	NP0 (COG)	0.3 pF	±0.05pF	25	0.33	-55 ~+125	±30ppm/°C
RF01N0R4A250LE	NP0 (COG)	0.4 pF	±0.05pF	25	0.33	-55 ~+125	±30ppm/°C
RF01N0R5B250LE	NP0 (COG)	0.5 pF	±0.1pF	25	0.33	-55 ~+125	±30ppm/°C
RF01N0R6B250LE	NP0 (COG)	0.6 pF	±0.1pF	25	0.33	-55 ~+125	±30ppm/°C



**ELECTRICAL CHARACTERISTICS – 50V NP0 (COG) FOR DIFFERENT PART CODE**

NEXTGEN PART CODE	TEMP. COEFFICIENT	CAPACITANCE	TOLERANCE	VOLTAGE	THICKNESS (MAX.)	OPERATING TEMP. RANGE	CAPACITANCE CHARACTERISTIC
	-	-	-	V	mm	°C	-
RF01N0R2A500LE	NP0 (COG)	0.2 pF	±0.05pF	50	0.33	-55 ~+125	±30ppm/°C
RF01N100J500LE	NP0 (COG)	10 pF	±5%	50	0.33	-55 ~+125	±30ppm/°C
RF01N180J500LE	NP0 (COG)	18 pF	±5%	50	0.33	-55 ~+125	±30ppm/°C
RF01N1R3B500LE	NP0 (COG)	1.3 pF	±0.1pF	50	0.33	-55 ~+125	±30ppm/°C
RF01N1R8B500LE	NP0 (COG)	1.8 pF	±0.1pF	50	0.33	-55 ~+125	±30ppm/°C
RF01N2R0B500LE	NP0 (COG)	2 pF	±0.1pF	50	0.33	-55 ~+125	±30ppm/°C
RF02N0R2A500NI	NP0 (COG)	0.2 pF	±0.05pF	50	0.55	-55 ~+125	±30ppm/°C
RF02N0R3A500NI	NP0 (COG)	0.3 pF	±0.05pF	50	0.55	-55 ~+125	±30ppm/°C
RF02N0R5A500NI	NP0 (COG)	0.5 pF	±0.05pF	50	0.55	-55 ~+125	±30ppm/°C
RF02N0R5B500NI	NP0 (COG)	0.5 pF	±0.1pF	50	0.55	-55 ~+125	±30ppm/°C
RF02N0R8A500NI	NP0 (COG)	0.8 pF	±0.05pF	50	0.55	-55 ~+125	±30ppm/°C
RF02N0R8B500NI	NP0 (COG)	0.8 pF	±0.1pF	50	0.55	-55 ~+125	±30ppm/°C
RF02N0R9B500NI	NP0 (COG)	0.9 pF	±0.1pF	50	0.55	-55 ~+125	±30ppm/°C
RF02N100C500NI	NP0 (COG)	10 pF	±0.25pF	50	0.55	-55 ~+125	±30ppm/°C
RF02N100J500NI	NP0 (COG)	10 pF	±5%	50	0.55	-55 ~+125	±30ppm/°C
RF02N120J500NI	NP0 (COG)	12 pF	±5%	50	0.55	-55 ~+125	±30ppm/°C
RF02N150F500NI	NP0 (COG)	15 pF	±1%	50	0.55	-55 ~+125	±30ppm/°C
RF02N150J500NI	NP0 (COG)	15 pF	±5%	50	0.55	-55 ~+125	±30ppm/°C
RF02N1R0A500NI	NP0 (COG)	1 pF	±0.05pF	50	0.55	-55 ~+125	±30ppm/°C

**ELECTRICAL CHARACTERISTICS – 50V NP0 (COG) FOR DIFFERENT PART CODE**

NEXTGEN PART CODE	TEMP. COEFFICIENT	CAPACITANCE	TOLERANCE	VOLTAGE	THICKNESS (MAX.)	OPERATING TEMP. RANGE	CAPACITANCE CHARACTERISTIC
	-	-	-	V	mm	°C	-
RF02N1R0C500NI	NP0 (COG)	1 pF	±0.25pF	50	0.55	-55 ~+125	±30ppm/°C
RF02N1R5B500NI	NP0 (COG)	1.5 pF	±0.1pF	50	0.55	-55 ~+125	±30ppm/°C
RF02N1R6B500NI	NP0 (COG)	1.6 pF	±0.1pF	50	0.55	-55 ~+125	±30ppm/°C
RF02N1R8C500NI	NP0 (COG)	1.8 pF	±0.25pF	50	0.55	-55 ~+125	±30ppm/°C
RF02N200J500NI	NP0 (COG)	20 pF	±5%	50	0.55	-55 ~+125	±30ppm/°C
RF02N220J500NI	NP0 (COG)	22 pF	±5%	50	0.55	-55 ~+125	±30ppm/°C
RF02N270J500NI	NP0 (COG)	27 pF	±5%	50	0.55	-55 ~+125	±30ppm/°C
RF02N2R0B500NI	NP0 (COG)	2 pF	±0.1pF	50	0.55	-55 ~+125	±30ppm/°C
RF02N2R2B500NI	NP0 (COG)	2.2 pF	±0.1pF	50	0.55	-55 ~+125	±30ppm/°C
RF02N2R4B500NI	NP0 (COG)	2.4 pF	±0.1pF	50	0.55	-55 ~+125	±30ppm/°C
RF02N2R7B500NI	NP0 (COG)	2.7 pF	±0.1pF	50	0.55	-55 ~+125	±30ppm/°C
RF02N330J500NI	NP0 (COG)	33 pF	±5%	50	0.55	-55 ~+125	±30ppm/°C
RF02N3R3A500NI	NP0 (COG)	3.3 pF	±0.05pF	50	0.55	-55 ~+125	±30ppm/°C
RF02N3R3B500NI	NP0 (COG)	3.3 pF	±0.1pF	50	0.55	-55 ~+125	±30ppm/°C
RF02N3R3C500NI	NP0 (COG)	3.3 pF	±0.25pF	50	0.55	-55 ~+125	±30ppm/°C
RF02N3R6B500NI	NP0 (COG)	3.6 pF	±0.1pF	50	0.55	-55 ~+125	±30ppm/°C
RF02N3R9C500NI	NP0 (COG)	3.9 pF	±0.25pF	50	0.55	-55 ~+125	±30ppm/°C
RF02N470J500NI	NP0 (COG)	47 pF	±5%	50	0.55	-55 ~+125	±30ppm/°C
RF02N4R7B500NI	NP0 (COG)	4.7 pF	±0.1pF	50	0.55	-55 ~+125	±30ppm/°C
RF02N5R6C500NI	NP0 (COG)	5.6 pF	±0.25pF	50	0.55	-55 ~+125	±30ppm/°C

**ELECTRICAL CHARACTERISTICS – 50V NP0 (COG) FOR DIFFERENT PART CODE**

NEXTGEN PART CODE	TEMP. COEFFICIENT	CAPACITANCE	TOLERANCE	VOLTAGE	THICKNESS (MAX.)	OPERATING TEMP. RANGE	CAPACITANCE CHARACTERISTIC
	-						
RF02N6R8B500NI	NP0 (COG)	6.8 pF	±0.1pF	50	0.55	-55 ~+125	±30ppm/°C
RF02N6R8C500NI	NP0 (COG)	6.8 pF	±0.25pF	50	0.55	-55 ~+125	±30ppm/°C
RF02N8R0C500NI	NP0 (COG)	8 pF	±0.25pF	50	0.55	-55 ~+125	±30ppm/°C
RF02N8R0D500NI	NP0 (COG)	8 pF	±0.5pF	50	0.55	-55 ~+125	±30ppm/°C
RF02N8R2C500NI	NP0 (COG)	8.2 pF	±0.25pF	50	0.55	-55 ~+125	±30ppm/°C
RF02N0R4A500NI	NP0 (COG)	0.4 pF	±0.05pF	50	0.55	-55 ~+125	±30ppm/°C
RF02N0R6A500NI	NP0 (COG)	0.6 pF	±0.05pF	50	0.55	-55 ~+125	±30ppm/°C
RF02N0R7A500NI	NP0 (COG)	0.7 pF	±0.05pF	50	0.55	-55 ~+125	±30ppm/°C
RF03N1R5C500SD	NP0 (COG)	1.5 pF	±0.25pF	50	0.87	-55 ~+125	±30ppm/°C
<b>RF11N102J500GB</b>	NP0 (COG)	1000 pF	±5%	50	1.78	-55 ~+125	±30ppm/°C

**ELECTRICAL CHARACTERISTICS – 250V NP0 (COG) FOR DIFFERENT PART CODE**

NEXTGEN PART CODE	TEMP. COEFFICIENT	CAPACITANCE	TOLERANCE	VOLTAGE	THICKNESS (MAX.)	OPERATING TEMP. RANGE	CAPACITANCE CHARACTERISTIC
	-						
RF03N330J251SD	NP0 (COG)	33 pF	±5%	250	0.87	-55 ~+125	±30ppm/°C



**DIMENSION** (Unit: mm)

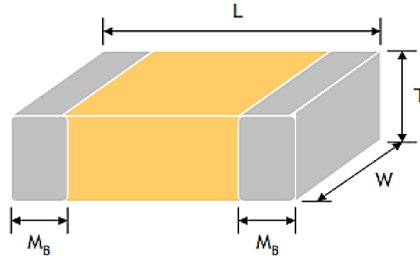

SIZE CODE	METRIC CODE	L	W	T (SYMBOL )		SOLDERING METHOD	M B
1005	0402	0.40±0.02	0.20±0.02	0.20±0.02	V	#	0.10+0.03
0201	0603	0.60±0.03	0.30±0.03	0.3±0.03	L	#	0.15+0.05
0402	1005	1.00±0.05	0.50±0.05	0.50±0.05	N	#	0.25 +0.05/-0.10
0603	1608	1.60±0.10	0.80±0.10	0.80±0.07	S		0.40±0.15
		1.60 +0.15/-0.10	0.80 +0.15/-0.10	0.50±0.10	H		
0805	2012	2.00±0.15	1.25±0.10	0.60±0.10	A		0.50±0.20
		2.00±0.20	1.25±0.20	0.85±0.10	T		
0505	1414	1.40 +0.38/-0.25	1.40±0.38	1.15±0.15	J	#	0.25 +0.25/-0.13
1111	2828	2.79 +0.51/-0.25	2.79±0.38	≤ 1.78	G	#	0.38±0.25

# Reflow soldering only is recommended.

**GENERAL ELECTRICAL CHARACTERISTICS**

DIELECTRIC	NPO (COG)
Size	01005, 0201, 0402, 0505, 0603, 0805, 1111
Capacitance range*	0.1pF to 1000pF
Capacitance Tolerance	Cap≤5pF: A (±0.05pF), B (±0.1pF), C (±0.25pF) 5pF<Cap<10pF: B (±0.1pF), C (±0.25pF), D (±0.5pF) Cap≥10pF: F (±1%), G (±2%), J (±5%)
Rated Voltage	6.3V, 10V, 25V, 50V, 100V, 200V, 250V, 500V
Q*	01005, 0201, 0402/25V~50V: Cap<30pF:Q≥400+20C; Cap≥30pF:Q≥1000 0402/100V~200V, 0603, 0805, 0505, 1111: Cap<30pF:Q≥800+20C; Cap≥30pF:Q≥1400
Insulation resistance at Ur	≥10GΩ or RxC≥100Ω-F whichever is smaller.
Operating Temperature	-55 ~+125°C
Capacitance change	±30ppm/° C; 0201Cap≥22pF, ±60ppm/° C
Termination	Ni/Sn (lead-free termination)

Note:

- 1) \* Measured at the condition of 30~70% related humidity.
- 2) Apply 1.0±0.2Vrms, 1.0MHz±10% for Cap≤1000pF and 1.0±0.2Vrms, 1.0kHz±10% for Cap>1000pF, 25°C at ambient temperature.

**CAPACITANCE RANGE - NP0 (COG) DIELECTRIC – SIZE 01005**

Table 1-A

SIZE	01005		TOLERANCE
	16	25	
RATED VOLTAGE (VDC)			
0.2pF (0R2)	V	V	A, B
0.3pF (0R3)	V	V	A, B
0.4pF (0R4)	V	V	A, B
0.5pF (0R5)	V	V	A, B, C
0.6pF (0R6)	V	V	A, B, C
0.7pF (0R7)	V	V	A, B, C
0.75pF (R75)	V	V	A, B, C
0.8pF (0R8)	V	V	A, B, C
0.9pF (0R9)	V	V	A, B, C
1.0pF (1R0)	V	V	A, B, C
1.2pF (1R2)	V	V	A, B, C
1.5pF (1R5)	V	V	A, B, C
1.8pF (1R8)	V	V	A, B, C
2.0pF (2R0)	V	V	A, B, C
2.2pF (2R2)	V	V	A, B, C
2.7pF (2R7)	V	V	A, B, C
3.0pF (3R0)	V	V	A, B, C
3.3pF (3R3)	V	V	A, B, C
3.9pF (3R9)	V	V	A, B, C
4.0pF (4R0)	V	V	A, B, C
4.7pF (4R7)	V	V	A, B, C
5.0pF (5R0)	V	V	A, B, C
5.6pF (5R6)	V	V	B, C, D
6.0pF (6R0)	V	V	B, C, D
6.8pF (6R8)	V		B, C, D
7.0pF (7R0)	V		B, C, D
8.0pF (8R0)	V		B, C, D
8.2pF (8R2)	V		B, C, D
9.0pF (9R0)	V		B, C, D
10pF (100)	V	V	C, D, G
12pF (120)	V	V	J
15pF (150)	V	V	J
20pF (200)	V	V	J
22pF (220)	V	V	J

**CAPACITANCE RANGE - NP0 (COG) DIELECTRIC - SIZE 0201, 0402**

Table 1-B

SIZE	0201				0402				TOLERANCE
	RATED VOLTAGE (VDC)	6.3	10	25	50	25	50	100	
0.1pF (0R1)	L	L	L	L	N	N	N	N	B
0.2pF (0R2)	L	L	L	L	N	N	N	N	A, B
0.3pF (0R3)	L	L	L	L	N	N	N	N	A, B
0.4pF (0R4)	L	L	L	L	N	N	N	N	A, B
0.5pF (0R5)	L	L	L	L	N	N	N	N	A, B, C
0.6pF (0R6)	L	L	L	L	N	N	N	N	A, B, C
0.7pF (0R7)	L	L	L	L	N	N	N	N	A, B, C
0.75pF (R75)	L	L	L	L	N	N	N	N	A, B, C
0.8pF (0R8)	L	L	L	L	N	N	N	N	A, B, C
0.9pF (0R9)	L	L	L	L	N	N	N	N	A, B, C
1.0pF (1R0)	L	L	L	L	N	N	N	N	A, B, C
1.1pF (1R1)	L	L	L	L	N	N	N	N	A, B, C
1.2pF (1R2)	L	L	L	L	N	N	N	N	A, B, C
1.3pF (1R3)	L	L	L	L	N	N	N	N	A, B, C
1.4pF (1R4)	L	L	L	L	N	N	N	N	A, B, C
1.5pF (1R5)	L	L	L	L	N	N	N	N	A, B, C
1.6pF (1R6)	L	L	L	L	N	N	N	N	A, B, C
1.7pF (1R7)	L	L	L	L	N	N	N	N	A, B, C
1.8pF (1R8)	L	L	L	L	N	N	N	N	A, B, C
1.9pF (1R9)	L	L	L	L	N	N	N	N	A, B, C
2.0pF (2R0)	L	L	L	L	N	N	N	N	A, B, C
2.1pF (2R1)	L	L	L	L	N	N	N	N	A, B, C
2.2pF (2R2)	L	L	L	L	N	N	N	N	A, B, C
2.3pF (2R3)	L	L	L	L	N	N	N	N	A, B, C
2.4pF (2R4)	L	L	L	L	N	N	N	N	A, B, C
2.5pF (2R5)	L	L	L	L	N	N	N	N	A, B, C
2.6pF (2R6)	L	L	L	L	N	N	N	N	A, B, C
2.7pF (2R7)	L	L	L	L	N	N	N	N	A, B, C
2.8pF (2R8)	L	L	L	L	N	N	N	N	A, B, C
2.9pF (2R9)	L	L	L	L	N	N	N	N	A, B, C
3.0pF (3R0)	L	L	L	L	N	N	N	N	A, B, C
3.1pF (3R1)	L	L	L	L	N	N	N	N	A, B, C
3.2pF (3R2)	L	L	L	L	N	N	N	N	A, B, C
3.3pF (3R3)	L	L	L	L	N	N	N	N	A, B, C
3.4pF (3R4)	L	L	L	L	N	N	N	N	A, B, C

**CAPACITANCE RANGE - NP0 (COG) DIELECTRIC - SIZE 0201, 0402**

Table 1-C

SIZE	0201				0402				TOLERANCE
	RATED VOLTAGE (VDC)	6.3	10	25	50	25	50	100	
3.5pF (3R5)	L	L	L	L	N	N	N	N	A, B, C
3.6pF (3R6)	L	L	L	L	N	N	N	N	A, B, C
3.7pF (3R7)	L	L	L	L	N	N	N	N	A, B, C
3.8pF (3R8)	L	L	L	L	N	N	N	N	A, B, C
3.9pF (3R9)	L	L	L	L	N	N	N	N	A, B, C
4.0pF (4R0)	L	L	L	L	N	N	N	N	A, B, C
4.1pF (4R1)	L	L	L	L	N	N	N	N	A, B, C
4.2pF (4R2)	L	L	L	L	N	N	N	N	A, B, C
4.3pF (4R3)	L	L	L	L	N	N	N	N	A, B, C
4.4pF (4R4)	L	L	L	L	N	N	N	N	A, B, C
4.5pF (4R5)	L	L	L	L	N	N	N	N	A, B, C
4.6pF (4R6)	L	L	L	L	N	N	N	N	A, B, C
4.7pF (4R7)	L	L	L	L	N	N	N	N	A, B, C
4.8pF (4R8)	L	L	L	L	N	N	N	N	A, B, C
4.9pF (4R9)	L	L	L	L	N	N	N	N	A, B, C
5.0pF (5R0)	L	L	L	L	N	N	N	N	A, B, C
5.1pF (5R1)	L	L	L	L	N	N	N	N	B, C, D
5.2pF (5R2)	L	L	L	L	N	N	N	N	B, C, D
5.3pF (5R3)	L	L	L	L	N	N	N	N	B, C, D
5.4pF (5R4)	L	L	L	L	N	N	N	N	B, C, D
5.5pF (5R5)	L	L	L	L	N	N	N	N	B, C, D
5.6pF (5R6)	L	L	L	L	N	N	N	N	B, C, D
5.7pF (5R7)	L	L	L	L	N	N	N	N	B, C, D
5.8pF (5R8)	L	L	L	L	N	N	N	N	B, C, D
5.9pF (5R9)	L	L	L	L	N	N	N	N	B, C, D
6.0pF (6R0)	L	L	L	L	N	N	N	N	B, C, D
6.1pF (6R1)	L	L	L	L	N	N	N	N	B, C, D
6.2pF (6R2)	L	L	L	L	N	N	N	N	B, C, D
6.3pF (6R3)	L	L	L	L	N	N	N	N	B, C, D
6.4pF (6R4)	L	L	L	L	N	N	N	N	B, C, D
6.5pF (6R5)	L	L	L	L	N	N	N	N	B, C, D
6.6pF (6R6)	L	L	L	L	N	N	N	N	B, C, D
6.7pF (6R7)	L	L	L	L	N	N	N	N	B, C, D
6.8pF (6R8)	L	L	L	L	N	N	N	N	B, C, D
6.9pF (6R9)	L	L	L	L	N	N	N	N	B, C, D

**CAPACITANCE RANGE - NP0 (COG) DIELECTRIC - SIZE 0201, 0402**

Table 1-D

SIZE	0201				0402				TOLERANCE
	6.3	10	25	50	25	50	100	200	
7.0pF (7R0)	L	L	L	L	N	N	N	N	B, C, D
7.1pF (7R1)	L	L	L	L	N	N	N	N	B, C, D
7.2pF (7R2)	L	L	L	L	N	N	N	N	B, C, D
7.3pF (7R3)	L	L	L	L	N	N	N	N	B, C, D
7.4pF (7R4)	L	L	L	L	N	N	N	N	B, C, D
7.5pF (7R5)	L	L	L	L	N	N	N	N	B, C, D
7.6pF (7R6)	L	L	L	L	N	N	N	N	B, C, D
7.7pF (7R7)	L	L	L	L	N	N	N	N	B, C, D
7.8pF (7R8)	L	L	L	L	N	N	N	N	B, C, D
7.9pF (7R9)	L	L	L	L	N	N	N	N	B, C, D
8.0pF (8R0)	L	L	L	L	N	N	N	N	B, C, D
8.1pF (8R1)	L	L	L	L	N	N	N	N	B, C, D
8.2pF (8R2)	L	L	L	L	N	N	N	N	B, C, D
8.3pF (8R3)	L	L	L	L	N	N	N	N	B, C, D
8.4pF (8R4)	L	L	L	L	N	N	N	N	B, C, D
8.5pF (8R5)	L	L	L	L	N	N	N	N	B, C, D
8.6pF (8R6)	L	L	L	L	N	N	N	N	B, C, D
8.7pF (8R7)	L	L	L	L	N	N	N	N	B, C, D
8.8pF (8R8)	L	L	L	L	N	N	N	N	B, C, D
8.9pF (8R9)	L	L	L	L	N	N	N	N	B, C, D
9.0pF (9R0)	L	L	L	L	N	N	N	N	B, C, D
9.1pF (9R1)	L	L	L	L	N	N	N	N	B, C, D
9.2pF (9R2)	L	L	L	L	N	N	N	N	B, C, D
9.3pF (9R3)	L	L	L	L	N	N	N	N	B, C, D
9.4pF (9R4)	L	L	L	L	N	N	N	N	B, C, D
9.5pF (9R5)	L	L	L	L	N	N	N	N	B, C, D
9.6pF (9R6)	L	L	L	L	N	N	N	N	B, C, D
9.7pF (9R7)	L	L	L	L	N	N	N	N	B, C, D
9.8pF (9R8)	L	L	L	L	N	N	N	N	B, C, D
9.9pF (9R9)	L	L	L	L	N	N	N	N	B, C, D
10pF (100)	L	L	L	L	N	N	N	N	F, G, J
11pF (110)	L	L	L	L	N	N	N	N	F, G, J
12pF (120)	L	L	L	L	N	N	N	N	F, G, J
13pF (130)	L	L	L	L	N	N	N	N	F, G, J
15pF (150)	L	L	L	L	N	N	N	N	F, G, J

**CAPACITANCE RANGE - NP0 (COG) DIELECTRIC - SIZE 0201, 0402**

Table 1-E

SIZE	0201				0402				TOLERANCE
	6.3	10	25	50	25	50	100	200	
RATED VOLTAGE (VDC)									
16pF (160)	L	L	L	L	N	N	N	N	F, G, J
18pF (180)	L	L	L	L	N	N	N	N	F, G, J
20pF (200)	L	L	L	L	N	N	N	N	F, G, J
22pF (220)	L	L	L		N	N	N	N	F, G, J
24pF (240)	L	L	L		N	N	N	N	F, G, J
27pF (270)	L	L	L		N	N	N	N	F, G, J
30pF (300)	L	L	L		N	N	N	N	F, G, J
33pF (330)	L	L	L		N	N	N	N	F, G, J
36pF (360)					N	N	N		F, G, J
39pF (390)					N	N	N		F, G, J
43pF (430)					N	N	N		F, G, J
47pF (470)					N	N	N		F, G, J
56pF (560)					N	N	N		F, G, J
68pF (680)					N	N			F, G, J
82pF (820)					N	N			F, G, J
100pF (101)					N	N			F, G, J

**CAPACITANCE RANGE - NP0 DIELECTRIC SIZE 0505, 0603, 0805**

Table 1-F

SIZE	0505			0603			0805				TOLERANCE
	50	100	250	50	100	250	50	100	250	500	
RATED VOLTAGE (VDC)											
0.1pF (0R1)				H	H	H					A, B
0.2pF (0R2)				H	H	H	A	A	A	A	A, B
0.3pF (0R3)				S	S	S	T	T	T	T	A, B
0.4pF (0R4)	J	J	J	S	S	S	T	T	T	T	A, B
0.5pF (0R5)	J	J	J	S	S	S	T	T	T	T	A, B, C
0.6pF (0R6)	J	J	J	S	S	S	T	T	T	T	A, B, C
0.7pF (0R7)	J	J	J	S	S	S	T	T	T	T	A, B, C
0.8pF (0R8)	J	J	J	S	S	S	T	T	T	T	A, B, C
0.9pF (0R9)	J	J	J	S	S	S	T	T	T	T	A, B, C
1.0pF (1R0)	J	J	J	S	S	S	T	T	T	T	A, B, C
1.1pF (1R1)	J	J	J	S	S	S	T	T	T	T	A, B, C
1.2pF (1R2)	J	J	J	S	S	S	T	T	T	T	A, B, C
1.3pF (1R3)	J	J	J	S	S	S	T	T	T	T	A, B, C
1.4pF (1R4)	J	J	J	S	S	S	T	T	T	T	A, B, C

**CAPACITANCE RANGE** -NPO (COG) DIELECTRIC - SIZE 0505, 0603, 0805

Table 1-G

SIZE	0505			0603			0805				TOLERANCE
	RATED VOLTAGE (VDC)	50	100	250	50	100	250	50	100	250	
1.5pF (1R5)	J	J	J	S	S	S	T	T	T	T	A, B, C
1.6pF (1R6)	J	J	J	S	S	S	T	T	T	T	A, B, C
1.7pF (1R7)	J	J	J	S	S	S	T	T	T	T	A, B, C
1.8pF (1R8)	J	J	J	S	S	S	T	T	T	T	A, B, C
1.9pF (1R9)	J	J	J	S	S	S	T	T	T	T	A, B, C
2.0pF (2R0)	J	J	J	S	S	S	T	T	T	T	A, B, C
2.1pF (2R1)	J	J	J	S	S	S	T	T	T	T	A, B, C
2.2pF (2R2)	J	J	J	S	S	S	T	T	T	T	A, B, C
2.3pF (2R3)	J	J	J	S	S	S	T	T	T	T	A, B, C
2.4pF (2R4)	J	J	J	S	S	S	T	T	T	T	A, B, C
2.5pF (2R5)	J	J	J	S	S	S	T	T	T	T	A, B, C
2.6pF (2R6)	J	J	J	S	S	S	T	T	T	T	A, B, C
2.7pF (2R7)	J	J	J	S	S	S	T	T	T	T	A, B, C
2.8pF (2R8)	J	J	J	S	S	S	T	T	T	T	A, B, C
2.9pF (2R9)	J	J	J	S	S	S	T	T	T	T	A, B, C
3.0pF (3R0)	J	J	J	S	S	S	T	T	T	T	A, B, C
3.1pF (3R1)	J	J	J	S	S	S	T	T	T	T	A, B, C
3.2pF (3R2)	J	J	J	S	S	S	T	T	T	T	A, B, C
3.3pF (3R3)	J	J	J	S	S	S	T	T	T	T	A, B, C
3.4pF (3R4)	J	J	J	S	S	S	T	T	T	T	A, B, C
3.5pF (3R5)	J	J	J	S	S	S	T	T	T	T	A, B, C
3.6pF (3R6)	J	J	J	S	S	S	T	T	T	T	A, B, C
3.7pF (3R7)	J	J	J	S	S	S	T	T	T	T	A, B, C
3.8pF (3R8)	J	J	J	S	S	S	T	T	T	T	A, B, C
3.9pF (3R9)	J	J	J	S	S	S	T	T	T	T	A, B, C
4.0pF (4R0)	J	J	J	S	S	S	T	T	T	T	A, B, C
4.1pF (4R1)	J	J	J	S	S	S	T	T	T	T	A, B, C
4.2pF (4R2)	J	J	J	S	S	S	T	T	T	T	A, B, C
4.3pF (4R3)	J	J	J	S	S	S	T	T	T	T	A, B, C
4.4pF (4R4)	J	J	J	S	S	S	T	T	T	T	A, B, C
4.5pF (4R5)	J	J	J	S	S	S	T	T	T	T	A, B, C
4.6pF (4R6)	J	J	J	S	S	S	T	T	T	T	A, B, C
4.7pF (4R7)	J	J	J	S	S	S	T	T	T	T	A, B, C
4.8pF (4R8)	J	J	J	S	S	S	T	T	T	T	A, B, C



**CAPACITANCE RANGE** -NPO (COG) DIELECTRIC - SIZE 0505, 0603, 0805

Table 1-H

SIZE	0505			0603			0805				TOLERANCE
	50	100	250	50	100	250	50	100	250	500	
4.9pF (4R9)	J	J	J	S	S	S	T	T	T	T	A, B, C
5.0pF (5R0)	J	J	J	S	S	S	T	T	T	T	A, B, C
5.1pF (5R1)	J	J	J	S	S	S	T	T	T	T	B, C, D
5.2pF (5R2)	J	J	J	S	S	S	T	T	T	T	B, C, D
5.3pF (5R3)	J	J	J	S	S	S	T	T	T	T	B, C, D
5.4pF (5R4)	J	J	J	S	S	S	T	T	T	T	B, C, D
5.5pF (5R5)	J	J	J	S	S	S	T	T	T	T	B, C, D
5.6pF (5R6)	J	J	J	S	S	S	T	T	T	T	B, C, D
5.7pF (5R7)	J	J	J	S	S	S	T	T	T	T	B, C, D
5.8pF (5R8)	J	J	J	S	S	S	T	T	T	T	B, C, D
5.9pF (5R9)	J	J	J	S	S	S	T	T	T	T	B, C, D
6.0pF (6R0)	J	J	J	S	S	S	T	T	T	T	B, C, D
6.1pF (6R1)	J	J	J	S	S	S	T	T	T	T	B, C, D
6.2pF (6R2)	J	J	J	S	S	S	T	T	T	T	B, C, D
6.3pF (6R3)	J	J	J	S	S	S	T	T	T	T	B, C, D
6.4pF (6R4)	J	J	J	S	S	S	T	T	T	T	B, C, D
6.5pF (6R5)	J	J	J	S	S	S	T	T	T	T	B, C, D
6.6pF (6R6)	J	J	J	S	S	S	T	T	T	T	B, C, D
6.7pF (6R7)	J	J	J	S	S	S	T	T	T	T	B, C, D
6.8pF (6R8)	J	J	J	S	S	S	T	T	T	T	B, C, D
6.9pF (6R9)	J	J	J	S	S	S	T	T	T	T	B, C, D
7.0pF (7R0)	J	J	J	S	S	S	T	T	T	T	B, C, D
7.1pF (7R1)	J	J	J	S	S	S	T	T	T	T	B, C, D
7.2pF (7R2)	J	J	J	S	S	S	T	T	T	T	B, C, D
7.3pF (7R3)	J	J	J	S	S	S	T	T	T	T	B, C, D
7.4pF (7R4)	J	J	J	S	S	S	T	T	T	T	B, C, D
7.5pF (7R5)	J	J	J	S	S	S	T	T	T	T	B, C, D
7.6pF (7R6)	J	J	J	S	S	S	T	T	T	T	B, C, D
7.7pF (7R7)	J	J	J	S	S	S	T	T	T	T	B, C, D
7.8pF (7R8)	J	J	J	S	S	S	T	T	T	T	B, C, D
7.9pF (7R9)	J	J	J	S	S	S	T	T	T	T	B, C, D
8.0pF (8R0)	J	J	J	S	S	S	T	T	T	T	B, C, D
8.1pF (8R1)	J	J	J	S	S	S	T	T	T	T	B, C, D
8.2pF (8R2)	J	J	J	S	S	S	T	T	T	T	B, C, D

**CAPACITANCE RANGE** -NPO (COG) DIELECTRIC - SIZE 0505, 0603, 0805

Table 1-I

SIZE	0505			0603			0805				TOLERANCE
	50	100	250	50	100	250	50	100	250	500	
8.3pF (8R3)	J	J	J	S	S	S	T	T	T	T	B, C, D
8.4pF (8R4)	J	J	J	S	S	S	T	T	T	T	B, C, D
8.5pF (8R5)	J	J	J	S	S	S	T	T	T	T	B, C, D
8.6pF (8R6)	J	J	J	S	S	S	T	T	T	T	B, C, D
8.7pF (8R7)	J	J	J	S	S	S	T	T	T	T	B, C, D
8.8pF (8R8)	J	J	J	S	S	S	T	T	T	T	B, C, D
8.9pF (8R9)	J	J	J	S	S	S	T	T	T	T	B, C, D
9.0pF (9R0)	J	J	J	S	S	S	T	T	T	T	B, C, D
9.1pF (9R1)	J	J	J	S	S	S	T	T	T	T	B, C, D
9.2pF (9R2)	J	J	J	S	S	S	T	T	T	T	B, C, D
9.3pF (9R3)	J	J	J	S	S	S	T	T	T	T	B, C, D
9.4pF (9R4)	J	J	J	S	S	S	T	T	T	T	B, C, D
9.5pF (9R5)	J	J	J	S	S	S	T	T	T	T	B, C, D
9.6pF (9R6)	J	J	J	S	S	S	T	T	T	T	B, C, D
9.7pF (9R7)	J	J	J	S	S	S	T	T	T	T	B, C, D
9.8pF (9R8)	J	J	J	S	S	S	T	T	T	T	B, C, D
9.9pF (9R9)	J	J	J	S	S	S	T	T	T	T	B, C, D
10pF (100)	J	J	J	S	S	S	T	T	T	T	F, G, J
11pF (110)	J	J	J	S	S	S	T	T	T	T	F, G, J
12pF (120)	J	J	J	S	S	S	T	T	T	T	F, G, J
13pF (130)	J	J	J	S	S	S	T	T	T	T	F, G, J
15pF (150)	J	J	J	S	S	S	T	T	T	T	F, G, J
16pF (160)	J	J	J	S	S	S	T	T	T	T	F, G, J
18pF (180)	J	J	J	S	S	S	T	T	T	T	F, G, J
20pF (200)	J	J	J	S	S	S	T	T	T	T	F, G, J
22pF (220)	J	J	J	S	S	S	T	T	T	T	F, G, J
24pF (240)	J	J	J	S	S	S	T	T	T	T	F, G, J
27pF (270)	J	J	J	S	S	S	T	T	T	T	F, G, J
30pF (300)	J	J	J	S	S	S	T	T	T	T	F, G, J
33pF (330)	J	J	J	S	S	S	T	T	T	T	F, G, J
36pF (360)	J	J	J	S	S	S	T	T	T	T	F, G, J
39pF (390)	J	J	J	S	S	S	T	T	T	T	F, G, J
43pF (430)	J	J	J	S	S	S	T	T	T	T	F, G, J
47pF (470)	J	J	J	S	S	S	T	T	T	T	F, G, J



**CAPACITANCE RANGE** -NPO (COG) DIELECTRIC - SIZE 1111

Table 1-K

SIZE	1111					TOLERANCE
	50	100	200	250	500	
2.0pF (2R0)	G	G	G	G	G	A, B, C
2.2pF (2R2)	G	G	G	G	G	A, B, C
2.7pF (2R7)	G	G	G	G	G	A, B, C
3.3pF (3R3)	G	G	G	G	G	A, B, C
3.9pF (3R9)	G	G	G	G	G	A, B, C
4.7pF (4R7)	G	G	G	G	G	A, B, C
5.6pF (5R6)	G	G	G	G	G	B, C, D
6.8pF (6R8)	G	G	G	G	G	B, C, D
8.2pF (8R2)	G	G	G	G	G	B, C, D
10pF (100)	G	G	G	G	G	F, G, J
12pF (120)	G	G	G	G	G	F, G, J
15pF (150)	G	G	G	G	G	F, G, J
18pF (180)	G	G	G	G	G	F, G, J
22pF (220)	G	G	G	G	G	F, G, J
27pF (270)	G	G	G	G	G	F, G, J
33pF (330)	G	G	G	G	G	F, G, J
39pF (390)	G	G	G	G	G	F, G, J
47pF (470)	G	G	G	G	G	F, G, J
56pF (560)	G	G	G	G	G	F, G, J
68pF (680)	G	G	G	G	G	F, G, J
82pF (820)	G	G	G	G	G	F, G, J
100pF (101)	G	G	G	G	G	F, G, J
120pF (121)	G	G	G	G	G	F, G, J
150pF (151)	G	G	G	G	G	F, G, J
180pF (181)	G	G	G	G	G	F, G, J
220pF (221)	G	G	G	G	G	F, G, J
270pF (271)	G	G	G	G	G	F, G, J
330pF (331)	G	G	G	G	G	F, G, J
390pF (391)	G	G	G	G	G	F, G, J
470pF (471)	G	G	G	G	G	F, G, J
560pF (561)	G	G	G	G	G	F, G, J
680pF (681)	G	G	G	G	G	F, G, J
820pF (821)	G	G	G	G	G	F, G, J
1000pF (102)	G	G	G	G	G	F, G, J

**CAPACITANCE RANGE** - ESR VS FREQUENCY SIZE 0201 AND 0402

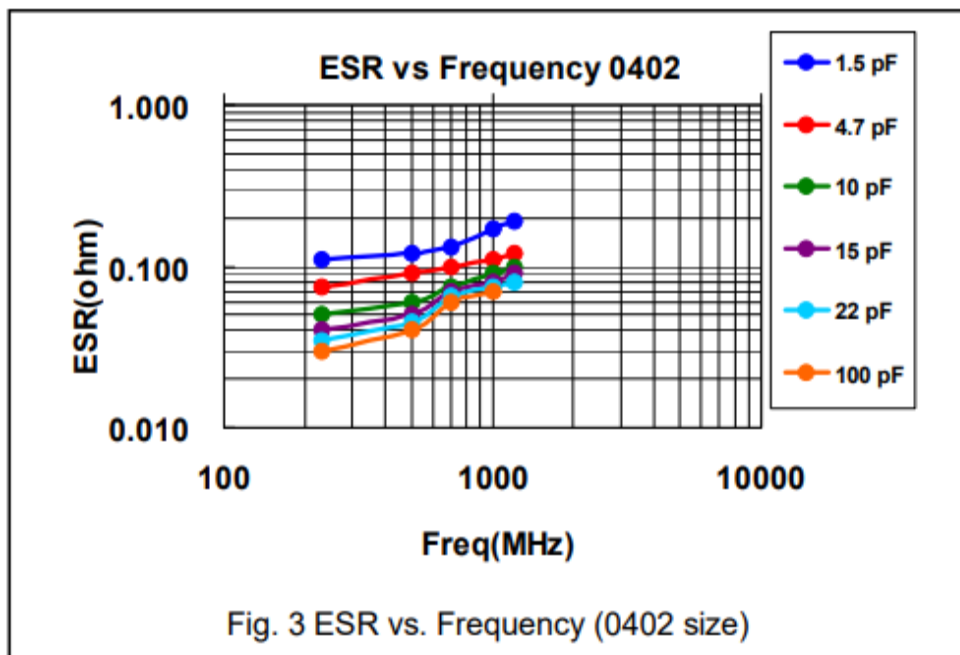
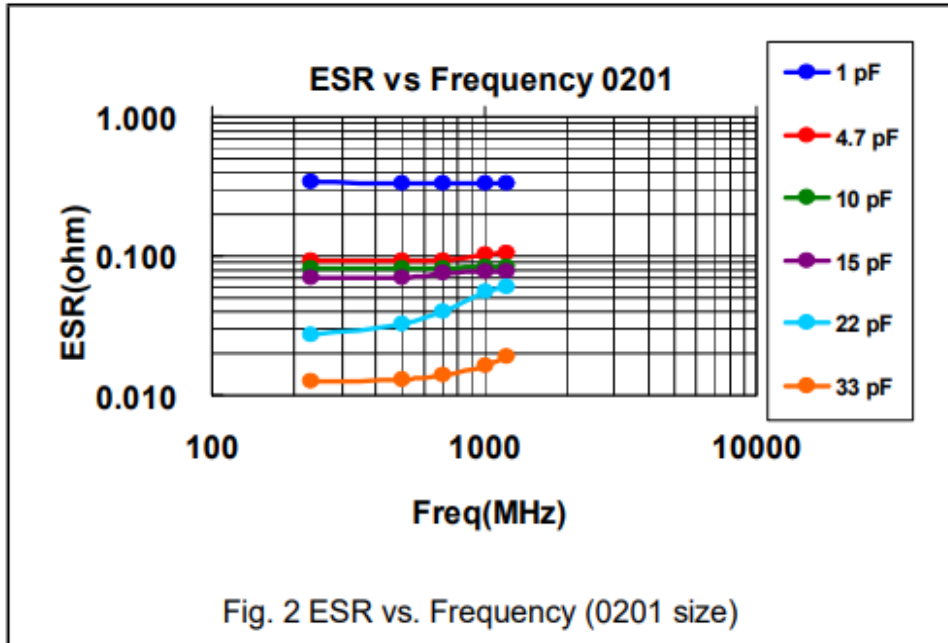

**CAPACITANCE RANGE – Q. VS FREQUENCY SIZE 0201 AND 0402**

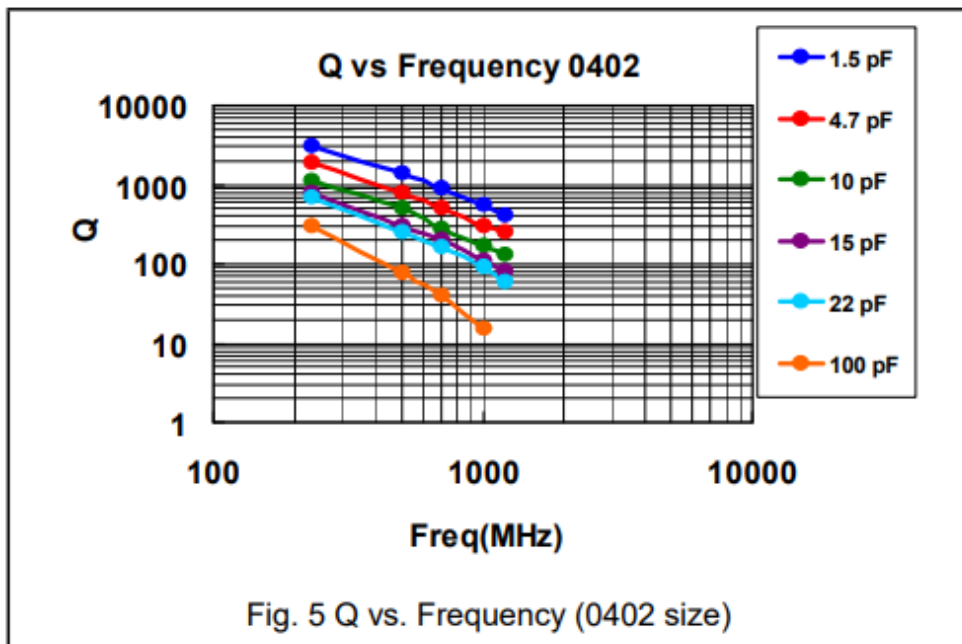
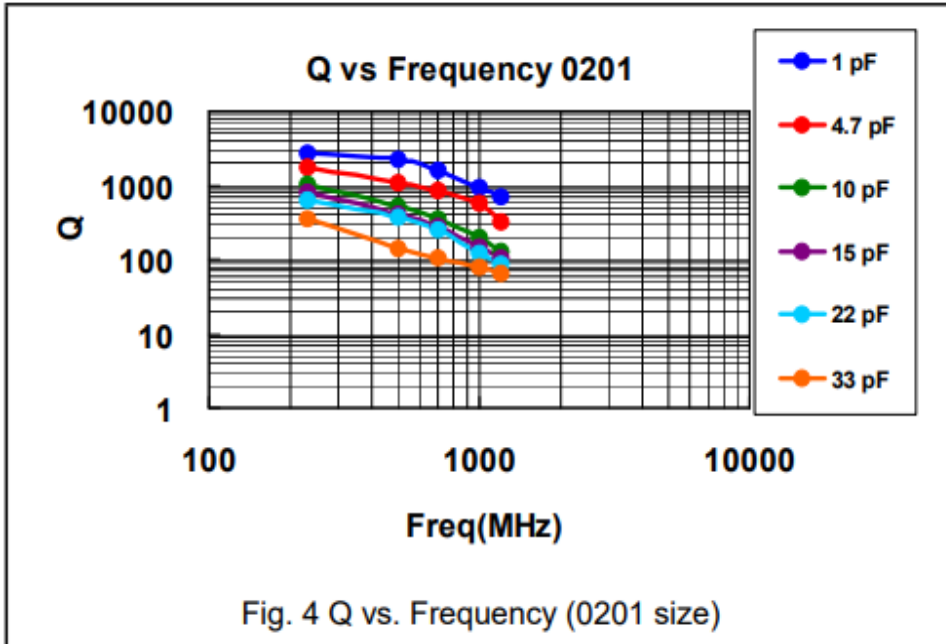

**CAPACITANCE RANGE - IMPEDANCE VS FREQUENCY SIZE 0201 AND 0402**

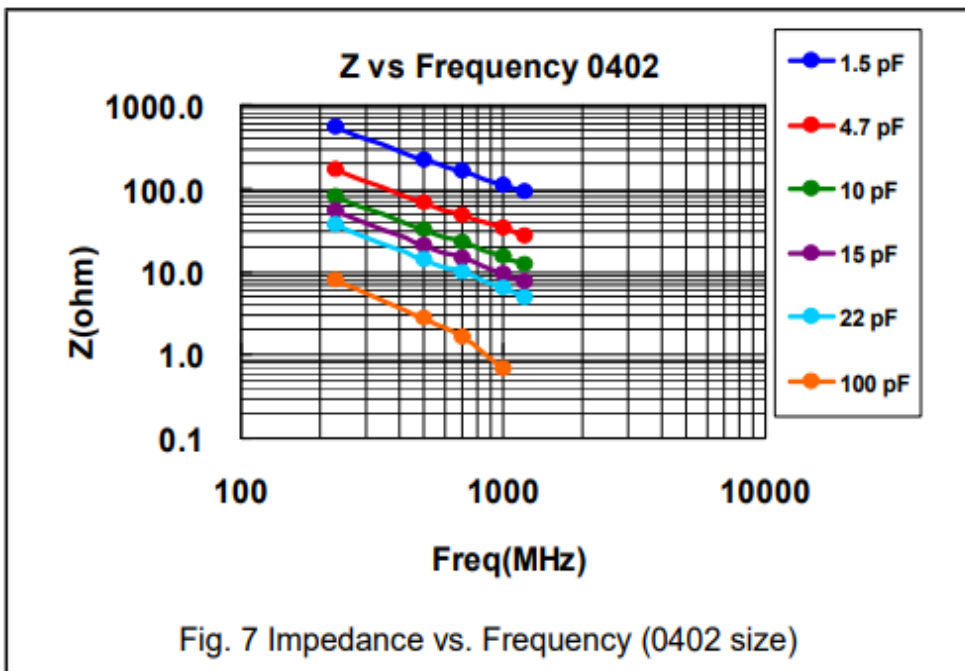
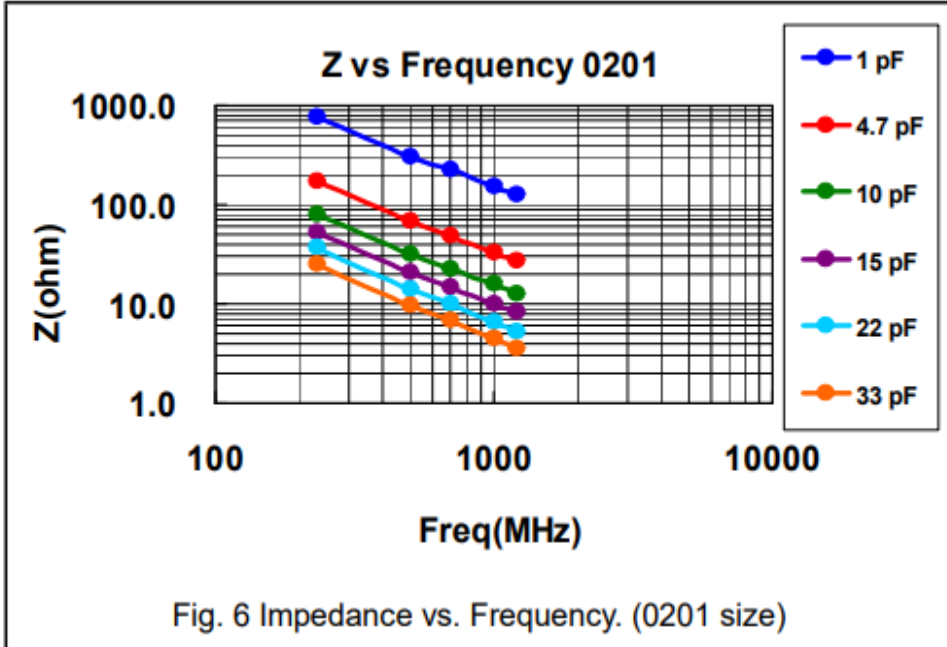

**CAPACITANCE RANGE - ESR VS FREQUENCY SIZE 0603 AND 0805**

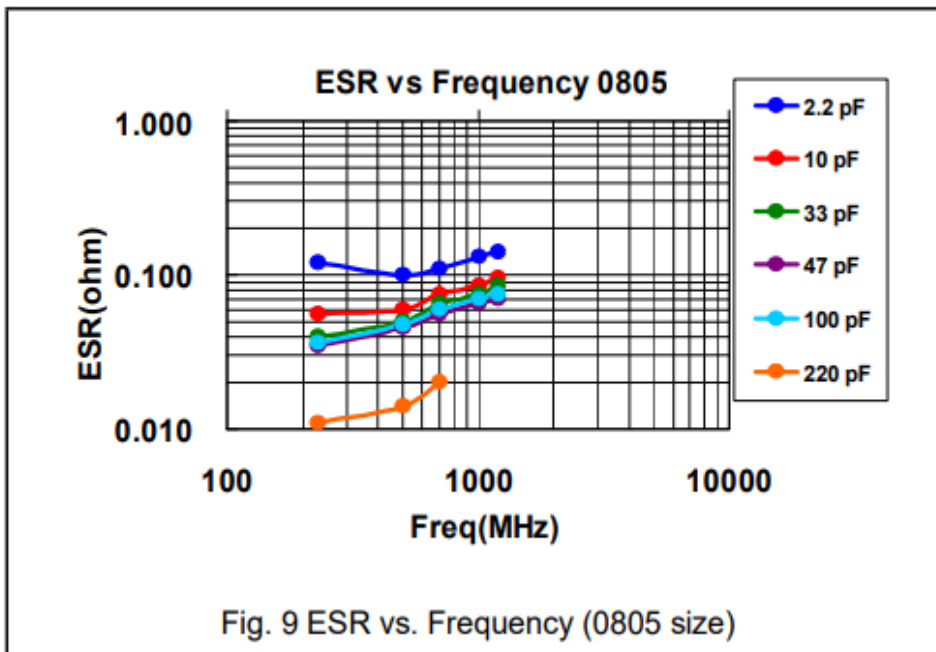
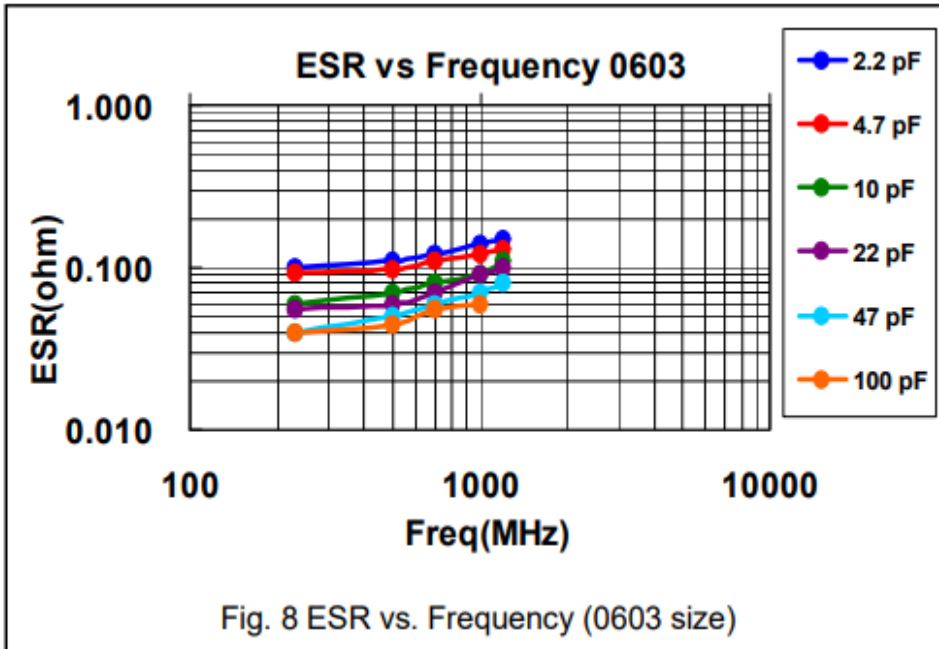



**CAPACITANCE RANGE – Q. VS FREQUENCY SIZE 0603 AND 0805**

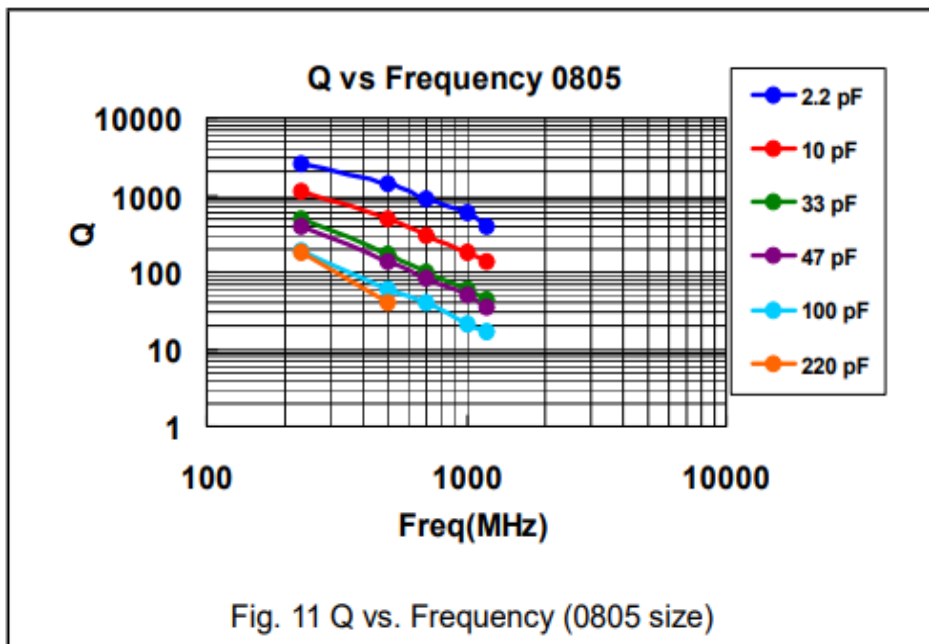
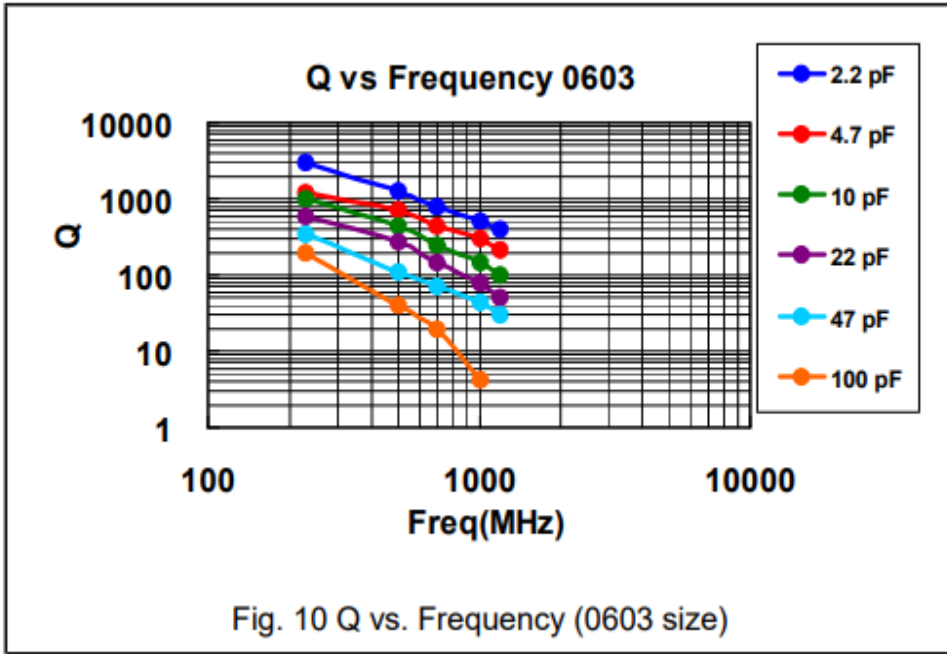

**CAPACITANCE RANGE – IMPEDANCE. VS FREQUENCY SIZE 0603 AND 0805**

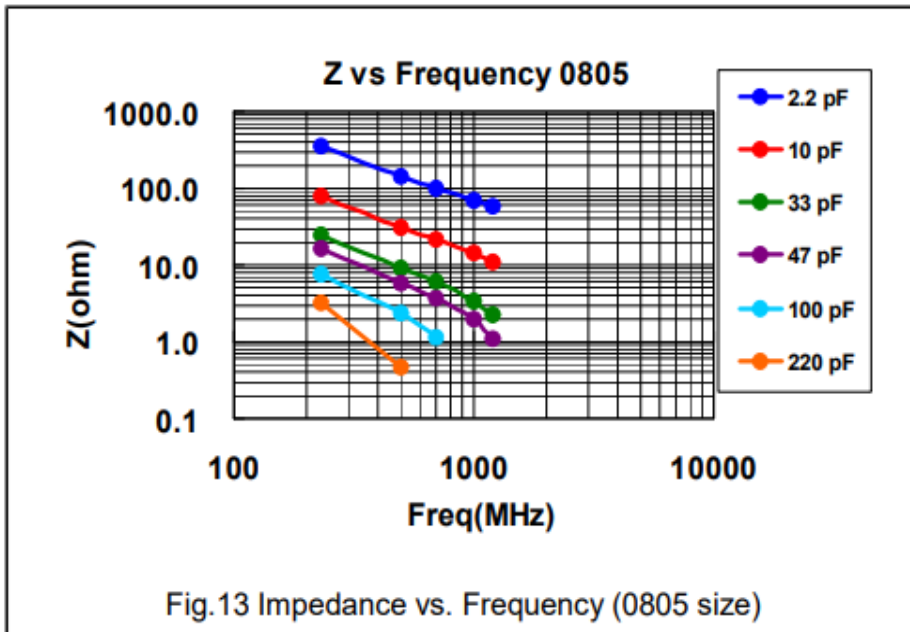
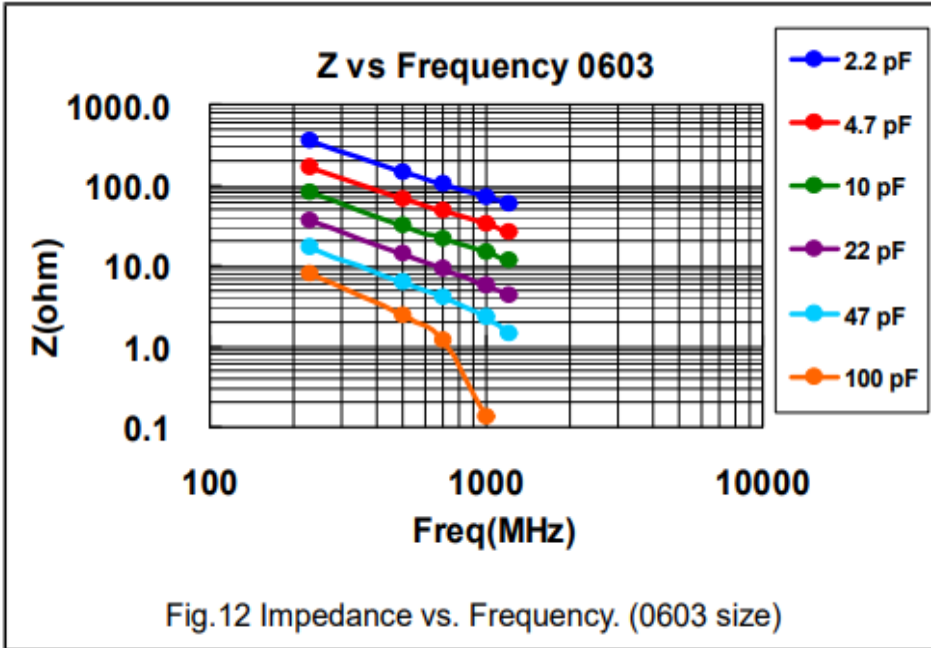

**CAPACITANCE RANGE – ESR. VS FREQUENCY SIZE 0505**

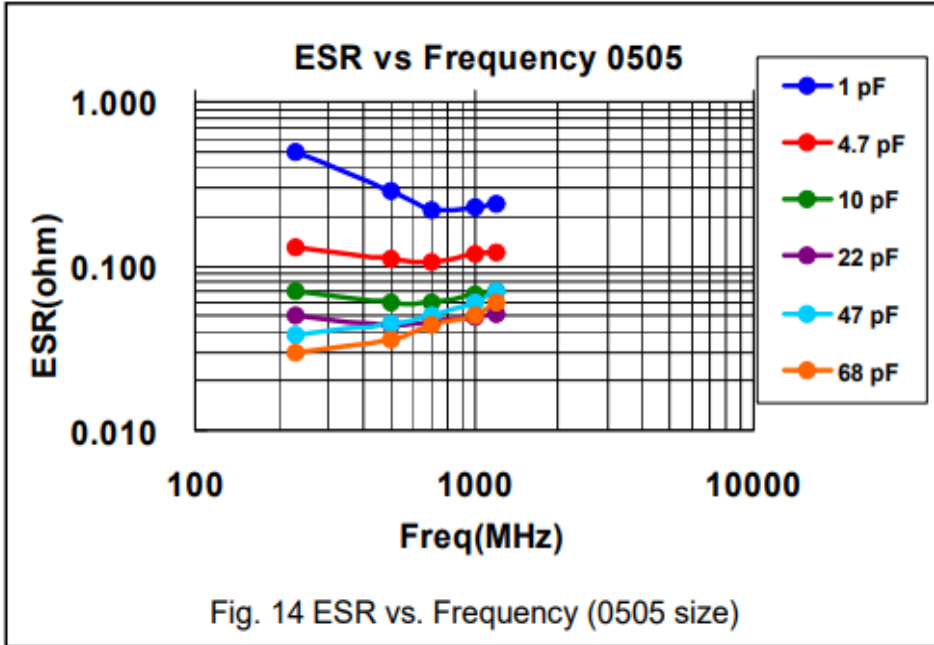

**CAPACITANCE RANGE – Q. VS FREQUENCY SIZE 0505**

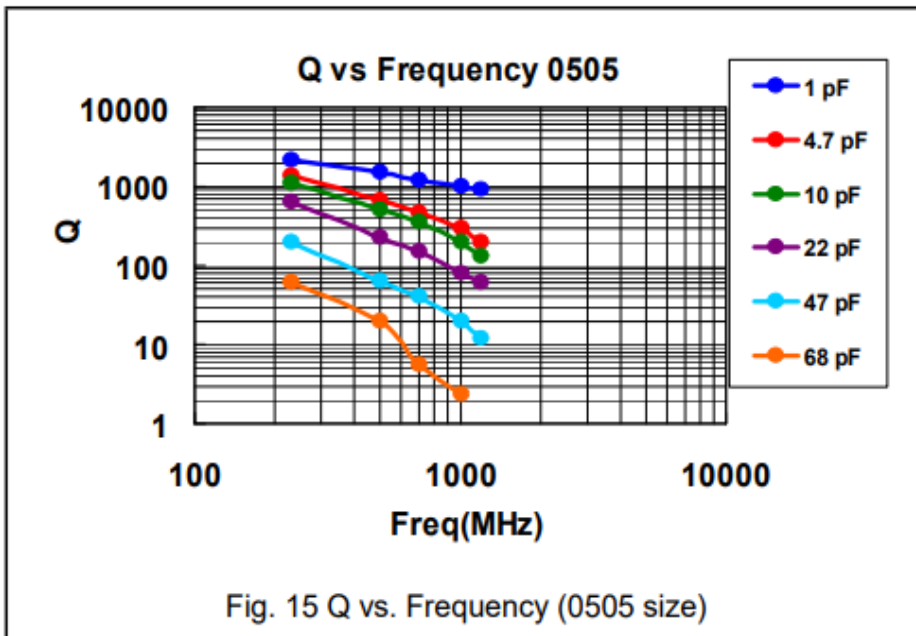

**CAPACITANCE RANGE – IMPEDANCE. VS FREQUENCY SIZE 0505**

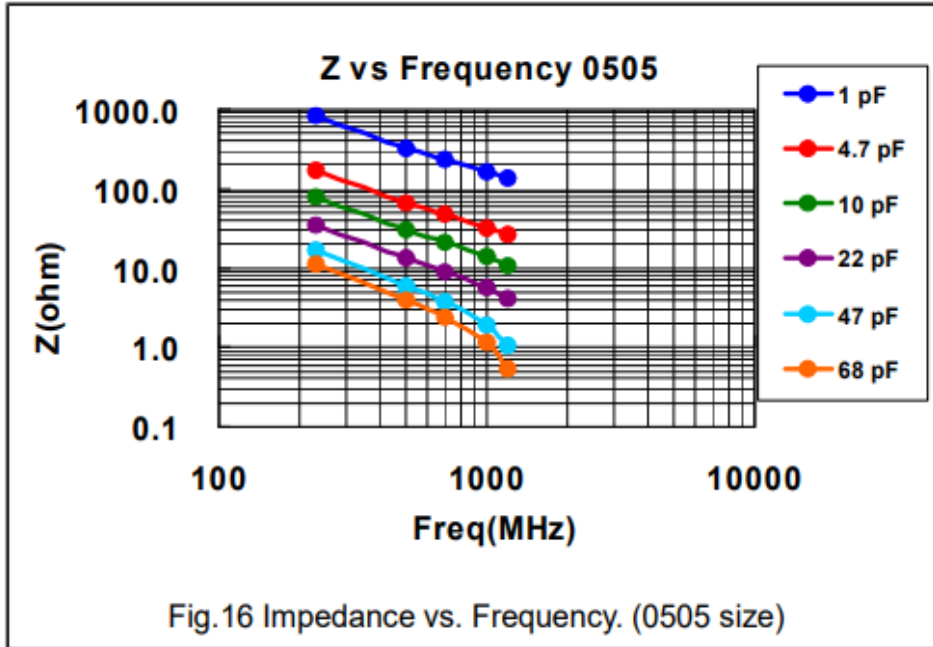

**CAPACITANCE RANGE – SELF RESONANCE FREQUENCY VS CAPACITANCE SIZE 0201/0402/0603/0505/0805**

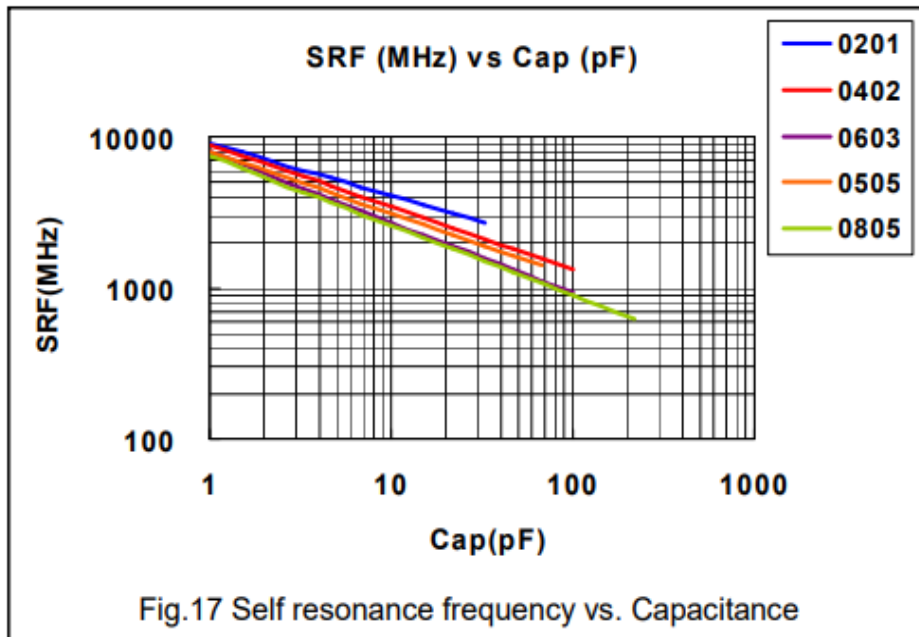

**RELIABILITY TEST CONDITIONS AND REQUIREMENTS**

ITEM	TEST CONDITIONS	REQUIREMENTS
Visual and Mechanical	-----	<ul style="list-style-type: none"> <li>* No remarkable defect.</li> <li>* Dimensions to conform to individual specification sheet.</li> </ul>
Capacitance	<p><math>1.0 \pm 0.2V_{rms}</math>, <math>1MHz \pm 10\%</math> At 25° C ambient temperature.</p>	<ul style="list-style-type: none"> <li>* Shall not exceed the limits given in the detailed spec.</li> </ul>
Q/ D.F. (Dissipation Factor)		<ul style="list-style-type: none"> <li>* 01005, 0201, 0402/25V~50V: Cap&lt;30pF, Q≥400+20C; Cap≥30pF, Q≥1000</li> <li>* 0402/100V~200V, 0603, 0805, 0505, 1111: Cap&lt;30pF: Q≥800+20C; Cap≥30pF: Q≥1400</li> </ul>
Dielectric Strength	<p>*To apply voltage:  <math>\leq 100V</math> : 250% of rated voltage.            200V ~ 300V : 200% of rated voltage.            500V ~ 999V : 150% of rated voltage.            1000V ~ 3000V : 120% of rated voltage.            4000V : 110% of rated voltage.            *Duration: 1 to 5 sec.            *Charge &amp; discharge current less than 50mA.</p>	<ul style="list-style-type: none"> <li>* No evidence of damage or flash over during test.</li> </ul>
Insulation Resistance	<p><math>\leq 100V</math> : To apply rated voltage for max. 120 sec.  <math>\geq 200V</math> :To apply rated voltage (500V max.) for 60 sec.</p>	<p><math>\geq 10G\Omega</math> or <math>RxC \geq 100\Omega \cdot F</math> whichever is smaller</p>
Temperature Coefficient	<p>With no electrical load.            Operating temperature: -55~125° C at 25° C</p>	<ul style="list-style-type: none"> <li>*Capacitance change: within <math>\pm 30ppm/^{\circ} C</math>;            0201Cap≥22pF, within <math>\pm 60ppm/^{\circ} C</math></li> </ul>
Adhesive Strength of Termination	<p>*Pressurizing force:            01005: 1N; 0201: 2N; 0402 to 0603: 5N            &gt;0603: 10N            * Test time: <math>10 \pm 1</math> sec.</p>	<ul style="list-style-type: none"> <li>* No remarkable damage or removal of the terminations.</li> </ul>

**RELIABILITY TEST CONDITIONS AND REQUIREMENTS**

ITEM	TEST CONDITIONS	REQUIREMENTS
Vibration Resistance	<ul style="list-style-type: none"> <li>* Vibration frequency: 10~55 Hz/min.</li> <li>* Total amplitude: 1.5mm</li> <li>* Test time: 6 hrs. (Two hrs each in three mutually perpendicular directions.)</li> <li>*Cap./DF(Q) Measurement to be made after de-aging at 150° C for 1hr then set for 24±2 hrs at room temp.</li> </ul>	<ul style="list-style-type: none"> <li>*No remarkable damage.</li> <li>* Cap change and Q/D.F.: To meet initial spec.</li> </ul>
Solderability	<ul style="list-style-type: none"> <li>* Solder temperature: 235 ± 5° C</li> <li>* Dipping time: 2 ± 0.5 sec.</li> </ul>	95% min. coverage of all metalized area.
Bending Test	<ul style="list-style-type: none"> <li>*The middle part of substrate shall be pressurized by means of the pressurizing rod at a rate of about 1 mm per second until the deflection becomes 1 mm and then the pressure shall be maintained for 5 ± 1 sec.</li> <li>* Measurement to be made after keeping at room temp. for 24 ± 2 hrs.</li> </ul>	<ul style="list-style-type: none"> <li>*No remarkable damage.</li> <li>* Cap change: within ± 5.0% or ± 0.5pF whichever is larger. (This capacitance change means the change of capacitance under specified flexure of substrate from the capacitance measured before the test.)</li> </ul>
Resistance to Soldering Heat	<ul style="list-style-type: none"> <li>* Solder temperature: 260 ± 5° C</li> <li>* Dipping time: 10 ± 1 sec</li> <li>*Preheating: 120 to 150° C for 1 minute before immerse the capacitor in a eutectic solder.</li> <li>*Cap. / DF(Q) / I.R. Measurement to be made after de-aging at 150° C for 1hr then set for 24 ± 2 hrs at room temp.</li> </ul>	<ul style="list-style-type: none"> <li>* No remarkable damage.</li> <li>*Cap change: within ± 2.5% or ± 0.25pF whichever is larger.</li> <li>* Q/D.F., I.R. and dielectric strength: To meet initial requirements.</li> <li>* 25% max. leaching on each edge.</li> </ul>
Temperature Cycle	<ul style="list-style-type: none"> <li>*Conduct the five cycles according to the temperatures and time <i>See &lt;Table 2&gt;</i></li> <li>* Cap. / DF(Q) / I.R. Measurement to be made after de-aging at 150° C for 1hr then set for 24 ± 2 hrs at room temp.</li> </ul>	<ul style="list-style-type: none"> <li>* No remarkable damage.</li> <li>* Cap change: within ± 2.5% or ± 0.25pF whichever is larger.</li> <li>* Q/D.F., I.R. and dielectric strength: To meet initial requirements.</li> </ul>

**RELIABILITY TEST CONDITIONS AND REQUIREMENTS**

ITEM	TEST CONDITIONS	REQUIREMENTS
Humidity (Damp Heat) Steady State	<ul style="list-style-type: none"> <li>*Test temp.: <math>40 \pm 2^{\circ}</math> C</li> <li>* Humidity: 90~95% RH</li> <li>* Test time: 500+24/-0hrs.</li> <li>* Cap. / DF(Q) / I.R. Measurement to be made after de-aging at <math>150^{\circ}</math> C for 1hr then set for <math>24 \pm 2</math> hrs at room temp.</li> </ul>	<ul style="list-style-type: none"> <li>* No remarkable damage.</li> <li>* Cap change: within <math>\pm 5.0\%</math> or <math>\pm 0.5\text{pF}</math> whichever is larger.</li> <li>*Q/D.F. value: Cap<math>\geq 30\text{pF}</math>, Q<math>\geq 350</math>; 10pF<math>\leq</math>Cap<math>&lt; 30\text{pF}</math>, Q<math>\geq 275+2.5\text{C}</math> Cap<math>&lt; 10\text{pF}</math>, Q<math>\geq 200+10\text{C}</math></li> <li>* I.R.: <math>\geq 1\text{G}\Omega</math>.</li> </ul>
Humidity (Damp Heat) Load	<ul style="list-style-type: none"> <li>*Test temp.: <math>40 \pm 2^{\circ}</math> C</li> <li>* Humidity: 90~95%RH</li> <li>* Test time: 500+24/-0 hrs.</li> <li>*To apply voltage: rated voltage (MAX. 500V)</li> <li>* Cap. / DF(Q) / I.R. Measurement to be made after de-aging at <math>150^{\circ}</math> C for 1hr then set for <math>24 \pm 2</math> hrs at room temp.</li> </ul>	<ul style="list-style-type: none"> <li>* No remarkable damage.</li> <li>* Cap change: within <math>\pm 7.5\%</math> or <math>\pm 0.75\text{pF}</math> whichever is larger.</li> <li>*Q/D.F. value: Cap<math>\geq 30\text{pF}</math>, Q<math>\geq 200</math>; Cap<math>&lt; 30\text{pF}</math>, Cap<math>\geq 100+10/3\text{C}</math></li> <li>* I.R.: <math>\geq 500\text{M}\Omega</math>.</li> </ul>
High Temperature Load (Endurance)	<ul style="list-style-type: none"> <li>* Test temp.: <math>125 \pm 3^{\circ}</math> C</li> <li>* To apply voltage:               <ul style="list-style-type: none"> <li>(1) <math>10\text{V} \leq \text{Ur} &lt; 500\text{V}</math>: 200% of rated voltage.</li> <li>(2) <math>\leq 6.3\text{V}</math> or 500V: 150% of rated voltage.</li> <li>(3) <math>\text{Ur} \geq 630\text{V}</math>: 120% of rated voltage.</li> </ul> </li> <li>* Test time: 1000+24/-0 hrs.</li> <li>* Cap. / DF(Q) / I.R. Measurement to be made after de-aging at <math>150^{\circ}</math> C for 1hr then set for <math>24 \pm 2</math> hrs at room temp</li> </ul>	<ul style="list-style-type: none"> <li>* No remarkable damage.</li> <li>* Cap change: within <math>\pm 3.0\%</math> or <math>\pm 0.3\text{pF}</math> whichever is larger.</li> <li>* Q/D.F. value: Cap<math>\geq 30\text{pF}</math>, Q<math>\geq 350</math> 10pF<math>\leq</math>Cap<math>&lt; 30\text{pF}</math>, Q<math>\geq 275+2.5\text{C}</math> Cap<math>&lt; 10\text{pF}</math>, Q<math>\geq 200+10\text{C}</math></li> <li>* I.R.: <math>\geq 1\text{G}\Omega</math>.</li> </ul>
ESR	The ESR should be measured at room temperature and tested at frequency $1 \pm 0.1$ GHz.	See <Table 3>
	The ESR should be measured at room temperature and tested at frequency $500 \pm 50$ MHz	0201, 22pF $\leq$ Cap $\leq 33\text{pF}$ : $< 300\text{m}\Omega$

**TEMPERATURE CYCLE – TEST CONDITION**

Table 2

Step	Temp. (°C)	Time (min.)
1	Min. operating temp. +0/-3	30±3
2	Room temp.	2~3
3	Max. operating temp. +3/-0	30±3
4	Room temp.	2~3

**ESR – REQUIREMENTS**

Table 3

01005	0505
0.2pF≤Cap≤1pF:< 700mΩ/pF	0.4pF≤Cap<1.0pF: < 1500mΩ
1pF<Cap≤2pF:< 600mΩ	1.0pF≤Cap<10pF:< 250mΩ
2pF<Cap≤5pF:< 500mΩ	10pF≤Cap≤100pF: < 200mΩ
5pF<Cap≤10pF:< 300mΩ	
10pF<Cap≤22pF:< 350mΩ	

0201	0402
0.1pF≤Cap≤1pF:< 350mΩ/Pf	0.1pF≤Cap≤1pF:< 350mΩ/pF
1pF<Cap≤5pF:< 300mΩ	1pF<Cap≤5pF:< 300mΩ
5pF<Cap≤22pF:< 250mΩ	5pF<Cap≤100pF:< 250mΩ
22pF≤Cap≤33pF: < 300mΩ	

0603	0805
0.3pF≤Cap≤1pF:< 1500mΩ	0.3pF≤Cap≤1pF: < 1500mΩ
1pF<Cap≤10pF:< 250mΩ	1pF<Cap≤10pF: < 250mΩ
10pF<Cap≤100pF:< 200mΩ	Cap>10pF: < 200mΩ



### RECOMMENDED PROFILE CONDITIONS

The lead-free termination MLCCs are not only to be used on SMT against lead-free solder paste, but also suitable against lead-containing solder paste.

If the optimized solder joint is requested, increasing soldering time, temperature and concentration of N2 within oven are recommended.

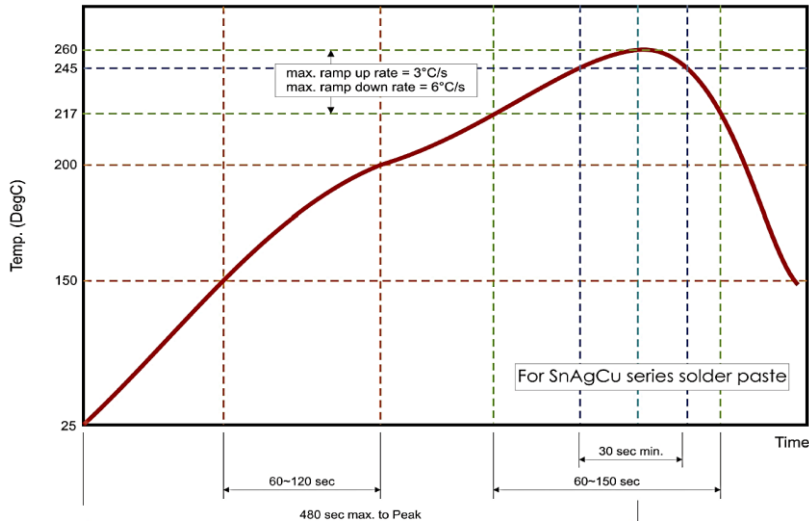

Reflow Soldering Profile For SMT Process with SnAgCu series Solder Paste

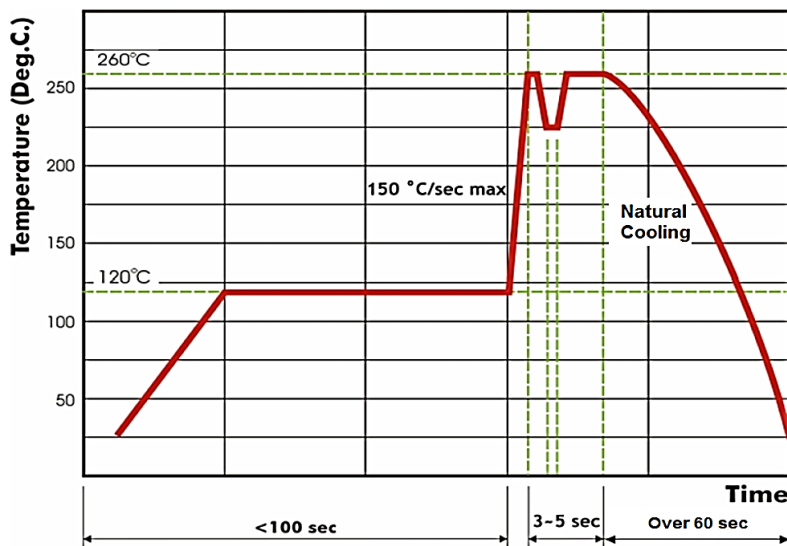

Wave Soldering Profile For SMT Process with SnAgCu series Solder Paste

## STORAGE AND HANDLING CONDITIONS

- To store products at 5 to 40°C ambient temperature and 20 to 70% related humidity conditions.
- The product is recommended to be used within one year after shipment. Check solder ability in case of shelf life extension is needed.
- Don't open the tape until the parts are to be used, use the chips within 3 months after the tape is opened.
- For product of high dielectric constant (Class2&3, characteristics B/W & Y), the Electro static capacity changes with the passage of time due to the inherent characteristics of ceramic dielectric materials. The changed capacity reverts to nominal at the temperature it reaches during the soldering process.

## CAUTIONS

- The corrosive gas reacts on the terminal electrodes of capacitors, and results in the poor solder ability. Do not store the capacitors in the ambience of corrosive gas (e.g., hydrogen sulfide, sulfur dioxide, chlorine, ammonia gas etc.)
- In corrosive atmosphere, solder ability might be degraded, and silver migration might occur to cause low reliability.
- Due to the dewing by rapid humidity change, or the photochemical change of the terminal electrode by direct sun light, the solder ability and electrical performance may deteriorate. Do not store capacitors under direct sunlight or dewing condition. To store products on the shelf and avoid exposure to moisture.

**TAPE DIMENSION** (Unit: mm)

Paper Tape

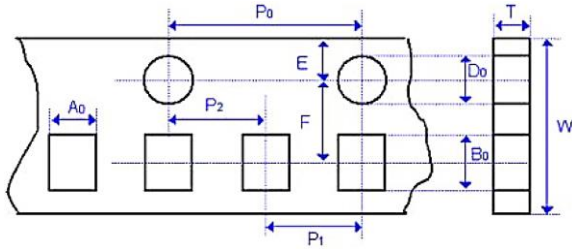

Plastic Tape

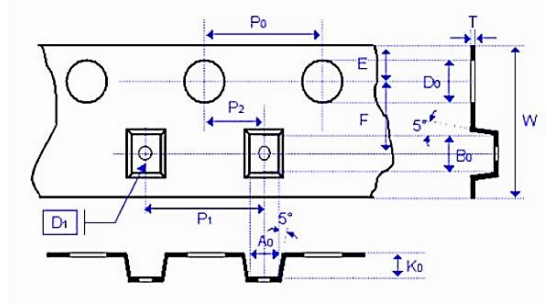

SIZE	01005	0201	0402	0505	0603	0805	1111
Thickness	V	L	N	J	S	T	G
A0	0.25 +/-0.05	0.40 +/-0.07	0.70 +/-0.2	<1.90	1.05 +/-0.30	1.50 +/-0.20	< 3.05
B0	0.45 +/-0.05	0.70 +/-0.07	1.20 +/-0.2	<1.90	1.80 +/-0.30	2.30 +/-0.20	< 3.80
T	≤0.50	≤0.55	≤0.80	0.23 ± 0.10	≤1.20	≤1.20	0.23 +/-0.1
K0	-	-	-	<1.50	-	-	< 2.50
W	8.00 +/-0.10	8.00 +/-0.10	8.00 +/-0.10	8.00 +/-0.20	8.00 +/-0.10	8.00 +/-0.10	8.00 +/-0.20
P0	4.00 +/-0.10	4.00 +/-0.10	4.00 +/-0.10	4.00 +/-0.10	4.00 +/-0.10	4.00 +/-0.10	4.00 +/-0.10
10xP0	40.00 +/-0.10	40.00 +/-0.10	40.00 +/-0.10	40.00 +/-0.20	40.00 +/-0.20	40.00 +/-0.20	40.00 +/-0.20
P1	2.00 +/-0.05	2.00 +/-0.05	2.00 +/-0.05	4.00 +/-0.10	4.00 +/-0.10	4.00 +/-0.10	4.00 +/-0.10
P2	2.00 +/-0.05	2.00 +/-0.05	2.00 +/-0.05	2.00 +/-0.05	2.00 +/-0.05	2.00 +/-0.05	2.00 +/-0.05
D0	1.55 +/-0.05	1.55 +/-0.05	1.55 +/-0.05	1.55 +/-0.05	1.55 +/-0.05	1.55 +/-0.05	1.55 +1/-0
D1	-	-	-	1.00 ± 0.10	-	-	1.00 ± 0.10
E	1.75 +/-0.05	1.75 +/-0.05	1.75 +/-0.05	1.75 +/-0.05	1.75 +/-0.05	1.75 +/-0.05	1.75 +/-0.10
F	3.50 +/-0.05	3.50 +/-0.05	3.50 +/-0.05	3.50 +/-0.05	3.50 +/-0.05	3.50 +/-0.05	3.50 +/-0.05

**REEL DIMENSION** (Unit: mm)

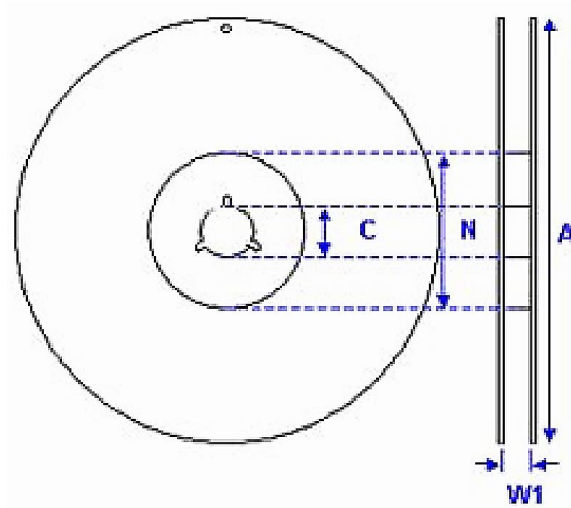

Size Code	01005, 0201, 0402, 0505, 0603, 0805, 1111	
Reel Size	7"	13"
C	13.0+0.5/-0.2	13.0+0.5/-0.2
W 1	8.4+1.5/0	8.4+1.5/-0
A	178.0±0.10	330.0±1.0
N	60.0+1.0/-0	100±1.0

## IMPORTANT NOTES AND DISCLAIMER

1. **ROHS COMPLIANCE:** The levels of RoHS restricted materials in this product are below the maximum concentration values (also referred to as the threshold limits) permitted for such substances, or are used in an exempted application, in accordance with EU RoHS Directive (EU) 2015/863 EC (RoHS3). RoHS Test Report for this product can be obtained at Download Center.
2. **REACH COMPLIANCE:** REACH substances of high concern (SVHCs) information is available for this product. Since the European Chemical Agency (ECHA) has published notice of their intent to frequently revise the SVHC listing for the foreseeable future, REACH Test Report for this product can be obtained at Download Center.
3. All Product parametric performance is indicated in the Electrical Characteristics for the listed herein test conditions, unless otherwise noted. Product performance may not be indicated by the Electrical Characteristics if operated under different conditions.
4. NextGen Component, Inc (*NextGen*) reserves the right to make changes to this document and its products and specifications at any time without notice. Customers should obtain and confirm the latest product information and specifications before final design, purchase or use.
5. *NextGen* makes no warranty, representation or guarantee regarding the suitability of its products for any particular purpose, not does *NextGen* assume any liability for application assistance or customer product design.
6. *NextGen* does not warrant or accept any liability with products which are purchased or used for any unintended or unauthorized application. No license is granted by implication or otherwise under any intellectual property rights of NextGen.
7. *NextGen* products are not authorized for use as critical components in life support devices or systems without express written approval by *NextGen*.
8. *NextGen* requires that customers first obtain an RMA (Returned Merchandise Authorization) number prior to returning any products. Returns must be made within 30 days of the date of invoice, be in the original packaging, unused and like-new condition. At the time of quoting or purchasing, a product may say that it is Non-Cancelable/ Non-Returnable (NCNR). These products are not returnable and not refundable.