



| | | |
|-----------------------------------------|-------------------------------------------------------------------------------------------------------------------------------------------------------------------------------------------------------------------------------------------------------------------------------------------------------------------------------------------------------------------------------------------------------------------------------------|--------------------------------------------------|
| SPECIFICATION SHEET NO. | R1203- 1206N471J102GB | |
| ORIGINAL MFG/PART NO. | Aillen Capacitors/1206N471J102GB-G | |
| NEXTGEN PART CODE | 1206N471J102GB | Indicate This Code For RFQ/Order |
| DATE | Dec. 3, 2024 | |
| REVISION | A7 | Updated With Most Recent Data |
| DESCRIPTION AND MAIN PARAMETRICS | <p>High Voltage Multilayer Ceramic Chip Capacitors (MLCC), G Type, 1206 Series Case 3216 Metric 1206, Dimension L3.20*W1.60*H1.60mm Thickness: 1.80mm Max. Dielectric NPO, Capacitance 470pF, Tolerance ±5% Rated Voltage 1000V Operating Temp. Range -55°C ~+125°C Package in Tape/Reel, 2,000pcs/Reel REACH/RoHS/RoHS III Compliant</p> | |
| CUSTOMER | | |
| CUSTOMER PART NUMBER | | |
| CROSS REF. PART NUMBER | | |
| MEMO | | |

| | | |
|------------------------------|---------------------------------------------------------------------------------------|--------------------------------------------------------------------------------------|
| VENDOR APPROVE | | |
| Issued/Checked/Approved |  |  |
| |  | |
| Effective Date: Dec. 3, 2024 | | |

| |
|-------------------------|
| CUSTOMER APPROVE |
| |
| Date: |

DESCRIPTION

High voltage series MLCC is designed by a special internal electrode pattern, which can reduce voltage concentrations by distributing voltage gradients throughout the entire capacitor. This special design also affords increased capacitance values in a given case size and voltage rate. Capacitors with X7R dielectrics are not intended for AC line filtering applications. Capacitors may require protective surface coating to prevent external arcing.



Image shown is a representation only.

Exact specifications should be obtained from the product dimension.

MAIN FEATURE

- A Wide Selection Of Size Is Available
- High Capacitance and High Voltage 1000V~4000V
- High Reliability And Stability
- Temperature Characteristics: NPO (COG) and X7R
- Capacitor With Lead-free Termination
- REACH/RoHS/RoHS III Compliant



APPLICATION

- Snubbers In High Frequency Power Converters.
- High Voltage Coupling/DC Blocking.
- DC-DC Converters.
- Back-lighting Inverters

ELECTRICAL CHARACTERISTICS

- See Page 4 ~Page 7 For Different Part Code And Rated Voltage.
- All Products Parameters are Subject To NextGen Components' Final Confirmation.

HOW TO ORDER

- Please Follow Up Part Code Guide And Indicate NextGen Part Code 1206N471J102GB For RFQ and Order.

RFQ

[Request For Quotation](#)

PART CODE GUIDE

| CODE | NAME | KEY SPECIFICATION OPTION |
|------|-------------------------|----------------------------------------------------------------------------------------------------------------------------------------------------------------------------------------------------------------------------------------------------------------------------------------------|
| 1206 | Case Size | 0805 (2012 Metric): L2.00*W1.25mm; 1206 (3216 Metric): L3.20*W1.60mm 1210 (3225 Metric): L3.20*W2.50mm; 1808 (4520 Metric): L4.50*W2.03mm 1812 (4532 Metric): L4.50*W3.20mm; 1825 (4563 Metric):L4.50*W6.30mm 2220 (5750 Metric): L5.70*W5.00mm; 2225 (5763 Metric): L5.70*W6.30mm |
| N | Temperature Coefficient | N: NPO (COG); B: X7R |
| 471 | Capacitance | Two significant digits followed by number of Zero, The 3rd digit signifies the multiplying factor, and letter R is decimal point. 0R5: 0.5pF; 471: 470pF; 332: 3300pF; 102: 1000pF; 821: 820pF; 103: 0.01μF |
| J | Tolerance | B: ±0.1pF; C: ±0.25pF; D: ±0.5pF; F: ±1%; G: ±2%; J: ±5%; K: ±10% M: ±20% |
| 102 | Rated Voltage | 102: 1000 VDC; 152: 1500 VDC; 202: 2000 VDC; 252: 2500 VDC 302: 3000 VDC; 402: 4000 VDC |
| G | Thickness | G: 1.60 ±0.20mm, See Page 8 ~ Page 9 (T's Symbol) for Different part code |
| B | Package | K: 0.5 Kpcs/Reel; A: 1Kpcs/Reel; B: 2Kpcs/Reel; C: 3Kpcs/Reel; D: 4Kpcs/Reel; E: 15Kpcs/Reel; I: 10Kpcs/Reel; J: 2.5Kpcs/Reel |
| () | Internal Control | Blank: N/A; XX: Letter A~Z, a~z or digits (0~9) for Special/Custom Parameters |

ELECTRICAL CHARACTERISTICS - 1000V NP0 (COG) & X7R FOR DIFFERENT PART CODE

| NEXTGEN PART CODE | TEMP. COEFFICIENT | CAPACITANCE | TOLERANCE | VOLTAGE | THICKNESS (MAX.) | OPERATING TEMP. RANGE | CAPACITANCE CHARACTERISTIC |
|----------------------|----------------------|-------------|-----------|---------|---------------------|--------------------------|-------------------------------|
| | - | - | - | V | mm | °C | - |
| 0805B102K102BD | X7R | 1000 pF | ±10% | 1000 | 0.90 | -55 ~ 125 | ±15% |
| 1206B102K102DC | X7R | 1000 pF | ±10% | 1000 | 1.35 | -55 ~ 125 | ±15% |
| 1206B103K102DC | X7R | 0.01 µF | ±10% | 1000 | 1.35 | -55 ~ 125 | ±15% |
| 1206B151K102DC | X7R | 150 pF | ±10% | 1000 | 1.35 | -55 ~ 125 | ±15% |
| 1206B152K102DC | X7R | 1500pF | ±10% | 1000 | 1.35 | -55 ~ 125 | ±15% |
| 1206B221K102BD | X7R | 220 pF | ±10% | 1000 | 0.90 | -55 ~ 125 | ±15% |
| 1206B222K102DC | X7R | 2200 pF | ±10% | 1000 | 1.35 | -55 ~ 125 | ±15% |
| 1206B331K102DC | X7R | 330 pF | ±10% | 1000 | 1.35 | -55 ~ 125 | ±15% |
| 1206B332K102DC | X7R | 3300 pF | ±10% | 1000 | 1.35 | -55 ~ 125 | ±15% |
| 1206B471K102DC | X7R | 470 pF | ±10% | 1000 | 1.35 | -55 ~ 125 | ±15% |
| 1206B681K102DC | X7R | 680 pF | ±10% | 1000 | 1.35 | -55 ~ 125 | ±15% |
| 1206B682K102DC | X7R | 6800 pF | ±10% | 1000 | 1.35 | -55 ~ 125 | ±15% |
| 1206B821K102DC | X7R | 820 pF | ±10% | 1000 | 1.35 | -55 ~ 125 | ±15% |
| 1812B103K102DA | X7R | 0.01 µF | ±10% | 1000 | 1.35 | -55 ~ 125 | ±15% |
| 0805N330J102DC | NP0 (COG) | 33 pF | ±5% | 1000 | 1.35 | -55 ~ 125 | ±30ppm |
| 1206N100J102CC | NP0 (COG) | 10 pF | ±5% | 1000 | 1.05 | -55 ~ 125 | ±30ppm |
| 1206N101J102BD | NP0 (COG) | 100 pF | ±5% | 1000 | 0.90 | -55 ~ 125 | ±30ppm |
| 1206N151J102DC | NP0 (COG) | 150 pF | ±5% | 1000 | 1.35 | -55 ~ 125 | ±30ppm |
| 1206N220J102BD | NP0 (COG) | 22 pF | ±5% | 1000 | 0.90 | -55 ~ 125 | ±30ppm |
| 1206N221J102DC | NP0 (COG) | 220 pF | ±5% | 1000 | 1.35 | -55 ~ 125 | ±30ppm |

ELECTRICAL CHARACTERISTICS - 1000V NP0 (COG) & X7R FOR DIFFERENT PART CODE

| NEXTGEN PART CODE | TEMP. COEFFICIENT | CAPACITANCE | TOLERANCE | VOLTAGE | THICKNESS (MAX.) | OPERATING TEMP. RANGE | CAPACITANCE CHARACTERISTIC |
|--------------------------------|----------------------|-------------|-----------|---------|---------------------|--------------------------|-------------------------------|
| | - | - | - | V | mm | °C | - |
| 1206N221J102GB | NP0 (COG) | 220 pF | ±5% | 1000 | 1.80 | -55 ~ 125 | ±30ppm |
| 1206N330J102BD | NP0 (COG) | 33 pF | ±5% | 1000 | 0.90 | -55 ~ 125 | ±30ppm |
| 1206N331J102GB | NP0 (COG) | 330 pF | ±5% | 1000 | 1.80 | -55 ~ 125 | ±30ppm |
| 1206N470J102BC | NP0 (COG) | 47 pF | ±5% | 1000 | 0.90 | -55 ~ 125 | ±30ppm |
| 1206N470J102CC | NP0 (COG) | 47 pF | ±5% | 1000 | 1.05 | -55 ~ 125 | ±30ppm |
| 1206N471J102GB | NP0 (COG) | 470 pF | ±5% | 1000 | 1.80 | -55 ~ 125 | ±30ppm |
| 1206N560J102CC | NP0 (COG) | 56 pF | ±5% | 1000 | 1.05 | -55 ~ 125 | ±30ppm |
| 1206N5R0C102BD | NP0 (COG) | 5 pF | ±0.25pF | 1000 | 0.90 | -55 ~ 125 | ±30ppm |
| 1206N680J102CC | NP0 (COG) | 68 pF | ±5% | 1000 | 1.05 | -55 ~ 125 | ±30ppm |
| 1206N681J102GB | NP0 (COG) | 680 pF | ±5% | 1000 | 1.80 | -55 ~ 125 | ±30ppm |
| 1210B103K102GB | X7R | 0.01 μF | ±10% | 1000 | 1.80 | -55 ~ 125 | ±15% |
| 1808N102J102KA | NP0 (COG) | 1000 pF | ±5% | 1000 | 2.20 | -55 ~ 125 | ±30ppm |
| 1812B104K102MK | X7R | 0.1 μF | ±10% | 1000 | 2.80 | -55 ~ 125 | ±15% |
| 1812B222K102DA | X7R | 2200 pF | ±10% | 1000 | 1.35 | -55 ~ 125 | ±15% |
| 1812B102K102DA | X7R | 1000 pF | ±10% | 1000 | 1.35 | -55 ~ 125 | ±15% |
| 1812N471J102KA | NP0 (COG) | 470 pF | ±5% | 1000 | 2.20 | -55 ~ 125 | ±30ppm |
| 1812N471K102KA | NP0 (COG) | 470 pF | ±10% | 1000 | 2.20 | -55 ~ 125 | ±30ppm |
| | | | | | | | |
| | | | | | | | |
| | | | | | | | |
| | | | | | | | |

ELECTRICAL CHARACTERISTICS - 2000V NP0 (COG) & X7R FOR DIFFERENT PART CODE

| NEXTGEN PART CODE | TEMP. COEFFICIENT | CAPACITANCE | TOLERANCE | VOLTAGE | THICKNESS (MAX.) | OPERATING TEMP. RANGE | CAPACITANCE CHARACTERISTIC |
|----------------------|----------------------|-------------|-----------|---------|---------------------|--------------------------|-------------------------------|
| | - | - | - | V | mm | °C | - |
| 1206B102K202BD | X7R | 1000 pF | ±10% | 2000 | 0.90 | -55 ~ 125 | ±15% |
| 1206B102K202DC | X7R | 1000 pF | ±10% | 2000 | 1.35 | -55 ~ 125 | ±15% |
| 1206B222K202GB | X7R | 2200 pF | ±10% | 2000 | 1.80 | -55 ~ 125 | ±15% |
| 1206B471K202DC | X7R | 470 pF | ±10% | 2000 | 1.35 | -55 ~ 125 | ±15% |
| 1206N101J202DC | NP0 (COG) | 100 pF | ±5% | 2000 | 1.35 | -55 ~ 125 | ±30ppm |
| 1206N330J202CC | NP0 (COG) | 33 pF | ±5% | 2000 | 1.05 | -55 ~ 125 | ±30ppm |
| 1210B102K202DC | X7R | 1000 pF | ±10% | 2000 | 1.35 | -55 ~ 125 | ±15% |
| 1210B152K202MA | X7R | 1500 pF | ±10% | 2000 | 2.80 | -55 ~ 125 | ±15% |
| 1808B222K202KA | X7R | 2200 pF | ±10% | 2000 | 2.20 | -55 ~ 125 | ±15% |
| 1812B102K202DA | X7R | 1000 pF | ±10% | 2000 | 1.35 | -55 ~ 125 | ±15% |
| 1812B103K202MK | X7R | 0.01 μF | ±10% | 2000 | 2.80 | -55 ~ 125 | ±15% |
| 1812B222K202DA | X7R | 2200 pF | ±10% | 2000 | 1.35 | -55 ~ 125 | ±15% |
| 1812B332K202KA | X7R | 3300 pF | ±10% | 2000 | 2.20 | -55 ~ 125 | ±15% |
| 1812B472K202KA | X7R | 4700 pF | ±10% | 2000 | 2.20 | -55 ~ 125 | ±15% |
| 1812N101J202DA | NP0 (COG) | 100 pF | ±5% | 2000 | 1.35 | -55 ~ 125 | ±30ppm |
| 1812N221J202DA | NP0 (COG) | 220 pF | ±5% | 2000 | 1.35 | -55 ~ 125 | ±30ppm |
| | | | | | | | |
| | | | | | | | |
| | | | | | | | |
| | | | | | | | |
| | | | | | | | |

ELECTRICAL CHARACTERISTICS - 3000V NP0 (COG) & X7R FOR DIFFERENT PART CODE

| NEXTGEN PART CODE | TEMP. COEFFICIENT | CAPACITANCE | TOLERANCE | VOLTAGE | THICKNESS (MAX.) | OPERATING TEMP. RANGE | CAPACITANCE CHARACTERISTIC |
|----------------------|----------------------|-------------|-----------|---------|---------------------|--------------------------|-------------------------------|
| | - | - | - | V | mm | °C | - |
| 1808N330J302DB | NP0 (COG) | 33 pF | ±5% | 3000 | 1.35 | -55 ~ 125 | ±30ppm |
| 1812B102K302KA | X7R | 1000 pF | ±10% | 3000 | 2.20 | -55 ~ 125 | ±15% |
| 1812N101K302DA | NP0 (COG) | 100 pF | ±10% | 3000 | 1.35 | -55 ~ 125 | ±30ppm |
| | | | | | | | |
| | | | | | | | |
| | | | | | | | |
| | | | | | | | |
| | | | | | | | |
| | | | | | | | |
| | | | | | | | |
| | | | | | | | |
| | | | | | | | |
| | | | | | | | |
| | | | | | | | |
| | | | | | | | |
| | | | | | | | |
| | | | | | | | |
| | | | | | | | |
| | | | | | | | |
| | | | | | | | |
| | | | | | | | |
| | | | | | | | |
| | | | | | | | |
| | | | | | | | |
| | | | | | | | |
| | | | | | | | |
| | | | | | | | |
| | | | | | | | |
| | | | | | | | |
| | | | | | | | |
| | | | | | | | |
| | | | | | | | |
| | | | | | | | |

DIMENSION (Unit: mm)

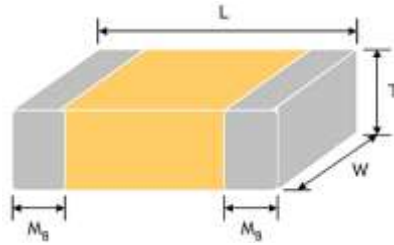

| SIZE CODE | METRIC CODE | L | W | T (SYMBOL) | | REMARK | MB |
|------------|-------------|-----------------|---------------|---------------|---|--------|---------------------------|
| | | | | | | | |
| 0805 | 2012 | 2.00 ±0.15 | 1.25 ±0.10 | 0.60±0.10 | A | | 0.50±0.20 |
| | | | | 0.80±0.10 | B | | |
| | | | | 1.25 ±0.10 | D | # | |
| | | 2.00 ±0.20 | 1.25 ±0.20 | 1.25 ±0.20 | I | # | |
| 1206 | 3216 | 3.20 ±0.15 | 1.60 ±0.15 | 0.80±0.10 | B | | 0.60±0.20 (0.50±0.25)* |
| | | | | 0.95±0.10 | C | # | |
| | | | | 1.25±0.10 | D | # | |
| | | 3.20 ±0. 20 | 1.60 ±0.20 | 1.60±0.20 | G | # | |
| | | 3.20 +0. 3/-0.1 | 1.60+0.3/-0.1 | 1.60+0.3/-0.1 | P | # | |
| 1210 | 3225 | 3.20 ±0.30 | 2.50 ±0.20 | 0.95±0.10 | C | # | 0.75±0.25 |
| | | | | 1.25±0.10 | D | # | |
| | | 3.20 ±0.40 | 2.50 ±0.30 | 1.60±0.20 | G | # | |
| | | | | 2.00±0.20 | K | # | |
| | | | | 2.50±0.30 | M | # | |
| 3.20 ±0.60 | 2.50 ±0.50 | 2.50±0.50 | M | # | | | |
| 1808 | 4520 | 4.50+0.5/-0.3 | 2.03±0.25 | 1.25±0.10 | D | # | 0.50±0.25 |
| | | | | 1.60±0.20 | G | # | |
| | | | | 2.00±0.20 | K | # | |

DIMENSION (Unit: mm)

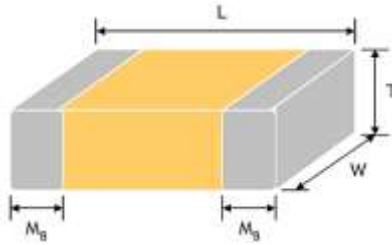

| SIZE CODE | METRIC CODE | L | W | T (SYMBOL) | | REMARK | MB |
|-----------|-------------|---------------|-----------|-------------|---|--------|-----------|
| | | | | | | | |
| 1812 | 4532 | 4.50+0.5/-0.3 | 3.20±0.30 | 1.25±0.10 | D | # | 0.50±0.25 |
| | | | | 1.60±0.20 | G | # | |
| | | | | 2.00±0.20 | K | # | |
| | | 4.50+0.5/-0.3 | 3.20±0.40 | 2.50±0.30 | M | # | |
| | | | | 2.80±0.30 | U | # | |
| 1825 | 4563 | 4.50±0.40 | 6.30±0.40 | 2.00±0.20 | K | # | 0.75±0.35 |
| | | | | 2.50±0.30 | M | # | |
| | | | | 2.80±0.30 | U | # | |
| 2220 | 5750 | 5.70±0.40 | 5.00±0.40 | 2.00±0.20 | K | # | 0.85±0.35 |
| | | | | 2.50±0.30 | M | # | |
| | | | | 2.80±0.30 | U | # | |
| 2225 | 5763 | 5.70±0.40 | 6.30±0.40 | 2.00±0.20 | K | # | 0.85±0.35 |
| | | | | 2.50±0.30 | M | # | |
| | | | | 2.80±0.30 | U | # | |

Note: 1) # Reflow soldering only is recommended. 2) * For 1206≥1000V~3000V products.

CONSTRUCTIONS



| NO. | NAME | | NPO | X7R |
|-----|------------------|-----------------|-------------|-------------|
| 1 | Ceramic Material | | CaZrO based | BaTiO based |
| 2 | Inner Electrode | | Ni | |
| 3 | Termination | Inner Electrode | Cu | |
| 4 | | Middle Layer | Ni | |
| 5 | | Outer Layer | Sn | |

GENERAL ELECTRONICAL CHARACTERISTICS

| DIELECTRIC | NPO | X7R |
|-------------------------------|-----------------------------------------------------------------------------------------------------|--------------------------------------|
| Size | 0805, 1206, 1210, 1808, 1812, 1825, 2220, 2225 | |
| Capacitance range* | 0.1pF to 0.1μF | 100pF to 22μF |
| Capacitance Tolerance*** | Cap≤5pF: C (±0.25pF) 5pF<Cap<10pF: D (±0.5pF) Cap≥10pF: F (±1%), G (±2%), J (±5%),K (±10%) | J (±5%) #1 K (±10%), M (±20%) |
| Rated Voltage (WVDC) | 1000V to 4000V | |
| Q/DF (Tan δ) * | Cap<30pF: Q≥400+20C Cap≥30pF: Q≥1000 | Cap<4.7μF: ≤2.5% Cap≥4.7μF: ≤3.5% |
| Insulation resistance at Ur** | Ur=1000~3000V: ≥10GΩ | |
| Dielectric strength | 1000~3000V: ≥1.2 x WVDC 4000: ≥1.1 x WVDC | |
| Operating Temperature | -55 ~+125°C | |
| Capacitance Characteristic | ±30ppm | ±15% |
| Termination | Ni/Sn (lead-free termination) | |

Note:

- #1: X7R products can provide optional J (±5%) capacitance tolerance.
- * Measured at the condition of 30~70% related humidity.
- NPO: Apply 1.0±0.2Vrms, 1.0MHz±10% for Cap≤1000pF and 1.0±0.2Vrms, 1.0kHz±10% for Cap>1000pF, 25°C at ambient temperature.
- X7R, X5R: Apply 1.0±0.2Vrms, 1.0kHz±10%, at 25°C ambient temperature.
- ** Preconditioning for Class II MLCC: Perform a heat treatment at 150±10°C for 1 hour, then leave in a ambient condition for 24±2 hours

CAPACITANCE RANGE - NP0 (COG) DIELECTRIC - SIZE 0805, 1206,1210

Table 1-A

| SIZE | 0805 | 1206 | | | 1210 | | |
|-------------|------|------|------|------|------|------|------|
| | | 1000 | 1500 | 2000 | 1000 | 1500 | 2000 |
| VDC (V) | 1000 | 1000 | 1500 | 2000 | 1000 | 1500 | 2000 |
| 0.5pF (0R5) | D | | | | | | |
| 1.0pF (1R0) | D | | | | | | |
| 1.2pF (1R2) | D | | | | | | |
| 1.5pF (1R5) | D | B | B | B | | | |
| 1.8pF (1R8) | D | B | B | B | | | |
| 2.0pF (2R0) | D | B | B | B | | | |
| 2.2pF (2R2) | D | B | B | B | | | |
| 2.7pF (2R7) | D | B | B | B | | | |
| 3.3pF (3R3) | D | B | B | B | | | |
| 3.9pF (3R9) | D | B | B | B | | | |
| 4.7pF (4R7) | D | B | B | B | | | |
| 5.6pF (5R6) | D | B | B | B | | | |
| 6.8pF (6R8) | D | B | B | B | | | |
| 8.2pF (8R2) | D | B | B | B | | | |
| 10pF (100) | D | B | B | B | C | C | C |
| 12pF (120) | D | B | B | B | C | C | C |
| 15pF (150) | D | B | B | B | C | C | C |
| 18pF (180) | D | B | B | B | C | C | C |
| 22pF (220) | D | B | B | B | C | C | C |
| 27pF (270) | D | B | B | B | C | C | C |
| 33pF (330) | D | B | C | C | C | C | C |
| 39pF (390) | D | B | C | C | C | C | C |
| 47pF (470) | D | B | C | C | C | C | C |
| 56pF (560) | D | B | D | D | C | D | D |
| 68pF (680) | D | B | D | D | C | D | D |
| 82pF (820) | D | B | D | D | C | D | D |
| 100pF (101) | D | B | D | D | D | D | D |
| 120pF (121) | D | D | G | G | D | D | D |
| 150pF (151) | D | D | G | G | D | G | G |
| 180pF (181) | D | G | G | G | D | G | G |

CAPACITANCE RANGE - NP0 (COG) DIELECTRIC - SIZE 0805, 1206,1210

Table 1-B

| SIZE | 0805 | 1206 | | | 1210 | | |
|---------------|------|------|------|------|------|------|------|
| VDC (V) | 1000 | 1000 | 1500 | 2000 | 1000 | 1500 | 2000 |
| 220pF (221) | D | G | G | G | G | G | G |
| 270pF (271) | D | G | P | P | G | K | K |
| 330pF (331) | D | G | P | P | G | K | K |
| 390pF (391) | D | G | P | P | G | M | M |
| 470pF (471) | | G | | | G | M | M |
| 560pF (561) | | G | | | G | | |
| 680pF (681) | | G | | | G | | |
| 820pF (821) | | G | | | G | | |
| 1,000pF (102) | | G | | | G | | |
| 1,200pF (122) | | G | | | K | | |
| 1,500pF (152) | | G | | | K | | |
| 1,800pF (182) | | G | | | K | | |
| 2,200pF (222) | | G | | | K | | |
| 2,700pF (272) | | G | | | K | | |
| 3,300pF (332) | | G | | | K | | |
| 3,900pF (392) | | G | | | K | | |
| 4,700pF (472) | | G | | | K | | |
| 5,600pF (562) | | | | | K | | |
| 6,800pF (682) | | | | | K | | |
| 8,200pF (822) | | | | | K | | |
| 0.010µF (103) | | | | | M | | |
| 0.012µF (123) | | | | | M | | |
| 0.015µF (153) | | | | | M | | |
| 0.018µF (183) | | | | | M | | |
| 0.022µF (223) | | | | | M | | |
| | | | | | | | |
| | | | | | | | |
| | | | | | | | |
| | | | | | | | |
| | | | | | | | |
| | | | | | | | |

CAPACITANCE RANGE - NP0 (COG) DIELECTRIC - SIZE 1808, 1812

Table 1-C

| Size | 1808 | | | | | 1812 | | | | | |
|-------------|---------|------|------|------|------|------|------|------|------|------|------|
| | VDC (V) | 1000 | 1500 | 2000 | 3000 | 4000 | 1000 | 1500 | 2000 | 3000 | 4000 |
| 2.0pF (2R0) | D | D | D | D | | | | | | | |
| 2.2pF (2R2) | D | D | D | D | | | | | | | |
| 2.7pF (2R7) | D | D | D | D | | | | | | | |
| 3.3pF (3R3) | D | D | D | D | | | | | | | |
| 3.9pF (3R9) | D | D | D | D | | | | | | | |
| 4.7pF (4R7) | D | D | D | D | | | | | | | |
| 5.6pF (5R6) | D | D | D | D | | | | | | | |
| 6.8pF (6R8) | D | D | D | D | | | | | | | |
| 8.2pF (8R2) | D | D | D | D | | | | | | | |
| 10pF (100) | D | D | D | D | D | D | D | D | D | D | D |
| 12pF (120) | D | D | D | D | D | D | D | D | D | D | D |
| 15pF (150) | D | D | D | D | D | D | D | D | D | D | D |
| 18pF (180) | D | D | D | D | D | D | D | D | D | D | D |
| 22pF (220) | D | D | D | D | G | D | D | D | D | D | D |
| 27pF (270) | D | D | D | D | G | D | D | D | D | D | D |
| 33pF (330) | D | D | D | D | | D | D | D | D | | |
| 39pF (390) | D | D | D | D | | D | D | D | D | | |
| 47pF (470) | D | D | D | D | | D | D | D | D | | |
| 56pF (560) | D | D | D | D | | D | D | D | D | | |
| 68pF (680) | D | D | D | D | | D | D | D | D | | |
| 82pF (820) | D | D | D | D | | D | D | D | D | | |
| 100pF (101) | D | D | D | K | | D | D | D | D | | |
| 120pF (121) | D | D | D | K | | D | D | D | D | | |
| 150pF (151) | D | K | K | K | | D | D | D | D | | |
| 180pF (181) | D | K | K | K | | D | D | D | K | | |
| 220pF (221) | D | K | K | K | | D | D | D | K | | |
| 270pF (271) | K | K | K | K | | D | K | K | K | | |
| 330pF (331) | K | K | K | K | | D | K | K | K | | |
| 390pF (391) | K | K | K | K | | D | K | K | K | | |
| 470pF (471) | K | K | K | | | K | K | K | K | | |

CAPACITANCE RANGE - NP0 (COG) DIELECTRIC - SIZE 1808, 1812

Table 1-D

| SIZE | 1808 | | | | | 1812 | | | | | |
|---------------|---------|------|------|------|------|------|------|------|------|------|------|
| | VDC (V) | 1000 | 1500 | 2000 | 3000 | 4000 | 1000 | 1500 | 2000 | 3000 | 4000 |
| 560pF (561) | K | K | K | | | | K | K | K | | |
| 680pF (681) | K | K | K | | | | K | K | K | | |
| 820pF (821) | K | D | D | | | | K | K | K | | |
| 1,000pF (102) | K | G | G | | | | K | K | K | | |
| 1,200pF (122) | G | G | G | | | | K | | | | |
| 1,500pF (152) | K | K | K | | | | K | | | | |
| 1,800pF (182) | K | K | K | | | | K | | | | |
| 2,200pF (222) | K | K | K | | | | K | | | | |
| 2,700pF (272) | K | | | | | | K | | | | |
| 3,300pF (332) | K | | | | | | K | | | | |
| 3,900pF (392) | | | | | | | M | | | | |
| 4,700pF (472) | | | | | | | M | | | | |
| 5,600pF (562) | | | | | | | M | | | | |

CAPACITANCE RANGE - NP0 (COG) DIELECTRIC - SIZE 1825, 2220

Table 1-E

| SIZE | 1825 | | | | 2220 | | | | |
|---------------|---------|------|------|------|------|------|------|------|------|
| | VDC (V) | 1000 | 2000 | 3000 | 4000 | 1000 | 2000 | 3000 | 4000 |
| 10pF (100) | K | K | K | K | K | K | K | K | K |
| 12pF (120) | K | K | K | K | K | K | K | K | K |
| 15pF (150) | K | K | K | K | K | K | K | K | K |
| 18pF (180) | K | K | K | K | K | K | K | K | K |
| 22pF (220) | K | K | K | K | K | K | K | K | K |
| 27pF (270) | K | K | K | K | K | K | K | K | K |
| 33pF (330) | K | K | K | K | K | K | K | K | K |
| 39pF (390) | K | K | K | K | K | K | K | K | K |
| 47pF (470) | K | K | K | K | K | K | K | K | K |
| 56pF (560) | K | K | K | K | K | K | K | K | K |
| 68pF (680) | K | K | K | K | K | K | K | K | K |
| 82pF (820) | K | K | K | K | K | K | K | K | K |
| 100pF (101) | K | K | K | K | K | K | K | K | K |
| 120pF (121) | K | K | K | | K | K | K | | |
| 150pF (151) | K | K | K | | K | K | K | | |
| 180pF (181) | K | K | K | | K | K | K | | |
| 220pF (221) | K | K | K | | K | K | K | | |
| 270pF (271) | K | K | K | | K | K | M | | |
| 330pF (331) | K | K | K | | K | K | M | | |
| 390pF (391) | K | K | K | | K | K | M | | |
| 470pF (471) | K | K | K | | K | K | M | | |
| 560pF (561) | K | K | K | | K | K | M | | |
| 680pF (681) | K | K | M | | K | K | M | | |
| 820pF (821) | K | K | M | | K | K | M | | |
| 1,000pF (102) | K | K | M | | K | K | M | | |
| 1,200pF (122) | K | K | | | M | M | M | | |
| 1,500pF (152) | K | M | | | M | M | M | | |
| 1,800pF (182) | K | M | | | M | M | | | |
| 2,200pF (222) | K | M | | | M | M | | | |
| 2,700pF (272) | K | M | | | M | M | | | |

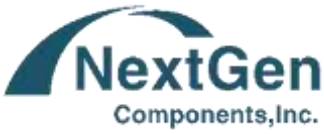

PART CODE: **1206N471J102GB**

HIGH VOLTAGE MULTILAYER CERAMIC CHIP CAPACITORS

CAPACITANCE RANGE - NP0 (COG) DIELECTRIC - SIZE 1825, 2220

Table 1-F

| SIZE VDC (V) | 1825 | | | | 2220 | | | |
|-----------------|------|------|------|------|------|------|------|------|
| | 1000 | 2000 | 3000 | 4000 | 1000 | 2000 | 3000 | 4000 |
| 3,300pF (332) | K | M | | | M | M | | |
| 3,900pF (392) | M | M | | | M | M | | |
| 4,700pF (472) | M | M | | | M | M | | |
| 5,600pF (562) | M | | | | M | | | |
| 6,800pF (682) | M | | | | M | | | |
| 8,200pF (822) | M | | | | M | | | |
| 0.010μF (103) | M | | | | M | | | |
| | | | | | | | | |
| | | | | | | | | |
| | | | | | | | | |
| | | | | | | | | |
| | | | | | | | | |
| | | | | | | | | |
| | | | | | | | | |
| | | | | | | | | |
| | | | | | | | | |
| | | | | | | | | |
| | | | | | | | | |
| | | | | | | | | |
| | | | | | | | | |
| | | | | | | | | |
| | | | | | | | | |
| | | | | | | | | |
| | | | | | | | | |
| | | | | | | | | |
| | | | | | | | | |
| | | | | | | | | |
| | | | | | | | | |
| | | | | | | | | |
| | | | | | | | | |
| | | | | | | | | |
| | | | | | | | | |
| | | | | | | | | |

CAPACITANCE RANGE - NP0 (COG) DIELECTRIC - SIZE 2225

Table 1-G

| SIZE | 2225 | | | |
|---------------|------|------|------|------|
| | 1000 | 2000 | 3000 | 4000 |
| VDC (V) | | | | |
| 10pF (100) | K | K | K | K |
| 12pF (120) | K | K | K | K |
| 15pF (150) | K | K | K | K |
| 18pF (180) | K | K | K | K |
| 22pF (220) | K | K | K | K |
| 27pF (270) | K | K | K | K |
| 33pF (330) | K | K | K | K |
| 39pF (390) | K | K | K | K |
| 47pF (470) | K | K | K | K |
| 56pF (560) | K | K | K | K |
| 68pF (680) | K | K | K | K |
| 82pF (820) | K | K | K | K |
| 100pF (101) | K | K | K | K |
| 120pF (121) | K | K | K | |
| 150pF (151) | K | K | K | |
| 180pF (181) | K | K | K | |
| 220pF (221) | K | K | K | |
| 270pF (271) | K | K | K | |
| 330pF (331) | K | K | K | |
| 390pF (391) | K | K | K | |
| 470pF (471) | K | K | K | |
| 560pF (561) | K | K | K | |
| 680pF (681) | K | K | K | |
| 820pF (821) | K | M | M | |
| 1,000pF (102) | K | M | M | |
| 1,200pF (122) | K | M | | |
| 1,500pF (152) | K | M | | |
| 1,800pF (182) | K | M | | |
| 2,200pF (222) | K | M | | |
| 2,700pF (272) | K | M | | |

CAPACITANCE RANGE – X7R DIELECTRIC - SIZE 805, 1206,1210

Table 2-A

| SIZE | 0805 | 1206 | | | | 1210 | | |
|---------------|------|------|------|------|------|------|------|------|
| VDC (V) | 1000 | 1000 | 1500 | 2000 | 2500 | 1000 | 1500 | 2000 |
| 100pF (101) | B | D | D | D | D | D | D | D |
| 120pF (121) | B | D | D | D | D | D | D | D |
| 150pF (151) | B | D | D | D | D | D | D | D |
| 180pF (181) | B | D | D | D | D | D | D | D |
| 220pF (221) | B | B | D | B | D | D | D | D |
| 270pF (271) | B | D | D | D | D | D | D | D |
| 330pF (331) | B | D | D | D | D | D | D | D |
| 390pF (391) | B | D | D | D | D | D | D | D |
| 470pF (471) | B | D | D | D | D | D | D | D |
| 560pF (561) | B | D | D | D | D | D | D | D |
| 680pF (681) | B | D | D | D | D | D | D | D |
| 820pF (821) | B | D | D | D | D | D | D | D |
| 1,000pF (102) | B | D | D | D | D | D | D | D |
| 1,200pF (122) | B | D | G | G | G | D | M | M |
| 1,500pF (152) | D | D | G | G | G | D | M | M |
| 1,800pF (182) | D | D | G | G | G | D | M | M |
| 2,200pF (222) | D | D | G | G | G | D | M | M |
| 2,700pF (272) | D | D | G | G | | D | M | M |
| 3,300pF (332) | D | D | G | G | | D | M | M |
| 3,900pF (392) | D | D | G | | | G | M | M |
| 4,700pF (472) | D | D | G | | | G | M | M |
| 5,600pF (562) | D | D | G | | | G | M | M |
| 6,800pF (682) | D | D | G | | | G | M | M |
| 8,200pF (822) | D | D | G | | | G | M | M |
| 0.010µF (103) | D | D | G | | | G | M | |
| 0.012µF (123) | | G | | | | G | | |
| 0.015µF (153) | | G | | | | G | | |
| 0.018µF (183) | | | | | | G | | |
| 0.033µF (333) | | | | | | G | | |
| 0.039µF (393) | | | | | | K | | |
| 0.047µF (473) | | | | | | M | | |

CAPACITANCE RANGE – X7R DIELECTRIC - SIZE 1808, 1812

Table 2-B

| Size | 1808 | | | | | 1812 | | | | | |
|---------------|---------|------|------|------|------|------|------|------|------|------|------|
| | VDC (V) | 1000 | 1500 | 2000 | 3000 | 4000 | 1000 | 1500 | 2000 | 3000 | 4000 |
| 150pF (151) | D | D | D | D | K | | | | | | |
| 180pF (181) | D | D | D | D | K | | | | | | |
| 220pF (221) | D | D | D | D | K | | | | | | |
| 270pF (271) | D | D | D | D | K | D | D | D | K | K | |
| 330pF (331) | D | D | D | K | K | D | D | D | K | K | |
| 390pF (391) | D | D | D | K | K | D | D | D | K | K | |
| 470pF (471) | D | D | D | K | K | D | D | D | K | K | |
| 560pF (561) | D | D | D | K | K | D | D | D | K | K | |
| 680pF (681) | D | D | D | K | K | D | D | D | K | K | |
| 820pF (821) | D | D | D | K | K | D | D | D | K | K | |
| 1,000pF (102) | D | K | K | K | K | D | D | D | K | K | |
| 1,200pF (122) | D | K | K | K | | D | D | D | K | M | |
| 1,500pF (152) | D | K | K | K | | D | D | D | K | M | |
| 1,800pF (182) | D | K | K | K | | D | D | D | M | M | |
| 2,200pF (222) | D | K | K | K | | D | D | D | M | | |
| 2,700pF (272) | D | K | K | K | | D | D | D | M | | |
| 3,300pF (332) | D | K | K | K | | D | K | K | M | | |
| 3,900pF (392) | D | K | K | | | D | K | K | M | | |
| 4,700pF (472) | D | K | K | | | D | K | K | M | | |
| 5,600pF (562) | K | K | K | | | D | M | M | M | | |
| 6,800pF (682) | K | K | K | | | D | M | M | M | | |
| 8,200pF (822) | K | K | K | | | D | M | M | | | |
| 0.010μF (103) | K | K | K | | | D | M | M | | | |
| 0.012μF (123) | K | | | | | K | M | M | | | |
| 0.015μF (153) | K | | | | | K | M | M | | | |
| 0.018μF (183) | K | | | | | M | M | M | | | |

CAPACITANCE RANGE – X7R DIELECTRIC - SIZE 1808, 1812

Table 2-C

| Size | 1808 | | | | | 1812 | | | | |
|---------------------|------|------|------|------|------|------|------|------|------|------|
| VDC (V) | 1000 | 1500 | 2000 | 3000 | 4000 | 1000 | 1500 | 2000 | 3000 | 4000 |
| 0.022 μ F (223) | | | | | | M | M | M | | |
| 0.033 μ F (333) | K | | | | | M | | | | |
| 0.039 μ F (393) | K | | | | | M | | | | |
| 0.047 μ F (473) | K | | | | | M | | | | |
| 0.056 μ F (563) | K | | | | | M | | | | |
| 0.068 μ F (683) | | | | | | M | | | | |
| 0.10 μ F (104) | | | | | | M | | | | |
| | | | | | | | | | | |
| | | | | | | | | | | |
| | | | | | | | | | | |
| | | | | | | | | | | |
| | | | | | | | | | | |
| | | | | | | | | | | |
| | | | | | | | | | | |
| | | | | | | | | | | |
| | | | | | | | | | | |
| | | | | | | | | | | |
| | | | | | | | | | | |
| | | | | | | | | | | |
| | | | | | | | | | | |
| | | | | | | | | | | |
| | | | | | | | | | | |
| | | | | | | | | | | |
| | | | | | | | | | | |
| | | | | | | | | | | |
| | | | | | | | | | | |
| | | | | | | | | | | |
| | | | | | | | | | | |
| | | | | | | | | | | |
| | | | | | | | | | | |
| | | | | | | | | | | |

CAPACITANCE RANGE – X7R DIELECTRIC - SIZE 1825, 2220

Table 2-D

| SIZE | 1825 | | | | | 2220 | | | | | | |
|---------------|---------|------|------|------|------|------|------|------|------|------|------|------|
| | VDC (V) | 1000 | 1500 | 2000 | 3000 | 4000 | 1000 | 1500 | 2000 | 2500 | 3000 | 4000 |
| 1,000pF (102) | K | K | K | K | K | K | K | K | K | K | K | K |
| 1,200pF (122) | K | K | K | K | M | K | K | K | K | K | K | M |
| 1,500pF (152) | K | M | K | K | M | K | K | K | K | K | K | M |
| 1,800pF (182) | K | M | K | K | M | K | K | K | K | K | K | M |
| 2,200pF (222) | K | M | K | K | | K | K | K | K | K | K | |
| 2,700pF (272) | K | M | K | K | | K | K | K | K | K | K | |
| 3,300pF (332) | K | K | K | K | | K | K | K | K | K | K | |
| 3,900pF (392) | K | K | K | K | | K | K | K | K | K | K | |
| 4,700pF (472) | K | K | K | K | | K | K | K | K | K | K | |
| 5,600pF (562) | K | K | K | M | | K | K | K | K | K | K | |
| 6,800pF (682) | K | K | K | M | | K | K | K | M | M | | |
| 8,200pF (822) | K | K | K | M | | K | M | M | M | M | | |
| 0.010μF (103) | K | K | K | M | | K | M | M | M | M | | |
| 0.012μF (123) | K | M | M | U | | K | M | M | U | U | | |
| 0.015μF (153) | K | M | M | U | | K | M | M | U | U | | |
| 0.018μF (183) | K | M | M | U | | K | U | U | U | U | | |
| 0.022μF (223) | K | M | M | | | K | U | U | | | | |
| 0.027μF (273) | K | U | U | | | K | U | U | | | | |
| 0.033μF (333) | K | U | U | | | K | U | U | | | | |
| 0.039μF (393) | K | U | U | | | K | U | U | | | | |
| 0.047μF (473) | K | U | U | | | K | U | U | | | | |
| 0.056μF (563) | K | | | | | K | U | U | | | | |
| 0.068μF (683) | K | | | | | M | | | | | | |
| 0.082μF (823) | M | | | | | M | | | | | | |
| 0.10μF (104) | M | | | | | M | | | | | | |
| 0.12μF (124) | | | | | | M | | | | | | |
| 0.15μF (154) | | | | | | U | | | | | | |
| 0.18μF (184) | | | | | | U | | | | | | |
| 0.22μF (224) | | | | | | U | | | | | | |
| | | | | | | | | | | | | |

CAPACITANCE RANGE – X7R DIELECTRIC - SIZE 2225

Table 2-E

| SIZE | 2225 | | | | |
|---------------|------|------|------|------|------|
| VDC (V) | 1000 | 1500 | 2000 | 3000 | 4000 |
| 1,000pF (102) | K | K | K | K | K |
| 1,200pF (122) | K | K | K | K | M |
| 1,500pF (152) | K | K | K | K | M |
| 1,800pF (182) | K | K | K | K | M |
| 2,200pF (222) | K | K | K | K | |
| 2,700pF (272) | K | K | K | K | |
| 3,300pF (332) | K | K | K | K | |
| 3,900pF (392) | K | K | K | K | |
| 4,700pF (472) | K | K | K | K | |
| 5,600pF (562) | K | K | K | M | |
| 6,800pF (682) | K | K | K | M | |
| 8,200pF (822) | K | K | K | M | |
| 0.010μF (103) | K | K | K | M | |
| 0.012μF (123) | K | M | M | M | |
| 0.015μF (153) | K | M | M | M | |
| 0.018μF (183) | K | M | M | U | |
| 0.022μF (223) | K | M | M | | |
| 0.027μF (273) | K | M | M | | |
| 0.033μF (333) | K | M | M | | |
| 0.039μF (393) | K | U | U | | |
| 0.047μF (473) | K | U | U | | |
| 0.056μF (563) | K | U | U | | |
| 0.068μF (683) | K | | | | |
| 0.082μF (823) | K | | | | |
| 0.10μF (104) | M | | | | |
| 0.12μF (124) | U | | | | |
| 0.15μF (154) | U | | | | |
| 0.18μF (184) | U | | | | |
| 0.22μF (224) | U | | | | |
| | | | | | |

RELIABILITY TEST CONDITIONS AND REQUIREMENTS

| ITEM | TEST CONDITION | REQUIREMENTS | | | | | | | | | | | | |
|-------------------------------|--------------------------------------------------------------------------------------------------------------------------------------------------------------------------------------------------------------------------------------------------------------------------------------------------------------------------------------------------------------------------------------------------------------------------------------------------------|----------------------------------------------------------------------------------------------------------------------------------------|------------|-----------|-------------------|-----|-------------------|-------------------------------------------------------------------------------------------------------------------------------------------------------------------------------------------------------------------------------------------------------|-----|--------------------|-----------|------------------|-----|-------------|
| Visual and Mechanical | - | <ul style="list-style-type: none"> * No remarkable defect. * Dimensions to conform to individual spec. sheet. | | | | | | | | | | | | |
| Capacitance | <ul style="list-style-type: none"> * Test temp.: Room Temperature. Class I: NPO (COG) | * Shall not exceed the limits given in the detailed spec. | | | | | | | | | | | | |
| Q/D.F (Dissipation Factor) | <ul style="list-style-type: none"> • Cap ≤ 1000pF, 1.0 ± 0.2Vrms, 1MHz ± 10% • Cap > 1000pF, 1.0 ± 0.2Vrms, 1KHz ± 10% Class II: X7R : 1.0 ± 0.2Vrms, 1KHz ± 10% *Before initial measurement (Class II only): To apply de-aging at 150° C for 1hr then set for 24 ± 2 hour at room temp. | NPO (COG): <ul style="list-style-type: none"> • Cap ≥ 30pF, Q ≥ 1000; • Cap < 30pF, Q ≥ 400+20C X7R: ≤ 2.5% | | | | | | | | | | | | |
| Dielectric Strength | <ul style="list-style-type: none"> * To apply voltage: 1000V~3000V ≥ 1.2 times VDC 4000V ≥ 1.1 times VDC * Duration: 1 to 5 sec. * Charge & discharge current less than 50mA | * No evidence of damage or flash over during test. | | | | | | | | | | | | |
| Insulation Resistance | <ul style="list-style-type: none"> * Test temp.: Room Temperature. Rated voltage: ≥ 630V (To apply 500V for 60 sec.) To apply rated voltage (500V max.) for 60 sec | ≥ 10GΩ or RxC ≥ 100Ω-F whichever is smaller | | | | | | | | | | | | |
| Temperature Coefficient | With no electrical load. <table border="1" data-bbox="345 1435 841 1622"> <thead> <tr> <th>T.C</th> <th>Temp. (°C)</th> </tr> </thead> <tbody> <tr> <td>NPO (COG)</td> <td>-55~125°C at 25°C</td> </tr> <tr> <td>X7R</td> <td>-55~125°C at 25°C</td> </tr> </tbody> </table> <ul style="list-style-type: none"> *Before initial measurement (Class II only): To apply de-aging at 150° C for 1hr then set for 24 ± 2 hours at room temp | T.C | Temp. (°C) | NPO (COG) | -55~125°C at 25°C | X7R | -55~125°C at 25°C | <table border="1" data-bbox="996 1446 1332 1725"> <thead> <tr> <th>T.C</th> <th>Capacitance Change</th> </tr> </thead> <tbody> <tr> <td>NPO (COG)</td> <td>Within ±30ppm/°C</td> </tr> <tr> <td>X7R</td> <td>Within ±15%</td> </tr> </tbody> </table> | T.C | Capacitance Change | NPO (COG) | Within ±30ppm/°C | X7R | Within ±15% |
| T.C | Temp. (°C) | | | | | | | | | | | | | |
| NPO (COG) | -55~125°C at 25°C | | | | | | | | | | | | | |
| X7R | -55~125°C at 25°C | | | | | | | | | | | | | |
| T.C | Capacitance Change | | | | | | | | | | | | | |
| NPO (COG) | Within ±30ppm/°C | | | | | | | | | | | | | |
| X7R | Within ±15% | | | | | | | | | | | | | |

RELIABILITY TEST CONDITIONS AND REQUIREMENTS

| ITEM | TEST CONDITION | REQUIREMENTS | | | | | | | | | | | | | | | |
|----------------------------------|----------------------------------------------------------------------------------------------------------------------------------------------------------------------------------------------------------------------------------------------------------------------------------------------------------------------------------------------------------------------------------------------------------------------------------------------------------------------------------------------------------------------------------------------------------------------------------------------------------------------------------------------------------------------------------------------------------------------------------------------------------------------------------------------------------------------------------------------------------------------------------------------------------------------------------------------------|-----------------------------------------------------------------------------------------------------------------------------------------------------------------------------------------------------------------------------------------------------------------------------------------------------------------------------------------------------------------|-----------------------------|-----------|---|---------------------------|------------|---|------------|-----|---|---------------------------|------------|---|------------|-----|-----------------------------------------------------------------------------------------------------------------------------------------------------------------------------------------------------------------------------------------------------------------------------------------------------------------------------------------------------------------------------------|
| Adhesive Strength of Termination | <ul style="list-style-type: none"> * Pressurizing force: 5N (≤ 0603) and 10N (>0603) * Test time: 10 ± 1 sec. | <ul style="list-style-type: none"> * No remarkable damage or removal of the terminations. | | | | | | | | | | | | | | | |
| Solderability | <ul style="list-style-type: none"> * Solder temperature: $235 \pm 5^\circ \text{C}$ * Dipping time: 2 ± 0.5 sec. | 95% min. coverage of all metalized area. | | | | | | | | | | | | | | | |
| Resistance to Soldering Heat | <ul style="list-style-type: none"> * Solder temperature: $260 \pm 5^\circ \text{C}$ * Dipping time: 10 ± 1 sec * Preheating: 120 to 150°C for 1 minute before immerse the capacitor in a eutectic solder. * Before initial measurement (Class II only): To apply de-gaging at 150°C for 1hr then set for 24 ± 2 hours at room temp * Cap. / DF(Q) / I.R. Measurement to be made after de-gaging at 150°C for 1hr then set for 24 ± 2 hours at room temp. | <ul style="list-style-type: none"> * No remarkable damage. * Cap change: NP0: within $\pm 2.5\%$ or $\pm 0.25\text{pF}$ whichever is larger. X7R: within $\pm 7.5\%$ * Q/D.F., I.R. and dielectric strength: To meet initial requirements. * 25% max. leaching on each edge. | | | | | | | | | | | | | | | |
| Temperature Cycle | <p>*Conduct the five cycles according to the temperatures and time.</p> <table border="1" data-bbox="341 1313 943 1624"> <thead> <tr> <th>Step</th> <th>Temp. ($^\circ \text{C}$)</th> <th>Time(min)</th> </tr> </thead> <tbody> <tr> <td>1</td> <td>Min. operating temp.+0/-3</td> <td>30 ± 3</td> </tr> <tr> <td>2</td> <td>Room temp.</td> <td>2~3</td> </tr> <tr> <td>3</td> <td>Max. operating temp.+3/-0</td> <td>30 ± 3</td> </tr> <tr> <td>4</td> <td>Room temp.</td> <td>2~3</td> </tr> </tbody> </table> <ul style="list-style-type: none"> * Before initial measurement (Class II only): Perform 150°C for 1 hour and then set for 24 ± 2 hours at room temp.. * Cap. / DF(Q) / I.R. Measurement to be made after de-gaging at 150°C for 1hr then set for 24 ± 2 hours at room temp. | Step | Temp. ($^\circ \text{C}$) | Time(min) | 1 | Min. operating temp.+0/-3 | 30 ± 3 | 2 | Room temp. | 2~3 | 3 | Max. operating temp.+3/-0 | 30 ± 3 | 4 | Room temp. | 2~3 | <ul style="list-style-type: none"> * No remarkable damage. * Cap change: <ul style="list-style-type: none"> • NP0 (COG): within $\pm 2.5\%$ or $\pm 0.25\text{pF}$ whichever is larger • X7R: within $\pm 7.5\%$ * Q/D.F., I.R. and dielectric strength: To meet initial requirements. |
| Step | Temp. ($^\circ \text{C}$) | Time(min) | | | | | | | | | | | | | | | |
| 1 | Min. operating temp.+0/-3 | 30 ± 3 | | | | | | | | | | | | | | | |
| 2 | Room temp. | 2~3 | | | | | | | | | | | | | | | |
| 3 | Max. operating temp.+3/-0 | 30 ± 3 | | | | | | | | | | | | | | | |
| 4 | Room temp. | 2~3 | | | | | | | | | | | | | | | |

RELIABILITY TEST CONDITIONS AND REQUIREMENTS

| ITEM | TEST CONDITION | REQUIREMENTS |
|------------------------------------------|----------------------------------------------------------------------------------------------------------------------------------------------------------------------------------------------------------------------------------------------------------------------------------------------------------------------------------------------------------------------------------------------------------------------------------------------------------|------------------------------------------------------------------------------------------------------------------------------------------------------------------------------------------------------------------------------------------------------------------------------------------------------------------------------------------------------------------------------------------------------------------------------------|
| <p>Vibration Resistance</p> | <p>* Vibration frequency: 10~55 Hz/min. * Total amplitude: 1.5mm * Test time: 6 hrs. (Two hours each in three mutually perpendicular directions.) *Before initial measurement (Class II only): To apply de-aging at 150° C for 1hr then set for 24 ± 2 hours at room temp . *Cap./DF(Q) Measurement to be made after de-aging at 150° C for 1hr then set for 24 ± 2 hours at room temp.</p> | <p>* No remarkable damage. * Cap change and Q/D.F.: To meet initial spec.</p> |
| <p>Bending Test</p> | <p>* The middle part of substrate shall be pressurized by means of the pressurizing rod at a rate of about 1 mm per second until the deflection becomes 1 mm and then the pressure shall be maintained for 5 ± 1 sec. *Before initial measurement (Class II only): To apply de-aging at 150° C for 1hr then set for 24 ± 2 hours at room temp . * Measurement to be made after keeping at room temp. for 24 ± 2 hours.</p> | <p>* No remarkable damage. * Cap change: NP0: within ± 5.0% or ± 0.5pF whichever is larger. X7R: within ± 12.5% (This capacitance change means the change of capacitance under specified flexure of substrate from the capacitance measured before the test.)</p> |
| <p>Humidity (Damp Heat) Steady State</p> | <p>*Test temp.: 40 ± 2° C *Humidity: 90~95% RH *Test time: 500+24/-0 hours. *Before initial measurement (Class II only): To apply de-aging at 150° C for 1hr then set for 24 ± 2 hours at room temp . * Cap. / DF(Q) / I.R. Measurement to be made after de-aging at 150° C for 1hr then set for 24 ± 2 hours at room temp</p> | <p>* No remarkable damage. * Cap change: NP0 within ± 5% or ± 0.5pF whichever is larger X7R within ± 12.5% * Q/D.F Value: NP0: Cap ≥ 30pF : Q ≥ 350 10pF ≤ Cap < 30pF : Q ≥ 275 + 2.5C Cap < 10pF : Q ≥ 200 + 10C X7R: ≤ 3.0% * I.R.: ≥ 1GΩ or Rx C ≥ 50Ω-F whichever is smaller.</p> |

RELIABILITY TEST CONDITIONS AND REQUIREMENTS

| ITEM | TEST CONDITION | REQUIREMENTS |
|--------------------------------------------|---------------------------------------------------------------------------------------------------------------------------------------------------------------------------------------------------------------------------------------------------------------------------------------------------------------------------------------------------------------------------------------------------------------------------------------------------------------------------------------------------------------------------------------------------------------------------------------------------------------------------------------------------------------------------------------------------------------------------------------------------------------------------------------|-----------------------------------------------------------------------------------------------------------------------------------------------------------------------------------------------------------------------------------------------------------------------------------------------------------------------------------------------------------------------------------------------------------------------------------------------------------------------------------------------------------------------------------------------------------------------------------------------------------------------------------------------------------------------------------------------------------------------------------|
| Humidity (Damp Heat) Load | <ul style="list-style-type: none"> * Test temp.: $40 \pm 2^\circ \text{C}$ * Humidity: 90~95%RH * Test time: 500+24/-0 hours. * To apply voltage: rated voltage (Max. 500V) * Before initial measurement (Class II only): To apply de-aging at 150°C for 1hr then set for 24 ± 2 hours at room temp . * Cap. / DF(Q) / I.R. Measurement to be made after de-aging at 150°C for 1 hour then set for 24 ± 2 hours at room temp. | <ul style="list-style-type: none"> * No remarkable damage. * Cap change: NP0: within $\pm 7.5\%$ or $\pm 0.75\text{pF}$ whichever is larger. X7R: within $\pm 12.5\%$ * Q/D.F. value: NP0: $\text{Cap} \geq 30\text{pF}$, $\text{Q} \geq 200$; $\text{Cap} < 30\text{pF}$, $\text{Q} \geq 100 + 10/3\text{C}$ X7R: $\leq 3.0\%$ • I.R.: $\geq 500\text{M}\Omega$ or $\text{RxC} \geq 25\Omega\text{-F}$ whichever is smaller. |
| High Temperature Load (Endurance) | <ul style="list-style-type: none"> * Test temp.: NP0, X7R: $125 \pm 3^\circ \text{C}$ * To apply voltage: • 1206/NP0 (3kV) $\geq 1.5\text{pF}$: 100% of rated voltage. 1812N472 & 1812N562(1KV): 100% of rated voltage. • 1000V~3000V: 120% of rated voltage. • 4000V: 110% of rated voltage. * Test time: 1000+24/-0 hrs. * Before initial measurement (Class II only): To apply de-aging at 150°C for 1hr then set for 24 ± 2 hours at room temp . • Cap. / DF(Q) / I.R. Measurement to be made after de-aging at 150°C for 1hr then set for 24 ± 2 hours at room temp. | <ul style="list-style-type: none"> * No remarkable damage. * Cap change: NP0: within $\pm 3\%$ or $\pm 0.3\text{pF}$ whichever is larger. X7R: within $\pm 12.5\%$ * Q/D.F value: NP0: $\text{Cap} \geq 30\text{pF}$: $\text{Q} \geq 350$ $10\text{pF} \leq \text{Cap} < 30\text{pF}$: $\text{Q} \geq 275 + 2.5\text{C}$ $\text{Cap} < 10\text{pF}$: $\text{Q} \geq 200 + 10\text{C}$ X7R: $\leq 3.0\%$ * I.R.: $\geq 1\text{G}\Omega$ or $\text{RxC} \geq 50\Omega\text{-F}$ whichever is smaller. |

Note:

* "Room condition" Temperature: 15 to 35°C , Relative humidity: 25 to 75%, Atmospheric pressure: 86 to 106kPa

RECOMMENDED PROFILE CONDITIONS

The lead-free termination MLCCs are not only to be used on SMT against lead-free solder paste, but also suitable against lead-containing solder paste. If the optimized solder joint is requested, increasing soldering time, temperature and concentration of N2 within oven are recommended.

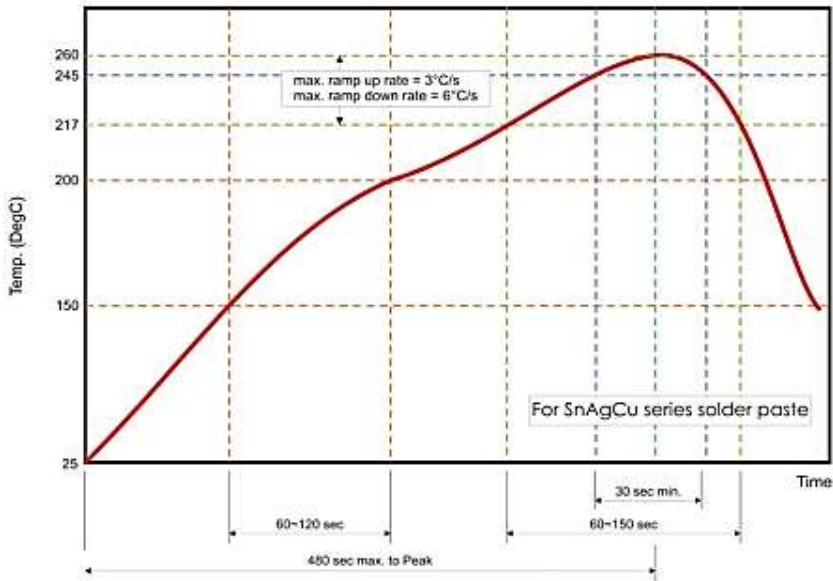

Reflow Soldering Profile For SMT Process with SnAgCu series Solder Paste



Wave Soldering Profile For SMT Process with SnAgCu series Solder Paste

STORAGE AND HANDLING CONDITIONS

- To prevent the damage of solderability of terminations, the following storage conditions are recommended:
Indoors under 5 ~ 40°C and 20% ~ 70% RH. related humidity conditions; MSL Level 1.
- The product is recommended to be used within one year after shipment. Check solderability in case of shelf life extension is needed.
- The corrosive gas reacts on the terminal electrodes of capacitors, and results in the poor solderability.
Do not store the capacitors in the ambience of corrosive gas (e.g., hydrogen sulfide, sulfur dioxide, chlorine, ammonia gas etc.)
- In corrosive atmosphere, solderability might be degraded, and silver migration might occur to cause low reliability.
- Due to the dewing by rapid humidity change, or the photochemical change of the terminal electrode by direct sunlight, the solderability and electrical performance may deteriorate. Do not store capacitors under direct sunlight or dewing condition. To store products on the shelf and avoid exposure to moisture.

TAPE DIMENSION (Unit: mm)

Paper Tape



Plastic Tape

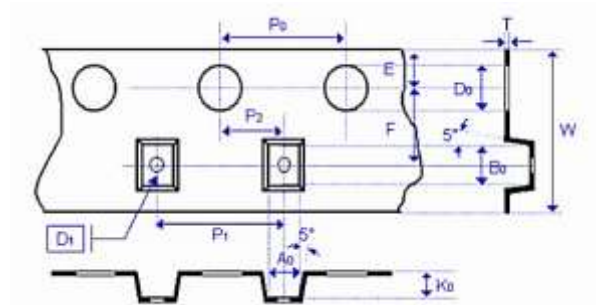

| SIZE | 0805 | | |
|-----------|-------------|--------------|--------------|
| Thickness | A,H | B,T | D,I |
| A0 | 1.50±0.20 | 1.50 ± 0.20 | < 1.80 |
| B0 | 2.30±0.20 | 2.30 ± 0.20 | < 2.70 |
| T | ≤1.15 | ≤1.20 | 0.23±0.1 |
| K0 | - | - | < 2.00 |
| W | 8.00±0.30 | 8.00 ± 0.30 | 8.00±0.30 |
| P0 | 4.00±0.10 | 4.00 ± 0.10 | 4.00±0.10 |
| 10xP0 | 40.00±0.20 | 40.00 ± 0.20 | 40.00 ± 0.20 |
| P1 | 4.00±0.10 | 4.00±0.10 | 4.00±0.10 |
| P2 | 2.00±-0.05 | 2.00±-0.05 | 2.00±0.05 |
| D0 | 1.50+0.1/-0 | 1.50+0.1/-0 | 1.50+0.1/-0 |
| D1 | - | - | 1.00+/-0.10 |
| E | 1.75±0.10 | 1.75±0.10 | 1.75±0.10 |
| F | 3.50±0.05 | 3.50±0.05 | 3.50±0.05 |

TAPE DIMENSION (Unit: mm)

| SIZE | 1206 | | | 1210 | | | |
|-------|-------------|-------------|-------------|-------------|-------------|-------------|-------------|
| | B,T | C,J,D | G,P | T | C,D | G,K | M |
| A0 | 1.90±0.50 | <2.00 | <2.30 | < 3.05 | < 3.05 | < 3.05 | < 3.20 |
| B0 | 3.50±0.50 | <3.70 | <4.00 | < 3.80 | < 3.80 | < 3.80 | < 4.00 |
| T | ≤1.20 | 0.23±0.1 | 0.23±0.1 | 0.23±0.1 | 0.23±0.1 | 0.23±0.1 | 0.23±0.1 |
| K0 | | <2.00 | <2.50 | <1.50 | <2.00 | <2.50 | <3.20 |
| W | 8.00±0.30 | 8.00±0.30 | 8.00±0.30 | 8.00±0.30 | 8.00±0.30 | 8.00±0.30 | 8.00±0.30 |
| P0 | 4.00±0.10 | 4.00±0.10 | 4.00±0.10 | 4.00±0.10 | 4.00±0.10 | 4.00±0.10 | 4.00±0.10 |
| 10xP0 | 40.0±0.20 | 40.0±0.20 | 40.0±0.20 | 40.0±0.20 | 40.0±0.20 | 40.0±0.20 | 40.0±0.20 |
| P1 | 4.00±0.10 | 4.00±0.10 | 4.00±0.10 | 4.00±0.10 | 4.00±0.10 | 4.00±0.10 | 4.00±0.10 |
| P2 | 2.00±0.05 | 2.00±0.05 | 2.00±0.05 | 2.00±0.05 | 2.00±0.05 | 2.00±0.05 | 2.00±0.05 |
| D0 | 1.50+0.1/-0 | 1.50+0.1/-0 | 1.50+0.1/-0 | 1.50+0.1/-0 | 1.50+0.1/-0 | 1.50+0.1/-0 | 1.50+0.1/-0 |
| D1 | | 1.00±0.10 | 1.00±0.10 | 1.00±0.10 | 1.00±0.10 | 1.00±0.10 | 1.00±0.10 |
| E | 1.75±0.10 | 1.75±0.10 | 1.75±0.10 | 1.75±0.10 | 1.75±0.10 | 1.75±0.10 | 1.75±0.10 |
| F | 3.50±0.05 | 3.50±0.05 | 3.50±0.05 | 3.50±0.05 | 3.50±0.05 | 3.50±0.05 | 3.50±0.05 |

TAPE DIMENSION (Unit: mm)

| SIZE | 1808 | | 1812 | | |
|-----------|-------------|-------------|-------------|-------------|-------------|
| | D,F | G,K | D,F | G,K | M,U |
| Thickness | | | | | |
| A0 | <2.50 | <2.50 | < 3.90 | < 3.90 | < 3.90 |
| B0 | <5.30 | <5.30 | < 5.30 | < 5.30 | < 5.30 |
| T | 0.25±0.1 | 0.25±0.1 | 0.25±0.1 | 0.25±0.1 | 0.25±0.1 |
| K0 | <2.00 | <2.50 | < 2.00 | < 2.50 | < 3.50 |
| W | 12.0±0.30 | 12.0±0.30 | 12.00±0.30 | 12.00±0.30 | 12.00±0.30 |
| P0 | 4.00±0.10 | 4.00±0.10 | 4.00±0.10 | 4.00±0.10 | 4.00±0.10 |
| 10xP0 | 40.0±0.20 | 40.0±0.20 | 40.00±0.20 | 40.00±0.20 | 40.00±0.20 |
| P1 | 4.00±0.10 | 4.00±0.10 | 8.00±0.10 | 8.00±0.10 | 8.00±0.10 |
| P2 | 2.00±0.10 | 2.00±0.10 | 2.00±0.10 | 2.00±0.10 | 2.00±0.10 |
| D0 | 1.50+0.1/-0 | 1.50+0.1/-0 | 1.50+0.1/-0 | 1.50+0.1/-0 | 1.50+0.1/-0 |
| D1 | 1.50±0.10 | 1.50±0.10 | 1.50±0.10 | 1.50±0.10 | 1.50±0.10 |
| E | 1.75±0.10 | 1.75±0.10 | 1.75±0.10 | 1.75±0.10 | 1.75±0.10 |
| F | 5.50±0.10 | 5.50±0.10 | 5.50±0.10 | 5.50±0.10 | 5.50±0.10 |

TAPE DIMENSION (Unit: mm)

| SIZE | 1825 | | 2220 | | 2225 | |
|-----------|--------------|--------------|--------------|--------------|--------------|--------------|
| Thickness | K | M, U | K | M, U | K | M, U |
| A0 | < 6.80 | < 6.80 | < 5.80 | < 5.80 | < 6.80 | < 6.80 |
| B0 | < 5.30 | < 5.30 | < 6.50 | < 6.50 | < 6.50 | < 6.50 |
| T | 0.30 +/-0.1 | 0.30 +/-0.1 | 0.30 +/-0.1 | 0.30 +/-0.1 | 0.30 +/-0.1 | 0.30 +/-0.1 |
| K0 | < 2.50 | < 3.50 | < 2.50 | < 3.50 | < 2.50 | < 3.50 |
| W | 12+/-0.30 | 12+/-0.30 | 12+/-0.30 | 12+/-0.30 | 12+/-0.30 | 12+/-0.30 |
| P0 | 4.00 +/-0.10 | 4.00 +/-0.10 | 4.00 +/-0.10 | 4.00 +/-0.10 | 4.00 +/-0.10 | 4.00 +/-0.10 |
| 10xP0 | 40.0 +/-0.20 | 40.0 +/-0.20 | 40.0 +/-0.20 | 40.0 +/-0.20 | 40.0 +/-0.20 | 40.0 +/-0.20 |
| P1 | 8.00 +/-0.10 | 8.00 +/-0.10 | 8.00 +/-0.10 | 8.00 +/-0.10 | 8.00 +/-0.10 | 8.00 +/-0.10 |
| P2 | 2.00 +/-0.10 | 2.00 +/-0.10 | 2.00 +/-0.10 | 2.00 +/-0.10 | 2.00 +/-0.10 | 2.00 +/-0.10 |
| D0 | 1.50 +0.1/-0 | 1.50 +0.1/-0 | 1.50 +0.1/-0 | 1.50 +0.1/-0 | 1.50 +0.1/-0 | 1.50 +0.1/-0 |
| D1 | 1.50 +/-0.10 | 1.50 +/-0.10 | 1.50 +/-0.10 | 1.50 +/-0.10 | 1.50 +/-0.10 | 1.50 +/-0.10 |
| E | 1.75 +/-0.10 | 1.75 +/-0.10 | 1.75 +/-0.10 | 1.75 +/-0.10 | 1.75 +/-0.10 | 1.75 +/-0.10 |
| F | 5.50 +/-0.10 | 5.50 +/-0.10 | 5.50 +/-0.10 | 5.50 +/-0.10 | 5.50 +/-0.10 | 5.50 +/-0.10 |

REEL DIMENSION (Unit: mm)

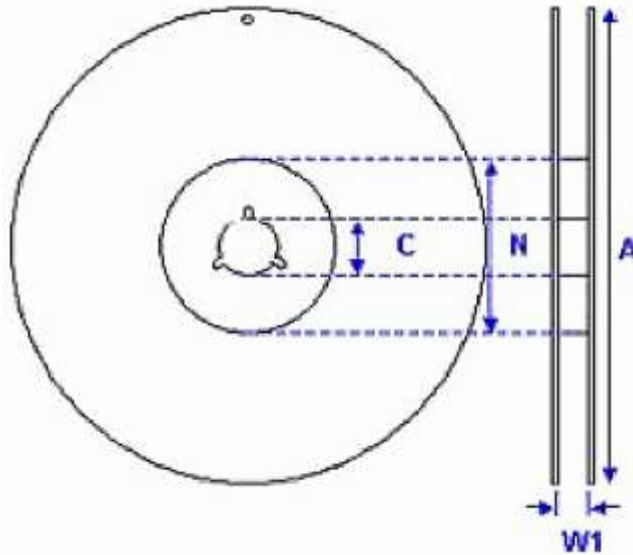

| SIZE CODE | 0805, 1206, 1210 | | | 1808, 1812, 1825, 2220, 2225 |
|-----------|------------------|-----------|-----------|------------------------------|
| Reel Size | 7" | 10" | 13" | 7" |
| C | 13.0±0.5 | 13.0±0.5 | 13.0±0.5 | 13.0±0.5 |
| W 1 | 10.0±1.5 | 10.0±1.5 | 10.0±1.5 | 12.4+2.0/-0 |
| A | 178.0±2.0 | 250.0±2.0 | 330.0±2.0 | 178.0±2.0 |
| N | 60.0+1.0/-0 | 50 min | 50 min | 60.0+1.0/-0 |

PEELING FORCE (EIA-481)

- Peel-off force should be in the range of 10 grams to 100 grams at a peel-off speed of 300±10 mm/min.

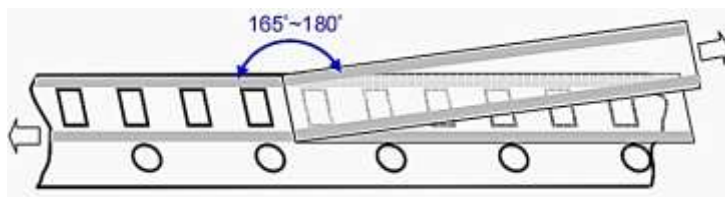

PACKAGING STYLE AND QUANTITY PER REEL

| SIZE | THICKNESS (SYMBOL) | | PAPER TAPE | | PLASTIC TAPE | |
|-------------------------------------------|--------------------|---|------------|----------|--------------|----------|
| | | | 7" REEL | 13" REEL | 7" REEL | 13" REEL |
| 0805 (2012) | 0.60±0.10 | A | 4,000 | 15,000 | - | - |
| | 0.80±0.10 | B | 4,000 | 15,000 | - | - |
| | 1.25±0.10 | D | - | - | 3000 | 10,000 |
| | 1.25±0.20 | I | - | - | 3000 | 10,000 |
| 1206 (3216) | 0.80±0.10 | B | 4,000 | 15,000 | - | - |
| | 0.95±0.10 | C | - | - | 3,000 | 10,000 |
| | 1.25±0.10 | D | - | - | 3,000 | 10,000 |
| | 1.60±0.20 | G | - | - | 2,000 | 10,000 |
| | 1.60+0.30/-0.10 | P | - | - | 2,000 | 9,000 |
| 1210 (3225) | 0.95±0.10 | C | - | - | 3,000 | 10,000 |
| | 1.25±0.10 | D | - | - | 3,000 | 10,000 |
| | 1.60±0.20 | G | - | - | 2,000 | - |
| | 2.00±0.20 | K | - | - | 1,000 | 6,000 |
| | 2.50±0.30 | M | - | - | 1,000 | 6,000 |
| 1808 (4520) | 1.25±0.10 | D | | | 2,000 | 10,000 |
| | 1.60±0.20 | G | | | 2,000 | 8,000 |
| | 2.00±0.20 | K | | | 1,000 | 6,000 |
| 1812 (4532) | 1.25±0.10 | D | | | 1,000 | 5,000 |
| | 1.60±0.20 | G | | | 1,000 | - |
| | 2.00±0.20 | K | | | 1,000 | - |
| | 2.50±0.30 | M | | | 500 | 3,000 |
| 1825 (4563) 2220 (5750) 2225 (5763) | 2.00±0.20 | K | - | - | 1,000 | - |
| | 2.50±0.30 | M | - | - | 500 | - |
| | 2.80±0.30 | U | - | - | 500 | - |

IMPORTANT NOTES AND DISCLAIMER

1. **ROHS COMPLIANCE:** The levels of RoHS restricted materials in this product are below the maximum concentration values (also referred to as the threshold limits) permitted for such substances, or are used in an exempted application, in accordance with EU RoHS Directive (EU) 2015/863 EC (RoHS3). RoHS Test Report for this product can be obtained at Download Center.
2. **REACH COMPLIANCE:** REACH substances of high concern (SVHCs) information is available for this product. Since the European Chemical Agency (ECHA) has published notice of their intent to frequently revise the SVHC listing for the foreseeable future, REACH Test Report for this product can be obtained at Download Center.
3. All Product parametric performance is indicated in the Electrical Characteristics for the listed herein test conditions, unless otherwise noted. Product performance may not be indicated by the Electrical Characteristics if operated under different conditions.
4. NextGen Component, Inc (*NextGen*) reserves the right to make changes to this document and its products and specifications at any time without notice. Customers should obtain and confirm the latest product information and specifications before final design, purchase or use.
5. *NextGen* makes no warranty, representation or guarantee regarding the suitability of its products for any particular purpose, not does *NextGen* assume any liability for application assistance or customer product design.
6. *NextGen* does not warrant or accept any liability with products which are purchased or used for any unintended or unauthorized application. No license is granted by implication or otherwise under any intellectual property rights of NextGen.
7. *NextGen* products are not authorized for use as critical components in life support devices or systems without express written approval by *NextGen*.
8. *NextGen* requires that customers first obtain an RMA (Returned Merchandise Authorization) number prior to returning any products. Returns must be made within 30 days of the date of invoice, be in the original packaging, unused and like-new condition. At the time of quoting or purchasing, a product may say that it is Non-Cancelable/ Non-Returnable (NCNR). These products are not returnable and not refundable.