



<b>SPECIFICATION SHEET NO.</b>	R1203- 1812B332K202KA	
<b>ORIGINAL MFG/PART NO.</b>	Aillen Capacitors/1812B332K202KA-G	
<b>NEXTGEN PART CODE</b>	1812B332K202KA	Indicate This Code For <a href="#">RFQ/Order</a>
<b>DATE</b>	Dec. 3, 2024	
<b>REVISION</b>	A7	Updated With Most Recent Data
<b>DESCRIPTION AND MAIN PARAMETRICS</b>	<p>High Voltage Multilayer Ceramic Chip Capacitors (MLCC), G Type, 1812 Series            Case 4532 Metric 1812, Dimension L4.50*W3.20*H2.00mm            Thickness: 2.20mm Max. Dielectric X7R, Capacitance 3300pF, Tolerance ±10%            Rated Voltage 2000V            Operating Temp. Range -55°C ~+125°C            Package in Tape/Reel, 1,000pcs/Reel            REACH/RoHS/RoHS III Compliant</p>	
<b>CUSTOMER</b>		
<b>CUSTOMER PART NUMBER</b>		
<b>CROSS REF. PART NUMBER</b>		
<b>MEMO</b>		

<b>VENDOR APPROVE</b>		
Issued/Checked/Approved		
		
Effective Date: Dec. 3, 2024		

<b>CUSTOMER APPROVE</b>
Date:

## DESCRIPTION

High voltage series MLCC is designed by a special internal electrode pattern, which can reduce voltage concentrations by distributing voltage gradients throughout the entire capacitor. This special design also affords increased capacitance values in a given case size and voltage rate. Capacitors with X7R dielectrics are not intended for AC line filtering applications. Capacitors may require protective surface coating to prevent external arcing.



*Image shown is a representation only.*

*Exact specifications should be obtained from the product dimension.*

## MAIN FEATURE

- A Wide Selection Of Size Is Available
- High Capacitance and High Voltage 1000V~4000V
- High Reliability And Stability
- Temperature Characteristics: NPO (COG) and X7R
- Capacitor With Lead-free Termination
- REACH/RoHS/RoHS III Compliant



## APPLICATION

- Snubbers In High Frequency Power Converters.
- High Voltage Coupling/DC Blocking.
- DC-DC Converters.
- Back-lighting Inverters

## ELECTRICAL CHARACTERISTICS

- See Page 4 ~Page 7 For Different Part Code And Rated Voltage.
- All Products Parameters are Subject To NextGen Components' Final Confirmation.

**HOW TO ORDER**

- Please Follow Up Part Code Guide And Indicate NextGen Part Code 1812B332K202KA For RFQ and Order.

**RFQ**

[Request For Quotation](#)

**PART CODE GUIDE**

CODE	NAME	KEY SPECIFICATION OPTION
1812	Case Size	0805 (2012 Metric): L2.00*W1.25mm; 1206 (3216 Metric): L3.20*W1.60mm 1210 (3225 Metric): L3.20*W2.50mm; 1808 (4520 Metric): L4.50*W2.03mm 1812 (4532 Metric): L4.50*W3.20mm; 1825 (4563 Metric):L4.50*W6.30mm 2220 (5750 Metric): L5.70*W5.00mm; 2225 (5763 Metric ): L5.70*W6.30mm
B	Temperature Coefficient	N: NPO (COG); B: X7R
332	Capacitance	Two significant digits followed by number of Zero, The 3rd digit signifies the multiplying factor, and letter R is decimal point. 0R5: 0.5pF; 102: 1000pF; 332: 3300pF; 102: 1000pF; 821: 820pF; 103: 0.01μF
K	Tolerance	B: ±0.1pF; C: ±0.25pF; D: ±0.5pF; F: ±1%; G: ±2%; J: ±5%; K: ±10% M: ±20%
202	Rated Voltage	102: 1000 VDC; 152: 1500 VDC; 202: 2000 VDC; 252: 2500 VDC 302: 3000 VDC; 402: 4000 VDC
K	Thickness	K: 2.00 ± 0.20mm, See Page 8 ~ Page 9 ( T's Symbol ) for Different part code
A	Package	K: 0.5 Kpcs/Reel; A: 1Kpcs/Reel; B: 2Kpcs/Reel; C: 3Kpcs/Reel; D: 4Kpcs/Reel; E: 15Kpcs/Reel; I: 10Kpcs/Reel; J: 2.5Kpcs/Reel
( )	Internal Control	Blank: N/A; XX: Letter A~Z, a~z or digits (0~9) for Special/Custom Parameters

**ELECTRICAL CHARACTERISTICS** - 1000V NP0 (COG) & X7R FOR DIFFERENT PART CODE

NEXTGEN PART CODE	TEMP. COEFFICIENT	CAPACITANCE	TOLERANCE	VOLTAGE	THICKNESS (MAX.)	OPERATING TEMP. RANGE	CAPACITANCE CHARACTERISTIC
	-	-	-	V	mm	°C	-
0805B102K102BD	X7R	1000 pF	±10%	1000	0.90	-55 ~ 125	±15%
1206B102K102DC	X7R	1000 pF	±10%	1000	1.35	-55 ~ 125	±15%
1206B103K102DC	X7R	0.01 µF	±10%	1000	1.35	-55 ~ 125	±15%
1206B151K102DC	X7R	150 pF	±10%	1000	1.35	-55 ~ 125	±15%
1206B152K102DC	X7R	1500pF	±10%	1000	1.35	-55 ~ 125	±15%
1206B221K102BD	X7R	220 pF	±10%	1000	0.90	-55 ~ 125	±15%
1206B222K102DC	X7R	2200 pF	±10%	1000	1.35	-55 ~ 125	±15%
1206B331K102DC	X7R	330 pF	±10%	1000	1.35	-55 ~ 125	±15%
1206B332K102DC	X7R	3300 pF	±10%	1000	1.35	-55 ~ 125	±15%
1206B471K102DC	X7R	470 pF	±10%	1000	1.35	-55 ~ 125	±15%
1206B681K102DC	X7R	680 pF	±10%	1000	1.35	-55 ~ 125	±15%
1206B682K102DC	X7R	6800 pF	±10%	1000	1.35	-55 ~ 125	±15%
1206B821K102DC	X7R	820 pF	±10%	1000	1.35	-55 ~ 125	±15%
1812B103K102DA	X7R	0.01 µF	±10%	1000	1.35	-55 ~ 125	±15%
0805N330J102DC	NP0 (COG)	33 pF	±5%	1000	1.35	-55 ~ 125	±30ppm
1206N100J102CC	NP0 (COG)	10 pF	±5%	1000	1.05	-55 ~ 125	±30ppm
1206N101J102BD	NP0 (COG)	100 pF	±5%	1000	0.90	-55 ~ 125	±30ppm
1206N151J102DC	NP0 (COG)	150 pF	±5%	1000	1.35	-55 ~ 125	±30ppm
1206N220J102BD	NP0 (COG)	22 pF	±5%	1000	0.90	-55 ~ 125	±30ppm
1206N221J102DC	NP0 (COG)	220 pF	±5%	1000	1.35	-55 ~ 125	±30ppm

**ELECTRICAL CHARACTERISTICS** - 1000V NP0 (COG) & X7R FOR DIFFERENT PART CODE

NEXTGEN PART CODE	TEMP. COEFFICIENT	CAPACITANCE	TOLERANCE	VOLTAGE	THICKNESS (MAX.)	OPERATING TEMP. RANGE	CAPACITANCE CHARACTERISTIC
	-	-	-	V	mm	°C	-
1206N221J102GB	NP0 (COG)	220 pF	±5%	1000	1.80	-55 ~ 125	±30ppm
1206N330J102BD	NP0 (COG)	33 pF	±5%	1000	0.90	-55 ~ 125	±30ppm
1206N331J102GB	NP0 (COG)	330 pF	±5%	1000	1.80	-55 ~ 125	±30ppm
1206N470J102BC	NP0 (COG)	47 pF	±5%	1000	0.90	-55 ~ 125	±30ppm
1206N470J102CC	NP0 (COG)	47 pF	±5%	1000	1.05	-55 ~ 125	±30ppm
1206N471J102GB	NP0 (COG)	470 pF	±5%	1000	1.80	-55 ~ 125	±30ppm
1206N560J102CC	NP0 (COG)	56 pF	±5%	1000	1.05	-55 ~ 125	±30ppm
1206N5R0C102BD	NP0 (COG)	5 pF	±0.25pF	1000	0.90	-55 ~ 125	±30ppm
1206N680J102CC	NP0 (COG)	68 pF	±5%	1000	1.05	-55 ~ 125	±30ppm
1206N681J102GB	NP0 (COG)	680 pF	±5%	1000	1.80	-55 ~ 125	±30ppm
1210B103K102GB	X7R	0.01 μF	±10%	1000	1.80	-55 ~ 125	±15%
1808N102J102KA	NP0 (COG)	1000 pF	±5%	1000	2.20	-55 ~ 125	±30ppm
1812B104K102MK	X7R	0.1 μF	±10%	1000	2.80	-55 ~ 125	±15%
1812B222K102DA	X7R	2200 pF	±10%	1000	1.35	-55 ~ 125	±15%
1812B102K102DA	X7R	1000 pF	±10%	1000	1.35	-55 ~ 125	±15%
1812B103K102DA	X7R	0.01 μF	±10%	1000	1.35	-55 ~ 125	±15%
1812N471J102KA	NP0 (COG)	470 pF	±5%	1000	2.20	-55 ~ 125	±30ppm
1812N471K102KA	NP0 (COG)	470 pF	±10%	1000	2.20	-55 ~ 125	±30ppm

**ELECTRICAL CHARACTERISTICS** - 2000V NP0 (COG) & X7R FOR DIFFERENT PART CODE

NEXTGEN PART CODE	TEMP. COEFFICIENT	CAPACITANCE	TOLERANCE	VOLTAGE	THICKNESS (MAX.)	OPERATING TEMP. RANGE	CAPACITANCE CHARACTERISTIC
	-	-	-	V	mm	°C	-
1206B102K202BD	X7R	1000 pF	±10%	2000	0.90	-55 ~ 125	±15%
1206B102K202DC	X7R	1000 pF	±10%	2000	1.35	-55 ~ 125	±15%
1206B222K202GB	X7R	2200 pF	±10%	2000	1.80	-55 ~ 125	±15%
1206B471K202DC	X7R	470 pF	±10%	2000	1.35	-55 ~ 125	±15%
1206N101J202DC	NP0 (COG)	100 pF	±5%	2000	1.35	-55 ~ 125	±30ppm
1206N330J202CC	NP0 (COG)	33 pF	±5%	2000	1.05	-55 ~ 125	±30ppm
1210B102K202DC	X7R	1000 pF	±10%	2000	1.35	-55 ~ 125	±15%
1210B152K202MA	X7R	1500 pF	±10%	2000	2.80	-55 ~ 125	±15%
1808B222K202KA	X7R	2200 pF	±10%	2000	2.20	-55 ~ 125	±15%
1812B102K202DA	X7R	1000 pF	±10%	2000	1.35	-55 ~ 125	±15%
1812B103K202MK	X7R	0.01 μF	±10%	2000	2.80	-55 ~ 125	±15%
1812B222K202DA	X7R	2200 pF	±10%	2000	1.35	-55 ~ 125	±15%
<b>1812B332K202KA</b>	X7R	3300 pF	±10%	2000	2.20	-55 ~ 125	±15%
1812B472K202KA	X7R	4700 pF	±10%	2000	2.20	-55 ~ 125	±15%
1812N101J202DA	NP0 (COG)	100 pF	±5%	2000	1.35	-55 ~ 125	±30ppm
1812N221J202DA	NP0 (COG)	220 pF	±5%	2000	1.35	-55 ~ 125	±30ppm

**ELECTRICAL CHARACTERISTICS** - 3000V NP0 (COG) & X7R FOR DIFFERENT PART CODE

NEXTGEN PART CODE	TEMP. COEFFICIENT	CAPACITANCE	TOLERANCE	VOLTAGE	THICKNESS (MAX.)	OPERATING TEMP. RANGE	CAPACITANCE CHARACTERISTIC
	-	-	-	V	mm	°C	-
1808N330J302DB	NP0 (COG)	33 pF	±5%	3000	1.35	-55 ~ 125	±30ppm
1812B102K302KA	X7R	1000 pF	±10%	3000	2.20	-55 ~ 125	±15%
1812N101K302DA	NP0 (COG)	100 pF	±10%	3000	1.35	-55 ~ 125	±30ppm

**DIMENSION** (Unit: mm)

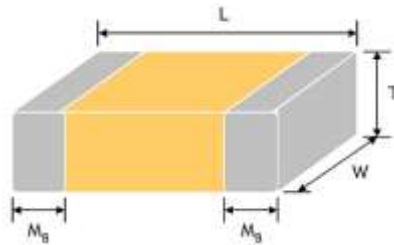

SIZE CODE	METRIC CODE	L	W	T (SYMBOL )		REMARK	MB
0805	2012	2.00 ±0.15	1.25 ±0.10	0.60±0.10	A		0.50±0.20
				0.80±0.10	B		
				1.25 ±0.10	D	#	
		2.00 ±0.20	1.25 ±0.20	1.25 ±0.20	I	#	
1206	3216	3.20 ±0.15	1.60 ±0.15	0.80±0.10	B		0.60±0.20 (0.50±0.25)*
				0.95±0.10	C	#	
				1.25±0.10	D	#	
		3.20 ±0. 20	1.60 ±0.20	1.60±0.20	G	#	
		3.20 +0. 3/-0.1	1.60+0.3/-0.1	1.60+0.3/-0.1	P	#	
1210	3225	3.20 ±0.30	2.50 ±0.20	0.95±0.10	C	#	0.75±0.25
				1.25±0.10	D	#	
		3.20 ±0.40	2.50 ±0.30	1.60±0.20	G	#	
				2.00±0.20	K	#	
				2.50±0.30	M	#	
		3.20 ±0.60	2.50 ±0.50	2.50±0.50	M	#	
1808	4520	4.50+0.5/-0.3	2.03±0.25	1.25±0.10	D	#	0.50±0.25
				1.60±0.20	G	#	
				2.00±0.20	K	#	



**DIMENSION** (Unit: mm)

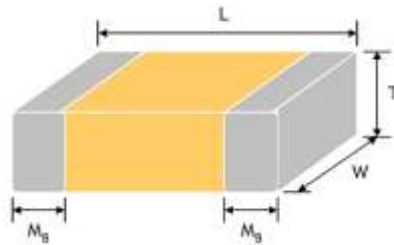

SIZE CODE	METRIC CODE	L	W	T (SYMBOL )		REMARK	MB
1812	4532	4.50+0.5/-0.3	3.20±0.30	1.25±0.10	D	#	0.50±0.25
				1.60±0.20	G	#	
				2.00±0.20	K	#	
		4.50+0.5/-0.3	3.20±0.40	2.50±0.30	M	#	
				2.80±0.30	U	#	
1825	4563	4.50±0.40	6.30±0.40	2.00±0.20	K	#	0.75±0.35
				2.50±0.30	M	#	
				2.80±0.30	U	#	
2220	5750	5.70±0.40	5.00±0.40	2.00±0.20	K	#	0.85±0.35
				2.50±0.30	M	#	
				2.80±0.30	U	#	
2225	5763	5.70±0.40	6.30±0.40	2.00±0.20	K	#	0.85±0.35
				2.50±0.30	M	#	
				2.80±0.30	U	#	

Note: 1) # Reflow soldering only is recommended. 2) \* For 1206 ≥ 1000V ~ 3000V products.

**CONSTRUCTIONS**



NO.	NAME		NPO	X7R
1	Ceramic Material		CaZrO based	BaTiO based
2	Inner Electrode		Ni	
3	Termination	Inner Electrode	Cu	
4		Middle Layer	Ni	
5		Outer Layer	Sn	

**GENERAL ELECTRONICAL CHARACTERISTICS**

DIELECTRIC	NPO	X7R
Size	0805, 1206, 1210, 1808, 1812, 1825, 2220, 2225	
Capacitance range*	0.1pF to 0.1μF	100pF to 22μF
Capacitance Tolerance***	Cap≤5pF: C (±0.25pF) 5pF<Cap<10pF: D (±0.5pF) Cap≥10pF: F (±1%), G (±2%), J (±5%),K (±10%)	J (±5%) #1 K (±10%), M (±20%)
Rated Voltage (WVDC)	1000V to 4000V	
Q/DF (Tan δ) *	Cap<30pF: Q≥400+20C Cap≥30pF: Q≥1000	Cap<4.7μF: ≤2.5% Cap≥4.7μF: ≤3.5%
Insulation resistance at Ur**	Ur=1000~3000V: ≥10GΩ	
Dielectric strength	1000~3000V: ≥1.2 x WVDC 4000: ≥1.1 x WVDC	
Operating Temperature	-55 ~+125°C	
Capacitance Characteristic	±30ppm	±15%
Termination	Ni/Sn (lead-free termination)	

**Note:**

- #1: X7R products can provide optional J (±5%) capacitance tolerance.
- \* Measured at the condition of 30~70% related humidity.
- NPO: Apply 1.0±0.2Vrms, 1.0MHz±10% for Cap≤1000pF and 1.0±0.2Vrms, 1.0kHz±10% for Cap>1000pF, 25°C at ambient temperature.
- X7R, X5R: Apply 1.0±0.2Vrms, 1.0kHz±10%, at 25°C ambient temperature.
- \*\* Preconditioning for Class II MLCC: Perform a heat treatment at 150±10°C for 1 hour, then leave in a ambient condition for 24±2 hours

**CAPACITANCE RANGE - NP0 (COG) DIELECTRIC - SIZE 0805, 1206,1210**

Table 1-A

SIZE	0805	1206			1210		
VDC (V)	1000	1000	1500	2000	1000	1500	2000
0.5pF (0R5)	D						
1.0pF (1R0)	D						
1.2pF (1R2)	D						
1.5pF (1R5)	D	B	B	B			
1.8pF (1R8)	D	B	B	B			
2.0pF (2R0)	D	B	B	B			
2.2pF (2R2)	D	B	B	B			
2.7pF (2R7)	D	B	B	B			
3.3pF (3R3)	D	B	B	B			
3.9pF (3R9)	D	B	B	B			
4.7pF (4R7)	D	B	B	B			
5.6pF (5R6)	D	B	B	B			
6.8pF (6R8)	D	B	B	B			
8.2pF (8R2)	D	B	B	B			
10pF (100)	D	B	B	B	C	C	C
12pF (120)	D	B	B	B	C	C	C
15pF (150)	D	B	B	B	C	C	C
18pF (180)	D	B	B	B	C	C	C
22pF (220)	D	B	B	B	C	C	C
27pF (270)	D	B	B	B	C	C	C
33pF (330)	D	B	C	C	C	C	C
39pF (390)	D	B	C	C	C	C	C
47pF (470)	D	B	C	C	C	C	C
56pF (560)	D	B	D	D	C	D	D
68pF (680)	D	B	D	D	C	D	D
82pF (820)	D	B	D	D	C	D	D
100pF (101)	D	B	D	D	D	D	D
120pF (121)	D	D	G	G	D	D	D
150pF (151)	D	D	G	G	D	G	G
180pF (181)	D	G	G	G	D	G	G

**CAPACITANCE RANGE** - NP0 (COG) DIELECTRIC - SIZE 0805, 1206, 1210

Table 1-B

SIZE	0805	1206			1210		
		1000	1500	2000	1000	1500	2000
VDC (V)	1000	1000	1500	2000	1000	1500	2000
220pF (221)	D	G	G	G	G	G	G
270pF (271)	D	G	P	P	G	K	K
330pF (331)	D	G	P	P	G	K	K
390pF (391)	D	G	P	P	G	M	M
470pF (471)		G			G	M	M
560pF (561)		G			G		
680pF (681)		G			G		
820pF (821)		G			G		
1,000pF (102)		G			G		
1,200pF (122)		G			K		
1,500pF (152)		G			K		
1,800pF (182)		G			K		
2,200pF (222)		G			K		
2,700pF (272)		G			K		
3,300pF (332)		G			K		
3,900pF (392)		G			K		
4,700pF (472)		G			K		
5,600pF (562)					K		
6,800pF (682)					K		
8,200pF (822)					K		
0.010μF (103)					M		
0.012μF (123)					M		
0.015μF (153)					M		
0.018μF (183)					M		
0.022μF (223)					M		

**CAPACITANCE RANGE - NP0 (COG) DIELECTRIC - SIZE 1808, 1812**

Table 1-C

Size	1808					1812					
	VDC (V)	1000	1500	2000	3000	4000	1000	1500	2000	3000	4000
2.0pF (2R0)	D	D	D	D							
2.2pF (2R2)	D	D	D	D							
2.7pF (2R7)	D	D	D	D							
3.3pF (3R3)	D	D	D	D							
3.9pF (3R9)	D	D	D	D							
4.7pF (4R7)	D	D	D	D							
5.6pF (5R6)	D	D	D	D							
6.8pF (6R8)	D	D	D	D							
8.2pF (8R2)	D	D	D	D							
10pF (100)	D	D	D	D	D	D	D	D	D	D	D
12pF (120)	D	D	D	D	D	D	D	D	D	D	D
15pF (150)	D	D	D	D	D	D	D	D	D	D	D
18pF (180)	D	D	D	D	D	D	D	D	D	D	D
22pF (220)	D	D	D	D	G	D	D	D	D	D	D
27pF (270)	D	D	D	D	G	D	D	D	D	D	D
33pF (330)	D	D	D	D		D	D	D	D		
39pF (390)	D	D	D	D		D	D	D	D		
47pF (470)	D	D	D	D		D	D	D	D		
56pF (560)	D	D	D	D		D	D	D	D		
68pF (680)	D	D	D	D		D	D	D	D		
82pF (820)	D	D	D	D		D	D	D	D		
100pF (101)	D	D	D	K		D	D	D	D		
120pF (121)	D	D	D	K		D	D	D	D		
150pF (151)	D	K	K	K		D	D	D	D		
180pF (181)	D	K	K	K		D	D	D	K		
220pF (221)	D	K	K	K		D	D	D	K		
270pF (271)	K	K	K	K		D	K	K	K		
330pF (331)	K	K	K	K		D	K	K	K		
390pF (391)	K	K	K	K		D	K	K	K		
470pF (471)	K	K	K			K	K	K	K		

**CAPACITANCE RANGE - NP0 (COG) DIELECTRIC - SIZE 1808, 1812**

Table 1-D

SIZE	1808					1812					
	VDC (V)	1000	1500	2000	3000	4000	1000	1500	2000	3000	4000
560pF (561)	K	K	K				K	K	K		
680pF (681)	K	K	K				K	K	K		
820pF (821)	K	D	D				K	K	K		
1,000pF (102)	K	G	G				K	K	K		
1,200pF (122)	G	G	G				K				
1,500pF (152)	K	K	K				K				
1,800pF (182)	K	K	K				K				
2,200pF (222)	K	K	K				K				
2,700pF (272)	K						K				
3,300pF (332)	K						K				
3,900pF (392)							M				
4,700pF (472)							M				
5,600pF (562)							M				

**CAPACITANCE RANGE - NP0 (COG) DIELECTRIC - SIZE 1825, 2220**

Table 1-E

SIZE	1825				2220				
	VDC (V)	1000	2000	3000	4000	1000	2000	3000	4000
10pF (100)	K	K	K	K	K	K	K	K	K
12pF (120)	K	K	K	K	K	K	K	K	K
15pF (150)	K	K	K	K	K	K	K	K	K
18pF (180)	K	K	K	K	K	K	K	K	K
22pF (220)	K	K	K	K	K	K	K	K	K
27pF (270)	K	K	K	K	K	K	K	K	K
33pF (330)	K	K	K	K	K	K	K	K	K
39pF (390)	K	K	K	K	K	K	K	K	K
47pF (470)	K	K	K	K	K	K	K	K	K
56pF (560)	K	K	K	K	K	K	K	K	K
68pF (680)	K	K	K	K	K	K	K	K	K
82pF (820)	K	K	K	K	K	K	K	K	K
100pF (101)	K	K	K	K	K	K	K	K	K
120pF (121)	K	K	K		K	K	K		
150pF (151)	K	K	K		K	K	K		
180pF (181)	K	K	K		K	K	K		
220pF (221)	K	K	K		K	K	K		
270pF (271)	K	K	K		K	K	M		
330pF (331)	K	K	K		K	K	M		
390pF (391)	K	K	K		K	K	M		
470pF (471)	K	K	K		K	K	M		
560pF (561)	K	K	K		K	K	M		
680pF (681)	K	K	M		K	K	M		
820pF (821)	K	K	M		K	K	M		
1,000pF (102)	K	K	M		K	K	M		
1,200pF (122)	K	K			M	M	M		
1,500pF (152)	K	M			M	M	M		
1,800pF (182)	K	M			M	M			
2,200pF (222)	K	M			M	M			
2,700pF (272)	K	M			M	M			





**CAPACITANCE RANGE - NP0 (COG) DIELECTRIC - SIZE 2225**

Table 1-G

SIZE	2225			
	1000	2000	3000	4000
VDC (V)				
10pF (100)	K	K	K	K
12pF (120)	K	K	K	K
15pF (150)	K	K	K	K
18pF (180)	K	K	K	K
22pF (220)	K	K	K	K
27pF (270)	K	K	K	K
33pF (330)	K	K	K	K
39pF (390)	K	K	K	K
47pF (470)	K	K	K	K
56pF (560)	K	K	K	K
68pF (680)	K	K	K	K
82pF (820)	K	K	K	K
100pF (101)	K	K	K	K
120pF (121)	K	K	K	
150pF (151)	K	K	K	
180pF (181)	K	K	K	
220pF (221)	K	K	K	
270pF (271)	K	K	K	
330pF (331)	K	K	K	
390pF (391)	K	K	K	
470pF (471)	K	K	K	
560pF (561)	K	K	K	
680pF (681)	K	K	K	
820pF (821)	K	M	M	
1,000pF (102)	K	M	M	
1,200pF (122)	K	M		
1,500pF (152)	K	M		
1,800pF (182)	K	M		
2,200pF (222)	K	M		
2,700pF (272)	K	M		



**CAPACITANCE RANGE** – X7R DIELECTRIC - SIZE 805, 1206,1210

Table 2-A

SIZE	0805	1206				1210		
VDC (V)	1000	1000	1500	2000	2500	1000	1500	2000
100pF (101)	B	D	D	D	D	D	D	D
120pF (121)	B	D	D	D	D	D	D	D
150pF (151)	B	D	D	D	D	D	D	D
180pF (181)	B	D	D	D	D	D	D	D
220pF (221)	B	B	D	B	D	D	D	D
270pF (271)	B	D	D	D	D	D	D	D
330pF (331)	B	D	D	D	D	D	D	D
390pF (391)	B	D	D	D	D	D	D	D
470pF (471)	B	D	D	D	D	D	D	D
560pF (561)	B	D	D	D	D	D	D	D
680pF (681)	B	D	D	D	D	D	D	D
820pF (821)	B	D	D	D	D	D	D	D
1,000pF (102)	B	D	D	D	D	D	D	D
1,200pF (122)	B	D	G	G	G	D	M	M
1,500pF (152)	D	D	G	G	G	D	M	M
1,800pF (182)	D	D	G	G	G	D	M	M
2,200pF (222)	D	D	G	G	G	D	M	M
2,700pF (272)	D	D	G	G		D	M	M
3,300pF (332)	D	D	G	G		D	M	M
3,900pF (392)	D	D	G			G	M	M
4,700pF (472)	D	D	G			G	M	M
5,600pF (562)	D	D	G			G	M	M
6,800pF (682)	D	D	G			G	M	M
8,200pF (822)	D	D	G			G	M	M
0.010µF (103)	D	D	G			G	M	
0.012µF (123)		G				G		
0.015µF (153)		G				G		
0.018µF (183)						G		
0.033µF (333)						G		
0.039µF (393)						K		
0.047µF (473)						M		

**CAPACITANCE RANGE – X7R DIELECTRIC - SIZE 1808, 1812**

Table 2-B

Size	1808					1812				
VDC (V)	1000	1500	2000	3000	4000	1000	1500	2000	3000	4000
150pF (151)	D	D	D	D	K					
180pF (181)	D	D	D	D	K					
220pF (221)	D	D	D	D	K					
270pF (271)	D	D	D	D	K	D	D	D	K	K
330pF (331)	D	D	D	K	K	D	D	D	K	K
390pF (391)	D	D	D	K	K	D	D	D	K	K
470pF (471)	D	D	D	K	K	D	D	D	K	K
560pF (561)	D	D	D	K	K	D	D	D	K	K
680pF (681)	D	D	D	K	K	D	D	D	K	K
820pF (821)	D	D	D	K	K	D	D	D	K	K
1,000pF (102)	D	K	K	K	K	D	D	D	K	K
1,200pF (122)	D	K	K	K		D	D	D	K	M
1,500pF (152)	D	K	K	K		D	D	D	K	M
1,800pF (182)	D	K	K	K		D	D	D	M	M
2,200pF (222)	D	K	K	K		D	D	D	M	
2,700pF (272)	D	K	K	K		D	D	D	M	
3,300pF (332)	D	K	K	K		D	K	K	M	
3,900pF (392)	D	K	K			D	K	K	M	
4,700pF (472)	D	K	K			D	K	K	M	
5,600pF (562)	K	K	K			D	M	M	M	
6,800pF (682)	K	K	K			D	M	M	M	
8,200pF (822)	K	K	K			D	M	M		
0.010μF (103)	K	K	K			D	M	M		
0.012μF (123)	K					K	M	M		
0.015μF (153)	K					K	M	M		
0.018μF (183)	K					M	M	M		

**CAPACITANCE RANGE** – X7R DIELECTRIC - SIZE 1808, 1812

Table 2-C

Size	1808					1812					
	VDC (V)	1000	1500	2000	3000	4000	1000	1500	2000	3000	4000
0.022μF (223)							M	M	M		
0.033μF (333)	K						M				
0.039μF (393)	K						M				
0.047μF (473)	K						M				
0.056μF (563)	K						M				
0.068μF (683)							M				
0.10μF (104)							M				

**CAPACITANCE RANGE – X7R DIELECTRIC - SIZE 1825, 2220**

Table 2-D

SIZE	1825					2220						
	VDC (V)	1000	1500	2000	3000	4000	1000	1500	2000	2500	3000	4000
1,000pF (102)	K	K	K	K	K	K	K	K	K	K	K	K
1,200pF (122)	K	K	K	K	M	K	K	K	K	K	K	M
1,500pF (152)	K	M	K	K	M	K	K	K	K	K	K	M
1,800pF (182)	K	M	K	K	M	K	K	K	K	K	K	M
2,200pF (222)	K	M	K	K		K	K	K	K	K	K	
2,700pF (272)	K	M	K	K		K	K	K	K	K	K	
3,300pF (332)	K	K	K	K		K	K	K	K	K	K	
3,900pF (392)	K	K	K	K		K	K	K	K	K	K	
4,700pF (472)	K	K	K	K		K	K	K	K	K	K	
5,600pF (562)	K	K	K	M		K	K	K	K	K	K	
6,800pF (682)	K	K	K	M		K	K	K	M	M		
8,200pF (822)	K	K	K	M		K	M	M	M	M		
0.010μF (103)	K	K	K	M		K	M	M	M	M		
0.012μF (123)	K	M	M	U		K	M	M	U	U		
0.015μF (153)	K	M	M	U		K	M	M	U	U		
0.018μF (183)	K	M	M	U		K	U	U	U	U		
0.022μF (223)	K	M	M			K	U	U				
0.027μF (273)	K	U	U			K	U	U				
0.033μF (333)	K	U	U			K	U	U				
0.039μF (393)	K	U	U			K	U	U				
0.047μF (473)	K	U	U			K	U	U				
0.056μF (563)	K					K	U	U				
0.068μF (683)	K					M						
0.082μF (823)	M					M						
0.10μF (104)	M					M						
0.12μF (124)						M						
0.15μF (154)						U						
0.18μF (184)						U						
0.22μF (224)						U						

**CAPACITANCE RANGE – X7R DIELECTRIC - SIZE 2225**

Table 2-E

SIZE	2225				
	VDC (V)	1000	1500	2000	3000
1,000pF (102)	K	K	K	K	K
1,200pF (122)	K	K	K	K	M
1,500pF (152)	K	K	K	K	M
1,800pF (182)	K	K	K	K	M
2,200pF (222)	K	K	K	K	
2,700pF (272)	K	K	K	K	
3,300pF (332)	K	K	K	K	
3,900pF (392)	K	K	K	K	
4,700pF (472)	K	K	K	K	
5,600pF (562)	K	K	K	M	
6,800pF (682)	K	K	K	M	
8,200pF (822)	K	K	K	M	
0.010μF (103)	K	K	K	M	
0.012μF (123)	K	M	M	M	
0.015μF (153)	K	M	M	M	
0.018μF (183)	K	M	M	U	
0.022μF (223)	K	M	M		
0.027μF (273)	K	M	M		
0.033μF (333)	K	M	M		
0.039μF (393)	K	U	U		
0.047μF (473)	K	U	U		
0.056μF (563)	K	U	U		
0.068μF (683)	K				
0.082μF (823)	K				
0.10μF (104)	M				
0.12μF (124)	U				
0.15μF (154)	U				
0.18μF (184)	U				
0.22μF (224)	U				



**RELIABILITY TEST CONDITIONS AND REQUIREMENTS**

ITEM	TEST CONDITION	REQUIREMENTS												
Visual and Mechanical	-	<ul style="list-style-type: none"> <li>* No remarkable defect.</li> <li>* Dimensions to conform to individual spec. sheet.</li> </ul>												
Capacitance	<ul style="list-style-type: none"> <li>* Test temp.: Room Temperature.</li> <li>Class I: NPO (COG)</li> </ul>	* Shall not exceed the limits given in the detailed spec.												
Q/D.F (Dissipation Factor)	<ul style="list-style-type: none"> <li>• <math>Cap \leq 1000pF, 1.0 \pm 0.2V_{rms}, 1MHz \pm 10\%</math></li> <li>• <math>Cap &gt; 1000pF, 1.0 \pm 0.2V_{rms}, 1KHz \pm 10\%</math></li> <li>Class II: X7R : <math>1.0 \pm 0.2V_{rms}, 1KHz \pm 10\%</math></li> <li>*Before initial measurement (Class II only): To apply de-aging at 150° C for 1hr then set for 24 ± 2 hour at room temp.</li> </ul>	NPO (COG): <ul style="list-style-type: none"> <li>• <math>Cap \geq 30pF, Q \geq 1000;</math></li> <li>• <math>Cap &lt; 30pF, Q \geq 400+20C</math></li> </ul> X7R: $\leq 2.5\%$												
Dielectric Strength	<ul style="list-style-type: none"> <li>* To apply voltage:</li> <li>1000V~3000V <math>\geq 1.2</math> times VDC</li> <li>4000V <math>\geq 1.1</math> times VDC</li> <li>* Duration: 1 to 5 sec.</li> <li>* Charge &amp; discharge current less than 50mA</li> </ul>	* No evidence of damage or flash over during test.												
Insulation Resistance	<ul style="list-style-type: none"> <li>* Test temp.: Room Temperature. Rated voltage: <math>\geq 630V</math></li> <li>(To apply 500V for 60 sec. ) To apply rated voltage (500V max.) for 60 sec</li> </ul>	$\geq 10G\Omega$ or $RxC \geq 100\Omega-F$ whichever is smaller												
Temperature Coefficient	With no electrical load. <table border="1" data-bbox="345 1435 841 1622"> <thead> <tr> <th>T.C</th> <th>Temp. (°C)</th> </tr> </thead> <tbody> <tr> <td>NPO (COG)</td> <td>-55~125°C at 25°C</td> </tr> <tr> <td>X7R</td> <td>-55~125°C at 25°C</td> </tr> </tbody> </table> <ul style="list-style-type: none"> <li>*Before initial measurement (Class II only): To apply de-aging at 150° C for 1hr then set for 24 ± 2 hours at room temp</li> </ul>	T.C	Temp. (°C)	NPO (COG)	-55~125°C at 25°C	X7R	-55~125°C at 25°C	<table border="1" data-bbox="996 1446 1333 1725"> <thead> <tr> <th>T.C</th> <th>Capacitance Change</th> </tr> </thead> <tbody> <tr> <td>NPO (COG)</td> <td>Within <math>\pm 30ppm/^\circ C</math></td> </tr> <tr> <td>X7R</td> <td>Within <math>\pm 15\%</math></td> </tr> </tbody> </table>	T.C	Capacitance Change	NPO (COG)	Within $\pm 30ppm/^\circ C$	X7R	Within $\pm 15\%$
T.C	Temp. (°C)													
NPO (COG)	-55~125°C at 25°C													
X7R	-55~125°C at 25°C													
T.C	Capacitance Change													
NPO (COG)	Within $\pm 30ppm/^\circ C$													
X7R	Within $\pm 15\%$													

**RELIABILITY TEST CONDITIONS AND REQUIREMENTS**

ITEM	TEST CONDITION	REQUIREMENTS															
Adhesive Strength of Termination	<ul style="list-style-type: none"> <li>* Pressurizing force: 5N (<math>\leq 0603</math>) and 10N (<math>&gt;0603</math>)</li> <li>* Test time: <math>10 \pm 1</math> sec.</li> </ul>	<ul style="list-style-type: none"> <li>* No remarkable damage or removal of the terminations.</li> </ul>															
Solderability	<ul style="list-style-type: none"> <li>* Solder temperature: <math>235 \pm 5^\circ \text{C}</math></li> <li>* Dipping time: <math>2 \pm 0.5</math> sec.</li> </ul>	95% min. coverage of all metalized area.															
Resistance to Soldering Heat	<ul style="list-style-type: none"> <li>* Solder temperature: <math>260 \pm 5^\circ \text{C}</math></li> <li>* Dipping time: <math>10 \pm 1</math> sec</li> <li>* Preheating: 120 to <math>150^\circ \text{C}</math> for 1 minute before immerse the capacitor in a eutectic solder.</li> <li>* Before initial measurement (Class II only): To apply de-aging at <math>150^\circ \text{C}</math> for 1hr then set for <math>24 \pm 2</math> hours at room temp</li> <li>* Cap. / DF(Q) / I.R. Measurement to be made after de-aging at <math>150^\circ \text{C}</math> for 1hr then set for <math>24 \pm 2</math> hours at room temp.</li> </ul>	<ul style="list-style-type: none"> <li>* No remarkable damage.</li> <li>* Cap change: NP0: within <math>\pm 2.5\%</math> or <math>\pm 0.25\text{pF}</math> whichever is larger.</li> <li>X7R: within <math>\pm 7.5\%</math></li> <li>* Q/D.F., I.R. and dielectric strength: To meet initial requirements.</li> <li>* 25% max. leaching on each edge.</li> </ul>															
Temperature Cycle	<p>*Conduct the five cycles according to the temperatures and time.</p> <table border="1" data-bbox="341 1313 943 1624"> <thead> <tr> <th>Step</th> <th>Temp. (<math>^\circ \text{C}</math>)</th> <th>Time(min)</th> </tr> </thead> <tbody> <tr> <td>1</td> <td>Min. operating temp.+0/-3</td> <td><math>30 \pm 3</math></td> </tr> <tr> <td>2</td> <td>Room temp.</td> <td>2~3</td> </tr> <tr> <td>3</td> <td>Max. operating temp.+3/-0</td> <td><math>30 \pm 3</math></td> </tr> <tr> <td>4</td> <td>Room temp.</td> <td>2~3</td> </tr> </tbody> </table> <ul style="list-style-type: none"> <li>* Before initial measurement (Class II only): Perform <math>150^\circ \text{C}</math> for 1 hour and then set for <math>24 \pm 2</math> hours at room temp..</li> <li>* Cap. / DF(Q) / I.R. Measurement to be made after de-aging at <math>150^\circ \text{C}</math> for 1hr then set for <math>24 \pm 2</math> hours at room temp.</li> </ul>	Step	Temp. ( $^\circ \text{C}$ )	Time(min)	1	Min. operating temp.+0/-3	$30 \pm 3$	2	Room temp.	2~3	3	Max. operating temp.+3/-0	$30 \pm 3$	4	Room temp.	2~3	<ul style="list-style-type: none"> <li>* No remarkable damage.</li> <li>* Cap change: <ul style="list-style-type: none"> <li>• NP0 (COG): within <math>\pm 2.5\%</math> or <math>\pm 0.25\text{pF}</math> whichever is larger</li> <li>• X7R: within <math>\pm 7.5\%</math></li> </ul> </li> <li>* Q/D.F., I.R. and dielectric strength: To meet initial requirements.</li> </ul>
Step	Temp. ( $^\circ \text{C}$ )	Time(min)															
1	Min. operating temp.+0/-3	$30 \pm 3$															
2	Room temp.	2~3															
3	Max. operating temp.+3/-0	$30 \pm 3$															
4	Room temp.	2~3															

**RELIABILITY TEST CONDITIONS AND REQUIREMENTS**

ITEM	TEST CONDITION	REQUIREMENTS
<p>Vibration Resistance</p>	<p>* Vibration frequency: 10~55 Hz/min.            * Total amplitude: 1.5mm            * Test time: 6 hrs. (Two hours each in three mutually perpendicular directions.)            *Before initial measurement (Class II only): To apply de-aging at 150° C for 1hr then set for 24 ± 2 hours at room temp .            *Cap./DF(Q) Measurement to be made after de-aging at 150° C for 1hr then set for 24 ± 2 hours at room temp.</p>	<p>* No remarkable damage.            * Cap change and Q/D.F.: To meet initial spec.</p>
<p>Bending Test</p>	<p>* The middle part of substrate shall be pressurized by means of the pressurizing rod at a rate of about 1 mm per second until the deflection becomes 1 mm and then the pressure shall be maintained for 5 ± 1 sec.            *Before initial measurement (Class II only): To apply de-aging at 150° C for 1hr then set for 24 ± 2 hours at room temp .            * Measurement to be made after keeping at room temp. for 24 ± 2 hours.</p>	<p>* No remarkable damage.            * Cap change:            NP0: within ± 5.0% or ± 0.5pF whichever is larger.            X7R: within ± 12.5%            (This capacitance change means the change of capacitance under specified flexure of substrate from the capacitance measured before the test.)</p>
<p>Humidity (Damp Heat) Steady State</p>	<p>*Test temp.: 40 ± 2° C            *Humidity: 90~95% RH            *Test time: 500+24/-0 hours.            *Before initial measurement (Class II only): To apply de-aging at 150° C for 1hr then set for 24 ± 2 hours at room temp .            * Cap. / DF(Q) / I.R. Measurement to be made after de-aging at 150° C for 1hr then set for 24 ± 2 hours at room temp</p>	<p>* No remarkable damage.            * Cap change:            NP0 within ± 5% or ± 0.5pF whichever is larger            X7R within ± 12.5%            * Q/D.F Value:            NP0: Cap ≥ 30pF : Q ≥ 350            10pF ≤ Cap &lt; 30pF : Q ≥ 275 + 2.5C            Cap &lt; 10pF : Q ≥ 200 + 10C            X7R: ≤ 3.0%            * I.R.: ≥ 1GΩ or Rx C ≥ 50Ω-F whichever is smaller.</p>

**RELIABILITY TEST CONDITIONS AND REQUIREMENTS**

ITEM	TEST CONDITION	REQUIREMENTS
Humidity (Damp Heat) Load	<ul style="list-style-type: none"> <li>* Test temp.: <math>40 \pm 2^\circ \text{C}</math></li> <li>* Humidity: 90~95%RH</li> <li>* Test time: 500+24/-0 hours.</li> <li>* To apply voltage: rated voltage (Max. 500V)</li> <li>* Before initial measurement (Class II only): To apply de-aging at <math>150^\circ \text{C}</math> for 1hr then set for <math>24 \pm 2</math> hours at room temp .</li> <li>* Cap. / DF(Q) / I.R. Measurement to be made after de-aging at <math>150^\circ \text{C}</math> for 1 hour then set for <math>24 \pm 2</math> hours at room temp.</li> </ul>	<ul style="list-style-type: none"> <li>* No remarkable damage.</li> <li>* Cap change: NP0: within <math>\pm 7.5\%</math> or <math>\pm 0.75\text{pF}</math> whichever is larger.</li> <li>X7R: within <math>\pm 12.5\%</math></li> <li>* Q/D.F. value: NP0: <math>\text{Cap} \geq 30\text{pF}</math>, <math>\text{Q} \geq 200</math>; <math>\text{Cap} &lt; 30\text{pF}</math>, <math>\text{Q} \geq 100 + 10/3\text{C}</math></li> <li>X7R: <math>\leq 3.0\%</math></li> <li>• I.R.: <math>\geq 500\text{M}\Omega</math> or <math>\text{RxC} \geq 25\Omega\text{-F}</math> whichever is smaller.</li> </ul>
High Temperature Load (Endurance)	<ul style="list-style-type: none"> <li>* Test temp.:</li> <li>NP0, X7R: <math>125 \pm 3^\circ \text{C}</math></li> <li>* To apply voltage:</li> <li>• 1206/NP0 (3kV) <math>\geq 1.5\text{pF}</math>: 100% of rated voltage.</li> <li>1812N472 &amp; 1812N562(1KV): 100% of rated voltage.</li> <li>• 1000V~3000V: 120% of rated voltage.</li> <li>• 4000V: 110% of rated voltage.</li> <li>* Test time: 1000+24/-0 hrs.</li> <li>* Before initial measurement (Class II only): To apply de-aging at <math>150^\circ \text{C}</math> for 1hr then set for <math>24 \pm 2</math> hours at room temp .</li> <li>• Cap. / DF(Q) / I.R. Measurement to be made after de-aging at <math>150^\circ \text{C}</math> for 1hr then set for <math>24 \pm 2</math> hours at room temp.</li> </ul>	<ul style="list-style-type: none"> <li>* No remarkable damage.</li> <li>* Cap change:</li> <li>NP0: within <math>\pm 3\%</math> or <math>\pm 0.3\text{pF}</math> whichever is larger.</li> <li>X7R: within <math>\pm 12.5\%</math></li> <li>* Q/D.F value: NP0: <math>\text{Cap} \geq 30\text{pF}</math> : <math>\text{Q} \geq 350</math> <math>10\text{pF} \leq \text{Cap} &lt; 30\text{pF}</math> : <math>\text{Q} \geq 275 + 2.5\text{C}</math> <math>\text{Cap} &lt; 10\text{pF}</math> : <math>\text{Q} \geq 200 + 10\text{C}</math></li> <li>X7R: <math>\leq 3.0\%</math></li> <li>* I.R.: <math>\geq 1\text{G}\Omega</math> or <math>\text{RxC} \geq 50\Omega\text{-F}</math> whichever is smaller.</li> </ul>

Note:

\* "Room condition" Temperature: 15 to  $35^\circ \text{C}$ , Relative humidity: 25 to 75%, Atmospheric pressure: 86 to  $106\text{kPa}$

**RECOMMENDED PROFILE CONDITIONS**

The lead-free termination MLCCs are not only to be used on SMT against lead-free solder paste, but also suitable against lead-containing solder paste. If the optimized solder joint is requested, increasing soldering time, temperature and concentration of N<sub>2</sub> within oven are recommended.

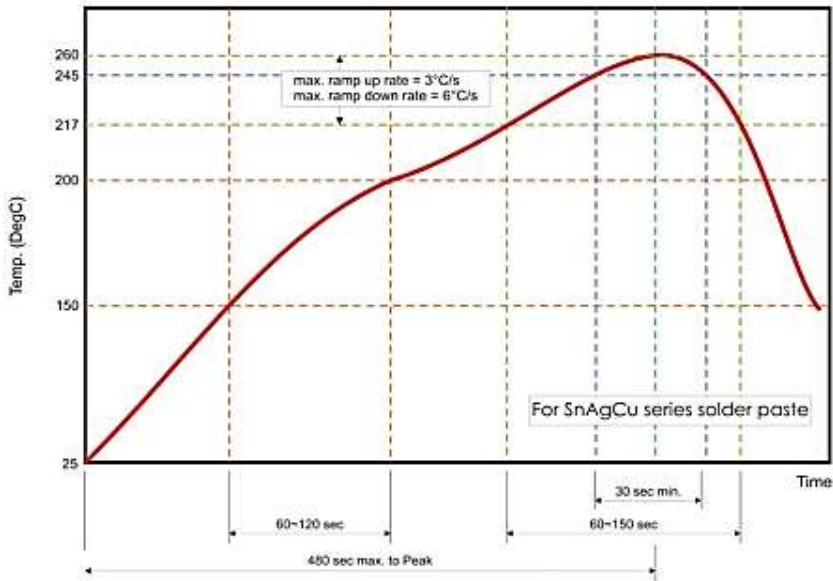

Reflow Soldering Profile For SMT Process with SnAgCu series Solder Paste



Wave Soldering Profile For SMT Process with SnAgCu series Solder Paste

## **STORAGE AND HANDLING CONDITIONS**

- To prevent the damage of solderability of terminations, the following storage conditions are recommended:  
Indoors under 5 ~ 40°C and 20% ~ 70% RH. related humidity conditions; MSL Level 1.
- The product is recommended to be used within one year after shipment. Check solderability in case of shelf life extension is needed.
- The corrosive gas reacts on the terminal electrodes of capacitors, and results in the poor solderability.  
Do not store the capacitors in the ambience of corrosive gas (e.g., hydrogen sulfide, sulfur dioxide, chlorine, ammonia gas etc.)
- In corrosive atmosphere, solderability might be degraded, and silver migration might occur to cause low reliability.
- Due to the dewing by rapid humidity change, or the photochemical change of the terminal electrode by direct sunlight, the solderability and electrical performance may deteriorate. Do not store capacitors under direct sunlight or dewing condition. To store products on the shelf and avoid exposure to moisture.

**TAPE DIMENSION** (Unit: mm)

Paper Tape



Plastic Tape

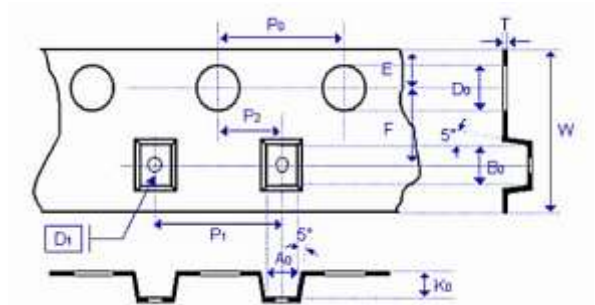

SIZE	0805		
Thickness	A,H	B,T	D,I
A0	1.50±0.20	1.50 ± 0.20	< 1.80
B0	2.30±0.20	2.30 ± 0.20	< 2.70
T	≤1.15	≤1.20	0.23±0.1
K0	-	-	< 2.00
W	8.00±0.30	8.00 ± 0.30	8.00±0.30
P0	4.00±0.10	4.00 ± 0.10	4.00±0.10
10xP0	40.00±0.20	40.00 ± 0.20	40.00 ± 0.20
P1	4.00±0.10	4.00±0.10	4.00±0.10
P2	2.00±-0.05	2.00±-0.05	2.00±0.05
D0	1.50+0.1/-0	1.50+0.1/-0	1.50+0.1/-0
D1	-	-	1.00+/-0.10
E	1.75±0.10	1.75±0.10	1.75±0.10
F	3.50±0.05	3.50±0.05	3.50±0.05

**TAPE DIMENSION** (Unit: mm)

SIZE	1206			1210			
	B,T	C,J,D	G,P	T	C,D	G,K	M
A0	1.90±0.50	<2.00	<2.30	< 3.05	< 3.05	< 3.05	< 3.20
B0	3.50±0.50	<3.70	<4.00	< 3.80	< 3.80	< 3.80	< 4.00
T	≤1.20	0.23±0.1	0.23±0.1	0.23±0.1	0.23±0.1	0.23±0.1	0.23±0.1
K0		<2.00	<2.50	<1.50	<2.00	<2.50	<3.20
W	8.00±0.30	8.00±0.30	8.00±0.30	8.00±0.30	8.00±0.30	8.00±0.30	8.00±0.30
P0	4.00±0.10	4.00±0.10	4.00±0.10	4.00±0.10	4.00±0.10	4.00±0.10	4.00±0.10
10xP0	40.0±0.20	40.0±0.20	40.0±0.20	40.0±0.20	40.0±0.20	40.0±0.20	40.0±0.20
P1	4.00±0.10	4.00±0.10	4.00±0.10	4.00±0.10	4.00±0.10	4.00±0.10	4.00±0.10
P2	2.00±0.05	2.00±0.05	2.00±0.05	2.00±0.05	2.00±0.05	2.00±0.05	2.00±0.05
D0	1.50+0.1/-0	1.50+0.1/-0	1.50+0.1/-0	1.50+0.1/-0	1.50+0.1/-0	1.50+0.1/-0	1.50+0.1/-0
D1		1.00±0.10	1.00±0.10	1.00±0.10	1.00±0.10	1.00±0.10	1.00±0.10
E	1.75±0.10	1.75±0.10	1.75±0.10	1.75±0.10	1.75±0.10	1.75±0.10	1.75±0.10
F	3.50±0.05	3.50±0.05	3.50±0.05	3.50±0.05	3.50±0.05	3.50±0.05	3.50±0.05



**TAPE DIMENSION** (Unit: mm)

SIZE	1808		1812		
	D,F	G,K	D,F	G,K	M,U
Thickness					
A0	<2.50	<2.50	< 3.90	< 3.90	< 3.90
B0	<5.30	<5.30	< 5.30	< 5.30	< 5.30
T	0.25±0.1	0.25±0.1	0.25±0.1	0.25±0.1	0.25±0.1
K0	<2.00	<2.50	< 2.00	< 2.50	< 3.50
W	12.0±0.30	12.0±0.30	12.00±0.30	12.00±0.30	12.00±0.30
P0	4.00±0.10	4.00±0.10	4.00±0.10	4.00±0.10	4.00±0.10
10xP0	40.0±0.20	40.0±0.20	40.00±0.20	40.00±0.20	40.00±0.20
P1	4.00±0.10	4.00±0.10	8.00±0.10	8.00±0.10	8.00±0.10
P2	2.00±0.10	2.00±0.10	2.00±0.10	2.00±0.10	2.00±0.10
D0	1.50+0.1/-0	1.50+0.1/-0	1.50+0.1/-0	1.50+0.1/-0	1.50+0.1/-0
D1	1.50±0.10	1.50±0.10	1.50±0.10	1.50±0.10	1.50±0.10
E	1.75±0.10	1.75±0.10	1.75±0.10	1.75±0.10	1.75±0.10
F	5.50±0.10	5.50±0.10	5.50±0.10	5.50±0.10	5.50±0.10

**TAPE DIMENSION** (Unit: mm)

SIZE	1825		2220		2225	
Thickness	K	M, U	K	M, U	K	M, U
A0	< 6.80	< 6.80	< 5.80	< 5.80	< 6.80	< 6.80
B0	< 5.30	< 5.30	< 6.50	< 6.50	< 6.50	< 6.50
T	0.30 +/-0.1	0.30 +/-0.1	0.30 +/-0.1	0.30 +/-0.1	0.30 +/-0.1	0.30 +/-0.1
K0	< 2.50	< 3.50	< 2.50	< 3.50	< 2.50	< 3.50
W	12+/-0.30	12+/-0.30	12+/-0.30	12+/-0.30	12+/-0.30	12+/-0.30
P0	4.00 +/-0.10	4.00 +/-0.10	4.00 +/-0.10	4.00 +/-0.10	4.00 +/-0.10	4.00 +/-0.10
10xP0	40.0 +/-0.20	40.0 +/-0.20	40.0 +/-0.20	40.0 +/-0.20	40.0 +/-0.20	40.0 +/-0.20
P1	8.00 +/-0.10	8.00 +/-0.10	8.00 +/-0.10	8.00 +/-0.10	8.00 +/-0.10	8.00 +/-0.10
P2	2.00 +/-0.10	2.00 +/-0.10	2.00 +/-0.10	2.00 +/-0.10	2.00 +/-0.10	2.00 +/-0.10
D0	1.50 +0.1/-0	1.50 +0.1/-0	1.50 +0.1/-0	1.50 +0.1/-0	1.50 +0.1/-0	1.50 +0.1/-0
D1	1.50 +/-0.10	1.50 +/-0.10	1.50 +/-0.10	1.50 +/-0.10	1.50 +/-0.10	1.50 +/-0.10
E	1.75 +/-0.10	1.75 +/-0.10	1.75 +/-0.10	1.75 +/-0.10	1.75 +/-0.10	1.75 +/-0.10
F	5.50 +/-0.10	5.50 +/-0.10	5.50 +/-0.10	5.50 +/-0.10	5.50 +/-0.10	5.50 +/-0.10

**REEL DIMENSION** (Unit: mm)

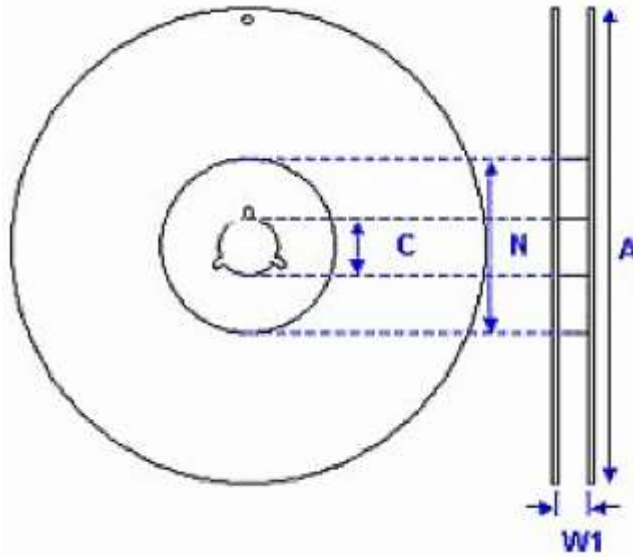

SIZE CODE	0805, 1206, 1210			1808, 1812, 1825, 2220, 2225
Reel Size	7"	10"	13"	7"
C	13.0±0.5	13.0±0.5	13.0±0.5	13.0±0.5
W 1	10.0±1.5	10.0±1.5	10.0±1.5	12.4+2.0/-0
A	178.0±2.0	250.0±2.0	330.0±2.0	178.0±2.0
N	60.0+1.0/-0	50 min	50 min	60.0+1.0/-0

**PEELING FORCE (EIA-481)**

- Peel-off force should be in the range of 10 grams to 100 grams at a peel-off speed of 300±10 mm/min.

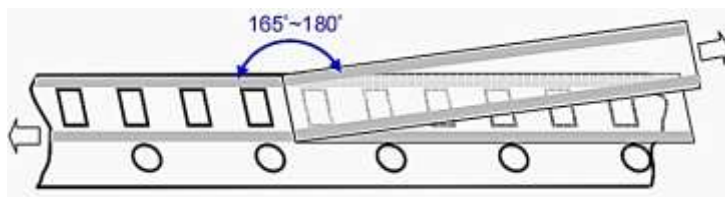

**PACKAGING STYLE AND QUANTITY PER REEL**

SIZE	THICKNESS (SYMBOL)		PAPER TAPE		PLASTIC TAPE	
			7" REEL	13" REEL	7" REEL	13" REEL
0805 (2012)	0.60±0.10	A	4,000	15,000	-	-
	0.80±0.10	B	4,000	15,000	-	-
	1.25±0.10	D	-	-	3000	10,000
	1.25±0.20	I	-	-	3000	10,000
1206 (3216)	0.80±0.10	B	4,000	15,000	-	-
	0.95±0.10	C	-	-	3,000	10,000
	1.25±0.10	D	-	-	3,000	10,000
	1.60±0.20	G	-	-	2,000	10,000
	1.60+0.30/-0.10	P	-	-	2,000	9,000
1210 (3225)	0.95±0.10	C	-	-	3,000	10,000
	1.25±0.10	D	-	-	3,000	10,000
	1.60±0.20	G	-	-	2,000	-
	2.00±0.20	K	-	-	1,000	6,000
	2.50±0.30	M	-	-	1,000	6,000
1808 (4520)	1.25±0.10	D			2,000	10,000
	1.60±0.20	G			2,000	8,000
	2.00±0.20	K			1,000	6,000
1812 (4532)	1.25±0.10	D			1,000	5,000
	1.60±0.20	G			1,000	-
	2.00±0.20	K			1,000	-
	2.50±0.30	M			500	3,000
1825 (4563) 2220 (5750) 2225 (5763)	2.00±0.20	K	-	-	1,000	-
	2.50±0.30	M	-	-	500	-
	2.80±0.30	U	-	-	500	-

## IMPORTANT NOTES AND DISCLAIMER

1. **ROHS COMPLIANCE:** The levels of RoHS restricted materials in this product are below the maximum concentration values (also referred to as the threshold limits) permitted for such substances, or are used in an exempted application, in accordance with EU RoHS Directive (EU) 2015/863 EC (RoHS3). RoHS Test Report for this product can be obtained at Download Center.
2. **REACH COMPLIANCE:** REACH substances of high concern (SVHCs) information is available for this product. Since the European Chemical Agency (ECHA) has published notice of their intent to frequently revise the SVHC listing for the foreseeable future, REACH Test Report for this product can be obtained at Download Center.
3. All Product parametric performance is indicated in the Electrical Characteristics for the listed herein test conditions, unless otherwise noted. Product performance may not be indicated by the Electrical Characteristics if operated under different conditions.
4. NextGen Component, Inc (*NextGen*) reserves the right to make changes to this document and its products and specifications at any time without notice. Customers should obtain and confirm the latest product information and specifications before final design, purchase or use.
5. *NextGen* makes no warranty, representation or guarantee regarding the suitability of its products for any particular purpose, not does *NextGen* assume any liability for application assistance or customer product design.
6. *NextGen* does not warrant or accept any liability with products which are purchased or used for any unintended or unauthorized application. No license is granted by implication or otherwise under any intellectual property rights of NextGen.
7. *NextGen* products are not authorized for use as critical components in life support devices or systems without express written approval by *NextGen*.
8. *NextGen* requires that customers first obtain an RMA (Returned Merchandise Authorization) number prior to returning any products. Returns must be made within 30 days of the date of invoice, be in the original packaging, unused and like-new condition. At the time of quoting or purchasing, a product may say that it is Non-Cancelable/ Non-Returnable (NCNR). These products are not returnable and not refundable.