



SPECIFICATION SHEET NO.	R1207- 0805B222K501BD	
ORIGINAL MFG/PART NO.	Aillen Capacitors/M0805B222K501BD	
NEXTGEN PART CODE	0805B222K501BD	Indicate This Code For RFQ/Order
DATE	Dec. 7, 2024	
REVISION	A7	Updated With Most Recent Data
DESCRIPTION AND MAIN PARAMETRICS	<p>Medium Voltage Multilayer Ceramic Chip Capacitors (MLCC), M Type, 0805 Series, Case 2012 Metric 0805 Dimension L2.00*W1.25*H0.85mm Thickness: 1.00mm Max. Dielectric X7R, Capacitance 2200pF, Tolerance ±10% Rated Voltage 500V Operating Temp. Range -55°C ~+125°C Package in Tape/Reel, 4,000pcs/Reel REACH/RoHS/RoHS III Compliant</p>	
CUSTOMER		
CUSTOMER PART NUMBER		
CROSS REF. PART NUMBER		
MEMO		

VENDOR APPROVE		
Issued/Checked/Approved		
		
Effective Date: Dec. 7, 2024		

CUSTOMER APPROVE
DATE:

DESCRIPTION

These Capacitors Feature Series Connection Of Multi-layer Capacitor Units In A MLCC To Realize Medium Voltage Performance. Reliable Performances Are Built-in Through Exact Formulation Of Dielectric Powders, Preparation Of Conductive Paste, Advanced Automatic Manufacturing, And Strict Quality Control To Assure Excellent Control In Dielectric Thickness, Electrode Integrity, And Electrode-to-termination Continuity.



Image shown is a representation only.

Exact specifications should be obtained from the product dimension.

MAIN FEATURE

- A Wide Selection Of Size Is Available
- High Capacitance and Medium Voltage 200V~630V
- High Reliability And Stability
- Temperature Characteristics: NPO (COG), X7R And Y5V
- Capacitor With Lead-free Termination
- REACH/RoHS/RoHS III Compliant



APPLICATION

- DC to DC Converter
- High Voltage Coupling/DC Blocking
- Back-lighting Inverters
- Snubbers In High Frequency Power Convertors.

ELECTRICAL CHARACTERISTICS

- See Page 4 ~Page 9 For Different Part Code And Rated Voltage.
- All Products Parameters are Subject To NextGen Components' Final Confirmation.

HOW TO ORDER

- Please Follow Up Part Code Guide And Indicate NextGen Part Code 0805B222K501BD For RFQ and Order.

RFQ
Request For Quotation

PART CODE GUIDE

CODE	NAME	KEY SPECIFICATION OPTION
0805	Case Size	0402 (1005 Metric): L1.00*W0.50mm; 0603 (1608 Metric): L1.60*W0.80mm; 0805 (2012 Metric): L2.00*W1.25mm; 1206 (3216 Metric): L3.20*W1.60mm; 1210 (3225 Metric): L3.20*W2.50mm; 1808 (4520 Metric): L4.50*W2.00mm; 1812 (4532 Metric): L4.50*W3.20mm; 1825 (4563 Metric):L4.50*W6.30mm 2220 (5750 Metric): L5.70*W5.00mm; 2225 (5763 Metric): L5.70*W6.30mm
B	Temperature Coefficient	N: NP0 (COG); B: X7R; Y: Y5V
222	Capacitance	Two significant digits followed by number of Zero, The 3rd digit signifies the multiplying factor, and letter R is decimal point. 0R5: 0.5pF; 222: 2200pF; 102: 1000pF; 471: 470pF; 332: 3300pF; 474: 0.47μF
K	Tolerance	B: ±0.1pF; C: ±0.25pF; D: ±0.5pF; F: ±1%; G: ±2%; J: ±5%; K: ±10% M: ±20%
501	Rated Voltage	201: 200 VDC; 251: 250 VDC; 451: 450 VDC; 501: 500 VDC; 631: 630 VDC
B	Thickness	B: 0.85±0.15mm, See Page 10 ~Page 11 (T's Symbol) for Different part code
D	Package	K: 0.5 Kpcs/Reel; A: 1Kpcs/Reel; B: 2Kpcs/Reel; C: 3Kpcs/Reel; D: 4Kpcs/Reel; E: 15Kpcs/Reel; I: 10Kpcs/Reel; J: 2.5Kpcs/Reel
()	Internal Control	Blank: N/A; XX: Letter A~Z, a~z or digits (0~9) for Special/Custom Parameters

ELECTRICAL CHARACTERISTICS - 200V NP0 (COG) & X7R FOR DIFFERENT PART CODE

NEXTGEN PART CODE	TEMP. COEFFICIENT	CAPACITANCE	TOLERANCE	VOLTAGE	THICKNESS (MAX.)	OPERATING TEMP. RANGE	CAPACITANCE CHARACTERISTIC
	-	-	-	V	mm	°C	-
0603B151K201XD	X7R	150 pF	±10%	200	1.00	-55 ~ 125	±15%
0603N101J201SD	NP0 (COG)	100 pF	±5%	200	0.90	-55 ~ 125	±30ppm/°C
0805B101K201BD	X7R	100 pF	±10%	200	1.00	-55 ~ 125	±15%
0805B102K201BD	X7R	1000 pF	±10%	200	1.00	-55 ~ 125	±15%
0805B103K201DC	X7R	0.01 µF	±10%	200	1.35	-55 ~ 125	±15%
0805B104K201DC	X7R	0.1 µF	±10%	200	1.35	-55 ~ 125	±15%
0805B221K201BD	X7R	220 pF	±10%	200	1.00	-55 ~ 125	±15%
0805B222K201BD	X7R	2200 pF	±10%	200	1.00	-55 ~ 125	±15%
0805B471K201BD	X7R	470 pF	±10%	200	1.00	-55 ~ 125	±15%
0805B472K201BD	X7R	4700 pF	±10%	200	1.00	-55 ~ 125	±15%
0805N101J201AD	NP0 (COG)	100 pF	±5%	200	0.70	-55 ~ 125	±30ppm/°C
0805N221J201DC	NP0 (COG)	220 pF	±5%	200	1.35	-55 ~ 125	±30ppm/°C
0805N470J201AD	NP0 (COG)	47 pF	±5%	200	0.70	-55 ~ 125	±30ppm/°C
1206B101K201DC	X7R	100 pF	±10%	200	1.35	-55 ~ 125	±15%
1206B102K201DC	X7R	1000 pF	±10%	200	1.35	-55 ~ 125	±15%
1206B152K201DC	X7R	1500 pF	±10%	200	1.35	-55 ~ 125	±15%
1206B221K201DC	X7R	220 pF	±10%	200	1.35	-55 ~ 125	±15%
1206B222K201DC	X7R	2200 pF	±10%	200	1.35	-55 ~ 125	±15%
1206B471K201DC	X7R	470 pF	±10%	200	1.35	-55 ~ 125	±15%
1206B562K201DC	X7R	5600 pF	±10%	200	1.35	-55 ~ 125	±15%

ELECTRICAL CHARACTERISTICS - 200V NP0 (COG) & X7R FOR DIFFERENT PART CODE

NEXTGEN PART CODE	TEMP. COEFFICIENT	CAPACITANCE	TOLERANCE	VOLTAGE	THICKNESS (MAX.)	OPERATING TEMP. RANGE	CAPACITANCE CHARACTERISTIC
	-	-	-	V	mm	°C	-
1206N470J201BD	NP0 (COG)	47 pF	±5%	200	1.00	-55 ~ 125	±30ppm/°C
1210B224K201MA	X7R	0.22 μF	±10%	200	2.80	-55 ~ 125	±15%

ELECTRICAL CHARACTERISTICS - 250V NP0 (COG) & X7R FOR DIFFERENT PART CODE

NEXTGEN PART CODE	TEMP. COEFFICIENT	CAPACITANCE	TOLERANCE	VOLTAGE	THICKNESS (MAX.)	OPERATING TEMP. RANGE	CAPACITANCE CHARACTERISTIC
	-	-	-	V	mm	°C	-
0603B101K251XD	X7R	100 pF	±10%	250	1.00	-55 ~ 125	±15%
0603N200J251SD	NP0 (COG)	20 pF	±5%	250	0.90	-55 ~ 125	±30ppm/°C
0805B102K251BD	X7R	1000 pF	±10%	250	1.00	-55 ~ 125	±15%
0805B103K251DC	X7R	0.01 µF	±10%	250	1.35	-55 ~ 125	±15%
0805B221K251BD	X7R	220 pF	±10%	250	1.00	-55 ~ 125	±15%
0805B221K251DC	X7R	220 pF	±10%	250	1.35	-55 ~ 125	±15%
0805B471K251BD	X7R	470 pF	±10%	250	1.00	-55 ~ 125	±15%
0805B471K251DC	X7R	470 pF	±10%	250	1.35	-55 ~ 125	±15%
0805N101J251AD	NP0 (COG)	100 pF	±5%	250	0.70	-55 ~ 125	±30ppm/°C
0805N102J251DC	NP0 (COG)	1000 pF	±5%	250	1.35	-55 ~ 125	±30ppm/°C
0805N471J251DC	NP0 (COG)	470 pF	±5%	250	1.35	-55 ~ 125	±30ppm/°C
1206B104K251GB	X7R	0.1 µF	±10%	250	1.80	-55 ~ 125	±15%
1206B222K251DC	X7R	2200 pF	±10%	250	1.35	-55 ~ 125	±15%
1206B471K251DC	X7R	470 pF	±10%	250	1.35	-55 ~ 125	±15%
1206B473K251GB	X7R	0.047 µF	±10%	250	1.80	-55 ~ 125	±15%
1206B681K251DC	X7R	680 pF	±10%	250	1.35	-55 ~ 125	±15%
1206B683K251GB	X7R	0.068 µF	±10%	250	1.80	-55 ~ 125	±15%
1206N102J251GB	NP0 (COG)	0.001 µF	±5%	250	1.80	-55 ~ 125	±30ppm/°C
1206N332J251GB	NP0 (COG)	3300 pF	±5%	250	1.80	-55 ~ 125	±30ppm/°C
1210B224K251MA	X7R	0.22 µF	±10%	250	2.80	-55 ~ 125	±15%
1812B474K251KA	X7R	0.47 µF	±10%	250	2.20	-55 ~ 125	±15%

ELECTRICAL CHARACTERISTICS - 450V NP0 (C0G) & X7R FOR DIFFERENT PART CODE

NEXTGEN PART CODE	TEMP. COEFFICIENT	CAPACITANCE	TOLERANCE	VOLTAGE	THICKNESS (MAX.)	OPERATING TEMP. RANGE	CAPACITANCE CHARACTERISTIC
	-	-	-	V	mm	°C	-
1210B2224K451MA	X7R	0.22 μ F	\pm 10%	450	2.80	-55 ~ 125	\pm 15%

ELECTRICAL CHARACTERISTICS - 500V NP0 (COG) & X7R FOR DIFFERENT PART CODE

NEXTGEN PART CODE	TEMP. COEFFICIENT	CAPACITANCE	TOLERANCE	VOLTAGE	THICKNESS (MAX.)	OPERATING TEMP. RANGE	CAPACITANCE CHARACTERISTIC
	-	-	-	V	mm	°C	-
0805B102K501BD	X7R	1000 pF	±10%	500	1.00	-55 ~ 125	±15%
0805B103K501DC	X7R	0.01 μF	±10%	500	1.35	-55 ~ 125	±15%
0805B221K501BD	X7R	220 pF	±10%	500	1.00	-55 ~ 125	±15%
0805B222K501BD	X7R	2200 pF	±10%	500	1.00	-55 ~ 125	±15%
0805B471K501BD	X7R	470 pF	±10%	500	1.00	-55 ~ 125	±15%
1206B102K501DC	X7R	1000 pF	±10%	500	1.35	-55 ~ 125	±15%
1206B103K501DC	X7R	0.01 μF	±10%	500	1.35	-55 ~ 125	±15%
1206B221K501DC	X7R	220 pF	±10%	500	1.35	-55 ~ 125	±15%
1206B332K501DC	X7R	3300 pF	±10%	500	1.35	-55 ~ 125	±15%
1206B333K501GB	X7R	0.033 μF	±10%	500	1.80	-55 ~ 125	±15%
1206B471K501DC	X7R	470 pF	±10%	500	1.35	-55 ~ 125	±15%
1206B683K501GB	X7R	0.068 μF	±10%	500	1.80	-55 ~ 125	±15%
1206N100J501BD	NP0 (COG)	10 pF	±5%	500	1.00	-55 ~ 125	±30ppm/°C
1206N102J501GB	NP0 (COG)	0.001 μF	±5%	500	1.80	-55 ~ 125	±30ppm/°C
1206N152J501GB	NP0 (COG)	1500 pF	±5%	500	1.80	-55 ~ 125	±30ppm/°C
1206N471J501CC	NP0 (COG)	470 pF	±5%	500	1.05	-55 ~ 125	±30ppm/°C
1210B104K501KA	X7R	0.1 μF	±10%	500	2.20	-55 ~ 125	±15%

ELECTRICAL CHARACTERISTICS - 630V NP0 (COG) & X7R FOR DIFFERENT PART CODE

NEXTGEN PART CODE	TEMP. COEFFICIENT	CAPACITANCE	TOLERANCE	VOLTAGE	THICKNESS (MAX.)	OPERATING TEMP. RANGE	CAPACITANCE CHARACTERISTIC
	-	-	-	V	mm	°C	-
0805N470J631AD	NP0 (COG)	47 pF	±5%	630	0.70	-55 ~ 125	±30ppm/°C
0805N471J631IC	NP0 (COG)	470 pF	±5%	630	1.45	-55 ~ 125	±30ppm/°C
1206B102K631DC	X7R	1000 pF	±10%	630	1.35	-55 ~ 125	±15%
1206B103K631DC	X7R	0.01 μF	±10%	630	1.35	-55 ~ 125	±15%
1206B221K631DC	X7R	220 pF	±10%	630	1.35	-55 ~ 125	±15%
1206B222K631DC	X7R	2200 pF	±10%	630	1.35	-55 ~ 125	±15%
1206B332K631DC	X7R	3300 pF	±10%	630	1.35	-55 ~ 125	±15%
1206B471K631DC	X7R	470 pF	±10%	630	1.35	-55 ~ 125	±15%
1206N101J631BD	NP0 (COG)	100 pF	±5%	630	1.00	-55 ~ 125	±30ppm/°C
1206N102J631GB	NP0 (COG)	1000 pF	±5%	630	1.80	-55 ~ 125	±30ppm/°C
1206N152J631GB	NP0 (COG)	1500 pF	±5%	630	1.80	-55 ~ 125	±30ppm/°C
1206N220J631BD	NP0 (COG)	22 pF	±5%	630	1.00	-55 ~ 125	±30ppm/°C
1206N221J631BD	NP0 (COG)	220 pF	±5%	630	1.00	-55 ~ 125	±30ppm/°C
1206N222J631GB	NP0 (COG)	2200 pF	±5%	630	1.80	-55 ~ 125	±30ppm/°C
1210B223K631DC	X7R	0.022 μF	±10%	630	1.35	-55 ~ 125	±15%
1210B333K631CC	X7R	0.033 μF	±10%	630	1.05	-55 ~ 125	±15%
1210B393K631GB	X7R	0.039 μF	±10%	630	1.80	-55 ~ 125	±15%
1210B473K631GB	X7R	0.047 μF	±10%	630	1.80	-55 ~ 125	±15%
1812B104K631KA	X7R	0.1 μF	±10%	630	2.20	-55 ~ 125	±15%

DIMENSION (Unit: mm)

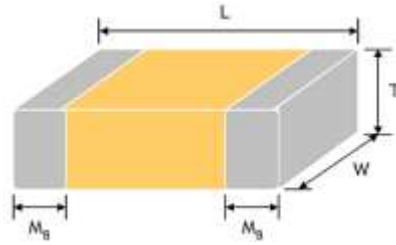

SIZE CODE	METRIC CODE	L	W	T (SYMBOL)		Mb
0402	1005	1.00±0.05	0.50±0.10	0.50 ±0.05	N	0.15 Min.
0603	1608	1.60±0.15	0.80±0.15	0.80±0.10	S	0.20 Min.
				0.80±0.20	X	
0805	2012	2.00±0.20	1.25±0.20	0.60±0.10	A	0.30 Min.
				0.85±0.15	B	
				1.25±0.10	D	
				1.25±0.20	I	
1206	3216	3.20±0.20	1.60±0.20	0.85±0.15	B	0.3 Min.
				0.95±0.10	C	
				1.25±0.10	D	
				1.60±0.20	G	
1210	3225	3.20±0.40	2.50±0.30	0.95±0.10	C	0.3 Min.
				1.25±0.10	D	
				1.60±0.20	G	
				2.00±0.20	K	
				2.50±0.30	M	
1808	4520	4.50±0.40	2.00±0.20	1.25±0.10	D	0.26 Min.
				1.60±0.20	G	
				2.00±0.20	K	

DIMENSION (Unit: mm)

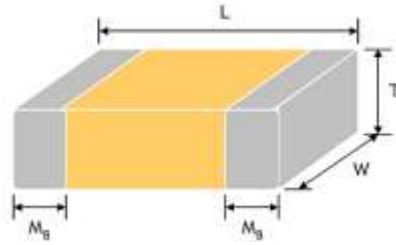

SIZE CODE	METRIC CODE	L	W	T (SYMBOL)		REMARK	MB
1812	4532	4.50±0.40	3.20±0.30	1.25±0.10	D		0.26 Min.
				1.60±0.20	G		
				2.00±0.20	K		
				2.50±0.30	M		
1825	4563	4.50±0.40	6.30±0.40	2.00±0.20	K		0.30 Min.
				2.50±0.30	M		
				2.80±0.30	U		
2220	5750	5.70±0.40	5.00±0.40	2.00±0.20	K		0.30 Min.
				2.50±0.30	M		
				2.80±0.30	U		
2225	5763	5.70±0.40	6.30±0.40	2.00±0.20	K		0.30 Min.
				2.50±0.30	M		
				2.80±0.30	U		

GENERAL ELECTRICAL CHARACTERISTICS

DIELECTRIC	NPO (COG)	X7R	Y5V
Size	0402, 0603, 0805, 1206, 1210, 1808, 1812, 1825, 2220, 2225	0603, 0805, 1206, 1210, 1808, 1812, 1825, 2220, 2225	0805, 1206, 1210, 1812
Capacitance Range*	0.5pF to 0.1μF	100pF to 22μF	10nF to 1.0μF
Capacitance Tolerance	Cap. ≤5pF: B (±0.1pF), C (±0.25pF) 5pF < Cap < 10pF: C (±0.25pF), D (±0.5pF) Cap ≥10pF: F (±1%), G (±2%), J (±5%), K (±10%)	J (±5%) #1 K (±10%), M (±20%)	Z (-20/+80%)
Rated Voltage	200V, 250V, 500V, 630V	200V, 250V, 500V, 630V	200V, 250V
Q/DF (Tan δ) *	Cap < 30pF: Cap ≥ 400 + 20C Cap ≥ 30pF: Q ≥ 1000	DF ≤ 2.5% (Apply 1.0 ± 0.2Vrms, 1.0kHz ± 10%)	≤ 5%
Insulation resistance at Ur**	≥ 100GΩ or R • C ≥ 1000 whichever is smaller	≥ 10GΩ or R • C ≥ 100Ω • F whichever is smaller	
Operating Temperature	-55 ~ +125°C		-25 ~ +85°C
Capacitance Characteristic	±30ppm/°C	±15%	+30/-80%
Termination	Cu (or Ag)/Ni/Sn (lead-free termination)		
Note:			

- * Measured at the condition of 30~70% related humidity.
- NPO (COG): Apply 1.0 ± 0.2Vrms, 1.0MHz ± 10% for Cap ≤ 1000pF and 1.0 ± 0.2Vrms, 1.0kHz ± 10% for Cap > 1000pF, 25° C at ambient temperature.
- X7R: Apply 1.0 ± 0.2Vrms, 1.0kHz ± 10%, at 25° C ambient temperature
- Y5V: Apply 1.0 ± 0.2Vrms, 1.0kHz ± 10%, at 20° C ambient temperature.
- **Measured at 500VDC for 60 sec, for UR > 500VDC

CAPACITANCE RANGE - NPO (COG) DIELECTRIC - SIZE 0402, 0603, 0805

Table 1-A

SIZE	0402		0603		0805			
VDC (V)	200	250	200	250	200	250	500	630
0.5pF(0R5)	N	N	S	S	A	A	A	A
1.0pF(1R0)	N	N	S	S	A	A	A	A
1.2pF (1R2)	N	N	S	S	A	A	A	A
1.5pF (1R5)	N	N	S	S	A	A	A	A
1.8pF (1R8)	N	N	S	S	A	A	A	A
2.2pF (2R2)	N	N	S	S	A	A	A	A
2.7pF (2R7)	N	N	S	S	A	A	A	A
3.3pF (3R3)	N	N	S	S	A	A	A	A
3.9pF (3R9)	N	N	S	S	A	A	A	A
4.7pF (4R7)	N	N	S	S	A	A	A	A
5.6pF (5R6)	N	N	S	S	A	A	A	A
6.8pF (6R8)	N	N	S	S	A	A	A	A
8.2pF (8R2)	N	N	S	S	A	A	A	A
10pF (100)	N	N	S	S	A	A	A	A
12pF (120)	N	N	S	S	A	A	A	A
15pF (150)	N	N	S	S	A	A	A	A
18pF (180)	N	N	S	S	A	A	A	A
20pF (200)	N	N	S	S	A	A	A	A
22pF (220)	N	N	S	S	A	A	A	A
27pF (270)	N	N	S	S	A	A	A	A
33pF (330)	N	N	S	S	A	A	A	A
39pF (390)	N	N	S	S	A	A	A	A
47pF (470)	N	N	S	S	A	A	A	A
56pF (560)	N	N	S	S	A	A	A	A
68pF (680)	N		S	S	A	A	A	A
82pF (820)	N		S	S	A	A	A	A
100pF (101)	N		S	S	A	A	A	A
120pF (121)			S	S	A	B	D	D
150pF (151)			S	S	B	D	D	D
180pF (181)			S	S	B	D	D	D

CAPACITANCE RANGE - NPO (COG) DIELECTRIC - SIZE 0402, 0603, 0805

Table 1-B

SIZE	0402		0603		0805			
	VDC (V)	200	250	200	250	200	250	500
220pF (221)			S	S	D	D	D	D
270pF (271)			X	X	D	D	D	D
330pF (331)			X	X	D	D	D	D
390pF (391)			X	X	D	D	D	D
470pF (471)			X	X	D	D	I	I
560pF (561)			X	X	D	D	I	I
680pF (681)					D	D	I	I
820pF (821)					D	D	I	I
1,000pF(102)					D	D	I	I
1,200pF (122)					D	D		
1,500pF (152)					D	D		
1,800pF (182)					D	D		
2,200pF (222)					D	D		

CAPACITANCE RANGE - NPO (COG) DIELECTRIC - SIZE 1206, 1210

Table 1-C

SIZE	1206				1210			
	VDC (V)	200	250	500	630	200	250	500
1.5pF (1R5)	B	B	B	B				
1.8pF (1R8)	B	B	B	B				
2.2pF (2R2)	B	B	B	B				
2.7pF (2R7)	B	B	B	B				
3.3pF (3R3)	B	B	B	B				
3.9pF (3R9)	B	B	B	B				
4.7pF (4R7)	B	B	B	B				
5.6pF (5R6)	B	B	B	B				
6.8pF (6R8)	B	B	B	B				
8.2pF (8R2)	B	B	B	B				
10pF (100)	B	B	B	B	C	C	C	C
12pF (120)	B	B	B	B	C	C	C	C
15pF (150)	B	B	B	B	C	C	C	C

CAPACITANCE RANGE - NP0 (COG) DIELECTRIC - SIZE 1206, 1210

Table 1-D

SIZE	1206				1210			
VDC (V)	200	250	500	630	200	250	500	630
18pF (180)	B	B	B	B	C	C	C	C
20pF (200)	B	B	B	B	C	C	C	C
22pF (220)	B	B	B	B	C	C	C	C
27pF (270)	B	B	B	B	C	C	C	C
33pF (330)	B	B	B	B	C	C	C	C
39pF (390)	B	B	B	B	C	C	C	C
47pF (470)	B	B	B	B	C	C	C	C
56pF (560)	B	B	B	B	C	C	C	C
68pF (680)	B	B	B	B	C	C	C	C
82pF (820)	B	B	B	B	C	C	C	C
100pF (101)	B	B	B	B	C	C	C	C
120pF (121)	B	B	B	B	C	C	C	C
150pF (151)	B	B	B	B	C	C	C	C
180pF (181)	B	B	B	B	C	C	C	C
220pF (221)	B	B	B	B	C	C	C	C
270pF (271)	B	C	C	C	C	C	C	C
330pF (331)	B	C	C	C	C	C	C	C
390pF (391)	B	C	C	C	C	C	C	C
470pF (471)	C	C	C	C	C	C	C	C
560pF (561)	C	C	C	C	C	C	C	C
680pF (681)	C	D	D	D	C	C	C	C
820pF (821)	C	D	D	D	C	C	C	C
1,000pF(102)	C	G	G	G	D	D	D	D
1,200pF (122)	C	G	G	G	D	D	D	D
1,500pF (152)	D	G	G	G	D	D	D	D
1,800pF (182)	D	G	G	G	D	D	D	D
2,200pF (222)	D	G	G	G	D	D	D	D
2,700pF (272)	D	G			D	D	D	D
3,300pF (332)	D	G			D	D	D	D

CAPACITANCE RANGE - NP0 (COG) DIELECTRIC - SIZE 1206, 1210

Table 1-E

SIZE	1206				1210			
VDC (V)	200	250	500	630	200	250	500	630
3,900pF (392)	D	G			D	D	D	D
4,700pF (472)	D	G			G	G		
5,600pF (562)					G	G		
6,800pF (682)					G	G		
8,200pF (822)					G	G		
0.010μF (103)					G	G		
0.022μF (223)					M	M		
0.033μF (333)					M	M		

CAPACITANCE RANGE - NP0 (COG) DIELECTRIC - SIZE 1808, 1812

Table 1-F

SIZE	1808		1812			
VDC (V)	500	630	200	250	500	630
1.8pF (1R8)	D	D				
2.2pF (2R2)	D	D				
2.7pF (2R7)	D	D				
3.3pF (3R3)	D	D				
3.9pF (3R9)	D	D				
4.7pF (4R7)	D	D				
5.6pF (5R6)	D	D				
6.8pF (6R8)	D	D				
8.2pF (8R2)	D	D				
10pF (100)	D	D	D	D	D	D
12pF (120)	D	D	D	D	D	D
15pF (150)	D	D	D	D	D	D
18pF (180)	D	D	D	D	D	D
20pF (200)	D	D	D	D	D	D
22pF (220)	D	D	D	D	D	D
27pF (270)	D	D	D	D	D	D
33pF (330)	D	D	D	D	D	D

CAPACITANCE RANGE - NPO (COG) DIELECTRIC - SIZE 1808, 1812

Table 1-G

SIZE	1808		1812			
	500	630	200	250	500	630
VDC (V)						
39pF (390)	D	D	D	D	D	D
47pF (470)	D	D	D	D	D	D
56pF (560)	D	D	D	D	D	D
68pF (680)	D	D	D	D	D	D
82pF (820)	D	D	D	D	D	D
100pF (101)	D	D	D	D	D	D
120pF (121)	D	D	D	D	D	D
150pF (151)	D	D	D	D	D	D
180pF (181)	D	D	D	D	D	D
220pF (221)	D	D	D	D	D	D
270pF (271)	K	K	D	D	D	D
330pF (331)	K	K	D	D	D	D
390pF (391)	K	K	D	D	D	D
470pF (471)	K	K	D	D	D	D
560pF (561)	K	K	D	D	D	D
680pF (681)	K	K	D	D	D	D
820pF (821)	K	K	D	D	D	D
1,000pF(102)	K	K	D	D	D	D
1,200pF (122)	K	K	D	D	D	D
1,500pF (152)	K	K	D	D	D	D
1,800pF (182)	K	K	D	D	D	D
2,200pF (222)	K	K	D	D	D	D
2,700pF (272)			D	D	D	D
3,300pF (332)			D	D	D	D
3,900pF (392)			D	D	D	D
4,700pF (472)			D	D	D	D
5,600pF (562)			D	D	D	D
6,800pF (682)			D	D	D	D
8,200pF (822)					D	D
0.010μF (103)					D	D
0.022μF (223)					K	K
0.033μF (333)					M	M

CAPACITANCE RANGE - NP0 (COG) DIELECTRIC - SIZE 1825, 2220, 2225

Table 1-H

SIZE	1825				2220				2225			
VDC (V)	200	250	500	630	200	250	500	630	200	250	500	630
10pF (100)	K	K	K	K	K	K	K	K	K	K	K	K
12pF (120)	K	K	K	K	K	K	K	K	K	K	K	K
15pF (150)	K	K	K	K	K	K	K	K	K	K	K	K
18pF (180)	K	K	K	K	K	K	K	K	K	K	K	K
22pF (220)	K	K	K	K	K	K	K	K	K	K	K	K
27pF (270)	K	K	K	K	K	K	K	K	K	K	K	K
33pF (330)	K	K	K	K	K	K	K	K	K	K	K	K
39pF (390)	K	K	K	K	K	K	K	K	K	K	K	K
47pF (470)	K	K	K	K	K	K	K	K	K	K	K	K
56pF (560)	K	K	K	K	K	K	K	K	K	K	K	K
68pF (680)	K	K	K	K	K	K	K	K	K	K	K	K
82pF (820)	K	K	K	K	K	K	K	K	K	K	K	K
100pF (101)	K	K	K	K	K	K	K	K	K	K	K	K
120pF (121)	K	K	K	K	K	K	K	K	K	K	K	K
150pF (151)	K	K	K	K	K	K	K	K	K	K	K	K
180pF (181)	K	K	K	K	K	K	K	K	K	K	K	K
220pF (221)	K	K	K	K	K	K	K	K	K	K	K	K
270pF (271)	K	K	K	K	K	K	K	K	K	K	K	K
330pF (331)	K	K	K	K	K	K	K	K	K	K	K	K
390pF (391)	K	K	K	K	K	K	K	K	K	K	K	K
470pF (471)	K	K	K	K	K	K	K	K	K	K	K	K
560pF (561)	K	K	K	K	K	K	K	K	K	K	K	K
680pF (681)	K	K	K	K	K	K	K	K	K	K	K	K
820pF (821)	K	K	K	K	K	K	K	K	K	K	K	K
1,000pF (102)	K	K	K	K	K	K	K	K	K	K	K	K
1,200pF (122)	K	K	K	K	K	K	K	K	K	K	K	K
1,500pF (152)	K	K	K	K	K	K	K	K	K	K	K	K
1,800pF (182)	K	K	K	K	K	K	K	K	K	K	K	K
2,200pF (222)	K	K	K	K	K	K	K	K	K	K	K	K
2,700pF (272)	K	K	K	K	K	K	K	K	K	K	K	K

CAPACITANCE RANGE - NPO (COG) DIELECTRIC - SIZE 1825, 2220, 2225

Table 1-I

SIZE	1825				2220				2225			
VDC (V)	200	250	500	630	200	250	500	630	200	250	500	630
3,300pF (332)	K	K	K	K	K	K	K	K	K	K	K	K
3,900pF (392)	K	K	K	K	K	K	K	K	K	K	K	K
4,700pF (472)	K	K	K	K	K	K	K	K	K	K	K	K
5,600pF (562)	K	K	K	K	K	K	K	K	K	K	K	K
6,800pF (682)	K	K	K	K	K	K	K	K	K	K	K	K
8,200pF (822)	K	K	K	K	K	K	K	K	K	K	K	K
0.010uF (103)	K	K	K	K	K	K	K	K	K	K	K	K
0.012uF (123)	K	K	K	K	K	K	K	K	K	K	K	K
0.015uF (153)	K	K	K	K	K	K	K	K	K	K	K	K
0.018uF (183)	K	K	K	K	K	K	K	K	K	K	K	K
0.022uF (223)	K	K	K	K	K	K	K	K	K	K	K	K
0.027uF (273)	K	K	K	K	K	K	K		K	K	K	K
0.033uF (333)	K	K	K	K	K	K	K		K	K	K	K
0.039uF (393)	K	K	M	M	K	K	M		K	K	K	K
0.047uF (473)	K				M	M	M		K	K	K	K
0.056uF (563)	M				M	M			M	M	M	M
0.068uF (683)	M				M	M			M	M	M	M
0.082uF (823)									M	M	M	
0.1uF (104)									M	M		

CAPACITANCE RANGE – X7R DIELECTRIC - SIZE 0603, 0805, 1206

Table 2-A

SIZE	0603		0805				1206			
	VDC (V)	200	250	200	250	500	630	200	250	500
100pF (101)	X	X	B	B	B	B	D	D	D	D
120pF (121)	X	X	B	B	B	B	D	D	D	D
150pF (151)	X	X	B	B	B	B	D	D	D	D
180pF (181)	X	X	B	B	B	B	D	D	D	D
220pF (221)	X	X	B	B	B	B	D	D	D	D
270pF (271)	X	X	B	B	B	B	D	D	D	D
330pF (331)	X	X	B	B	B	B	D	D	D	D
390pF (391)	X	X	B	B	B	B	D	D	D	D
470pF (471)	X	X	B	B	B	B	D	D	D	D
560pF (561)	X	X	B	B	B	B	D	D	D	D
680pF (681)	X	X	B	B	B	B	D	D	D	D
820pF (821)	X	X	B	B	B	B	D	D	D	D
1,000pF (102)	X	X	B	B	B	B	D	D	D	D
1,200pF (122)	X	X	B	B	B	B	D	D	D	D
1,500pF (152)	X	X	B	B	B	B	D	D	D	D
1,800pF (182)	X	X	B	B	B	B	D	D	D	D
2,200pF (222)	X	X	B	B	B	B	D	D	D	D
2,700pF (272)	X	X	B	B	B	B	D	D	D	D
3,300pF (332)	X	X	B	B	B	B	D	D	D	D
3,900pF (392)	X	X	B	B	B	B	D	D	D	D
4,700pF (472)	X	X	B	B	D	D	D	D	D	D
5,600pF (562)	X	X	D	D	D	D	D	D	D	D
6,800pF (682)	X	X	D	D	D	D	D	D	D	D
8,200pF (822)	X	X	D	D	D	D	D	D	D	D
0.010μF (103)	X	X	D	D	D	D	D	B/ D	D	D
0.012μF (123)			D	D	D	D	D	D	D	D
0.015μF (153)			D	D	D	D	D	D	D	D
0.018μF (183)			D	D	D	D	D	D	D	D
0.022μF (223)			D	D	D	D	D	D	G	G
0.027μF (273)			D	D			D	D	G	G

CAPACITANCE RANGE – X7R DIELECTRIC - SIZE 0603, 0805, 1206

Table 2-B

SIZE	0805				1206						
	VDC (V)	200	250	500	630	200	250	400	450	500	630
0.033μF (333)	D	D				G	G			G	G
0.039μF (393)	D	D				G	G			G	G
0.047μF (473)	D	D				G	G			G	G
0.056μF (563)	D	D				G	G			G	G
0.068μF (683)	D	D				G	G	G	G		
0.082μF (823)	D					G	G	G	G		
0.10μF (104)	D					G	G	G	G		
0.12μF (124)						G	G				
0.15μF (154)						G	G				
0.18μF (184)						G	G				
0.22μF (224)						G	G				

CAPACITANCE RANGE – X7R DIELECTRIC - SIZE 1210, 1808, 1812

Table 2-C

SIZE	1210				1808		1812				
	VDC (V)	200	250	500	630	500	630	200	250	500	630
100pF (101)	D	D	D	D							
120pF (121)	D	D	D	D							
150pF (151)	D	D	D	D	D	D					
180pF (181)	D	D	D	D	D	D					
220pF (221)	D	D	D	D	D	D					
270pF (271)	D	D	D	D	D	D					
330pF (331)	D	D	D	D	D	D					
390pF (391)	D	D	D	D	D	D					
470pF (471)	D	D	D	D	D	D					
560pF (561)	D	D	D	D	D	D					
680pF (681)	C	C	D	D	D	D					
820pF (821)	C	C	D	D	D	D					
1,000pF (102)	C	C	D	D	D	D	D	D	D	D	D
1,200pF (122)	C	C	D	D	D	D	D	D	D	D	D
1,500pF (152)	C	C	D	D	D	D	D	D	D	D	D

CAPACITANCE RANGE – X7R DIELECTRIC - SIZE 1210, 1808, 1812

Table 2-D

SIZE	1210				1808		1812				
	VDC (V)	200	250	500	630	500	630	200	250	500	630
1,800pF (182)	C	C	D	D	D	D	D	D	D	D	D
2,200pF (222)	C	C	D	D	D	D	D	D	D	D	D
2,700pF (272)	C	C	D	D	D	D	D	D	D	D	D
3,300pF (332)	C	C	D	D	D	D	D	D	D	D	D
3,900pF (392)	C	C	D	D	D	D	D	D	D	D	D
4,700pF (472)	C	C	D	D	D	D	D	D	D	D	D
5,600pF (562)	C	C	D	D	K	K	D	D	D	D	D
6,800pF (682)	C	C	D	D	K	K	D	D	D	D	D
8,200pF (822)	C	C	D	D	K	K	D	D	D	D	D
0.010μF (103)	C	C	D	D	K	K	D	D	D	D	D
0.012μF (123)	C	C	D	D	K	K	D	D	D	D	D
0.015μF (153)	C	C	D	D	K	K	D	D	D	D	D
0.018μF (183)	C	C	D	D	K	K	D	D	D	D	D
0.022μF (223)	C	C	D	D	K	K	D	D	D	D	D
0.027μF (273)	C	C	G	G	K	K	D	D	D	D	D
0.033μF (333)	C	C	G	G	K	K	D	D	D	D	D
0.039μF (393)	C	C	G	G	K	K	D	D	D	D	D
0.047μF (473)	D	D	G	G	K	K	D	D	D	D	D
0.056μF (563)	D	D	G	G	K	K	D	D	K	K	K
0.068μF (683)	G	G	K	K	K	K	D	D	K	K	K
0.082μF (823)	G	G	K	K	K	K	D	D	K	K	K
0.10μF (104)	G	G	K	K			D	D	K	K	K

CAPACITANCE RANGE – X7R DIELECTRIC - SIZE 1210, 1808, 1812

Table 2-E

SIZE	1210						1812				
	VDC (V)	200	250	400	450	500	630	200	250	500	630
0.12µF (124)	G	G	M	M	M	M		D	D	M	M
0.15µF (154)	M	M	M	M	M	M		K	K	M	M
0.18µF (184)	M	M	M	M				K	K	M	M
0.22µF (224)	M	M	M	M				K	K	M	M
0.27µF (274)	M	M	M	M				K	K	M	
0.33µF (334)	M	M	M	M				K	K	M	
0.39µF (394)	M	M						K	K	M	
0.47µF (474)	M	M						K	K	M	
0.56µF (564)	M	M						M	M		
0.68µF (684)	M	M						M	M		
0.84µF (844)								M	M		
1.0µF (105)								M	M		

CAPACITANCE RANGE – X7R DIELECTRIC - SIZE 1825, 2220, 2225

Table 2-F

Size	1825				2220				2225				
	VDC (V)	200	250	500	630	200	250	500	630	200	250	500	630
1,000pF (102)	K	K	K	K	K	K	K	K	K	K	K	K	K
1,200pF (122)	K	K	K	K	K	K	K	K	K	K	K	K	K
1,500pF (152)	K	K	K	K	K	K	K	K	K	K	K	K	K
1,800pF (182)	K	K	K	K	K	K	K	K	K	K	K	K	K
2,200pF (222)	K	K	K	K	K	K	K	K	K	K	K	K	K
2,700pF (272)	K	K	K	K	K	K	K	K	K	K	K	K	K
3,300pF (332)	K	K	K	K	K	K	K	K	K	K	K	K	K
3,900pF (392)	K	K	K	K	K	K	K	K	K	K	K	K	K
4,700pF (472)	K	K	K	K	K	K	K	K	K	K	K	K	K
5,600pF (562)	K	K	K	K	K	K	K	K	K	K	K	K	K

CAPACITANCE RANGE – X7R DIELECTRIC - SIZE 1825, 2220, 2225

Table 2-G

SIZE	1825				2220				2225				
	VDC (V)	200	250	500	630	200	250	500	630	200	250	500	630
6,800pF (682)	K	K	K	K	K	K	K	K	K	K	K	K	K
8,200pF (822)	K	K	K	K	K	K	K	K	K	K	K	K	K
0.010µF (103)	K	K	K	K	K	K	K	K	K	K	K	K	K
0.012µF (123)	K	K	K	K	K	K	K	K	K	K	K	K	K
0.015µF (153)	K	K	K	K	K	K	K	K	K	K	K	K	K
0.018µF (183)	K	K	K	K	K	K	K	K	K	K	K	K	K
0.022µF (223)	K	K	K	K	K	K	K	K	K	K	K	K	K
0.027µF (273)	K	K	K	K	K	K	K	K	K	K	K	K	K
0.033µF (333)	K	K	K	K	K	K	K	K	K	K	K	K	K
0.039µF (393)	K	K	K	K	K	K	K	K	K	K	K	K	K
0.047µF (473)	K	K	K	K	K	K	K	K	K	K	K	K	K
0.056µF (563)	K	K	K	K	K	K	K	K	K	K	K	K	K
0.068µF (683)	K	K	K	K	K	K	K	K	K	K	K	K	K
0.082µF (823)	K	K	K	K	K	K	K	K	K	K	K	K	K
0.10µF (104)	K	K	K	K	K	K	K	K	K	K	K	K	K
0.12µF (124)	K	K	K	K	K	K	K	K	K	K	K	K	K
0.15µF (154)	K	K	K	K	K	K	K	K	K	K	K	K	K
0.18µF (184)	K	K	K	K	K	K	K	K	K	K	K	K	K
0.22µF (224)	K	K	K	K	K	K	K	K	K	K	K	K	K
0.27µF (274)	K	K	K	K	K	K	K	K	K	K	K	K	K
0.33µF (334)	K	K	K	K	K	K	K	K	K	K	K	K	K
0.39µF (394)	K	K	K	K	K	K	K	K	K	K	K	K	K
0.47µF (474)	K	K	K	K	K	K	K	K	K	K	K	K	K
0.56µF (564)	K	K	M	M	K	K	M	M	K	K	K	K	K
0.68µF (684)	K	K			K	K	M	M	K	K			
0.82µF (824)	K	K			K	K	U	U	K	K			
1.0µF (105)	K	K			K	K	U	U	K	K			
1.5µF (155)					M	M			M	M			
2.2µF (225)					M	M			M	M			

RELIABILITY TEST CONDITIONS AND REQUIREMENTS

ITEM	TEST CONDITION	REQUIREMENTS																
Visual and Mechanical	-	<ul style="list-style-type: none"> * No remarkable defect. * Dimensions to conform to individual spec. sheet. 																
Capacitance	* Test temp.: Room Temperature. Class I: NPO (COG)	* Shall not exceed the limits given in the detailed spec.																
Q/D.F (Dissipation Factor)	Cap. ≤1000pF, 1.0 ± 0.2Vrms, 1MHz ± 10% Cap. > 1000pF, 1.0 ± 0.2Vrms, 1KHz ± 10% Class II: (X7R, Y5V) : 1.0 ± 0.2Vrms, 1KHz ± 10%	NPO (COG): <ul style="list-style-type: none"> • Cap ≥ 30pF, Q ≥ 1000; • Cap < 30pF, Q ≥ 400 + 20C X7R: ≤ 2.5% Y5V: ≤ 5.0%																
Temperature Coefficient	With no electrical load. <table border="1" data-bbox="325 959 819 1207"> <thead> <tr> <th>T.C</th> <th>Temp. (°C)</th> </tr> </thead> <tbody> <tr> <td>NPO (COG)</td> <td>-55~125°C at 25°C</td> </tr> <tr> <td>X7R</td> <td>-55~125°C at 25°C</td> </tr> <tr> <td>Y5V</td> <td>-25~85°C at 20°C</td> </tr> </tbody> </table>	T.C	Temp. (°C)	NPO (COG)	-55~125°C at 25°C	X7R	-55~125°C at 25°C	Y5V	-25~85°C at 20°C	<table border="1" data-bbox="998 913 1333 1305"> <thead> <tr> <th>T.C</th> <th>Capacitance Change</th> </tr> </thead> <tbody> <tr> <td>NPO (COG)</td> <td>Within ±30ppm/°C</td> </tr> <tr> <td>X7R</td> <td>Within ±15%</td> </tr> <tr> <td>Y5V</td> <td>Within +30%/-80%</td> </tr> </tbody> </table>	T.C	Capacitance Change	NPO (COG)	Within ±30ppm/°C	X7R	Within ±15%	Y5V	Within +30%/-80%
T.C	Temp. (°C)																	
NPO (COG)	-55~125°C at 25°C																	
X7R	-55~125°C at 25°C																	
Y5V	-25~85°C at 20°C																	
T.C	Capacitance Change																	
NPO (COG)	Within ±30ppm/°C																	
X7R	Within ±15%																	
Y5V	Within +30%/-80%																	
Insulation Resistance	UR=100V: To apply voltage at UR for max. 120 sec. UR>100V: To apply voltage at UR (500V max.) for 60 sec.	≥10GΩ or RxC ≥ 100Ω-F whichever is smaller.																
Dielectric Strength	* To apply voltage: <ul style="list-style-type: none"> • 200V/250V = 2 times of UR • 500V/630V = 1.5 times of UR * Duration: 1 to 5 sec	* No evidence of damage or flash over during test.																
Solderability	* Solder temperature: 235 ± 5° C * Dipping time: 2 ± 0.5 sec.	95% min. coverage of all metalized area.																

RELIABILITY TEST CONDITIONS AND REQUIREMENTS

ITEM	TEST CONDITION	REQUIREMENTS															
<p>Resistance to Soldering Heat</p>	<p>* Solder temperature: 260±5°C</p> <p>* Dipping time: 10±1 sec</p> <p>* Preheating: 120 to 150°C for 1 minute before immerse the capacitor in a eutectic solder.</p> <p>* Before initial measurement (Class II only): Perform 150+0/-10°C for 1 hr and then set for 48±4 hrs at room temp.</p> <p>* Measurement to be made after keeping at room temp. for 24±2hrs (Class I) or 48±4 hrs (Class II).</p>	<p>* No remarkable damage.</p> <p>* Cap change: NP0 (COG): within ±2.5% or ±0.25pF whichever is larger. X7R: within ±7.5% Y5V: within ±20%</p> <p>* Q/D.F.: NP0 (COG)/ X7R/ Y5V : ≤ 1.0 × Initial requirement</p> <p>* 25% max. leaching on each edge.</p>															
<p>Temperature Cycle</p>	<p>*Conduct the five cycles according to the temperatures and time.</p> <table border="1" data-bbox="337 990 939 1301"> <thead> <tr> <th>Step</th> <th>Temp. (°C)</th> <th>Time(min)</th> </tr> </thead> <tbody> <tr> <td>1</td> <td>Min. operating temp.+0/-3</td> <td>30±3</td> </tr> <tr> <td>2</td> <td>Room temp.</td> <td>2~3</td> </tr> <tr> <td>3</td> <td>Max. operating temp.+3/-0</td> <td>30±3</td> </tr> <tr> <td>4</td> <td>Room temp.</td> <td>2~3</td> </tr> </tbody> </table> <p>* Before initial measurement (Class II only): Perform 150+0/-10° C for 1 hr and then set for 48 ± 4 hrs at room temp.</p> <p>* Measurement to be made after keeping at room temp. for 24 ± 2 hrs (Class I) or 48 ± 4 hrs (Class II).</p>	Step	Temp. (°C)	Time(min)	1	Min. operating temp.+0/-3	30±3	2	Room temp.	2~3	3	Max. operating temp.+3/-0	30±3	4	Room temp.	2~3	<p>* No remarkable damage.</p> <p>* Cap change:</p> <ul style="list-style-type: none"> NP0 (COG): within ± 2.5% or 0.25pF whichever is larger X7R: within ± 7.5% Y5V: within ± 20% <p>* Q/D.F.:</p> <ul style="list-style-type: none"> NP0(COG)/X7R/Y5V: ≤1.0 × Initial * I.R. ≥ 0.25 × initial requirement <p>* I.R. ≥ 0.25 × initial requirements.</p>
Step	Temp. (°C)	Time(min)															
1	Min. operating temp.+0/-3	30±3															
2	Room temp.	2~3															
3	Max. operating temp.+3/-0	30±3															
4	Room temp.	2~3															

RELIABILITY TEST CONDITIONS AND REQUIREMENTS

ITEM	TEST CONDITION	REQUIREMENTS										
Humidity (Damp Heat) Load	<ul style="list-style-type: none"> * Test temp.: $40 \pm 2^{\circ} \text{C}$ * Humidity: 90~95%RH * Test time: 500+24/-0 hrs. * To apply voltage: rated voltage (Max. 500V) * Measurement to be made after keeping at room temp. for 24 ± 2 hrs. (Class I) or 48 ± 4 hrs. (Class II).. 	<ul style="list-style-type: none"> * No remarkable damage. * Cap change: NP0: within $\pm 7.5\%$ or $\pm 0.75\text{pF}$ whichever is larger. X7R: within $\pm 12.5\%$ Y5V: within $\pm 30\%$ * Q/D.F. value: NP0: $\text{Cap} \geq 30\text{pF}$, $\text{Q} \geq 200$; $\text{Cap} < 30\text{pF}$, $\text{Q} \geq 100 + 10/3\text{C}$ X7R: $\leq 3.0\%$ Y5V: $\leq 7.5\%$ * I.R.: $\geq 500\text{M}\Omega$ or $\text{RxC} \geq 25\Omega\text{-F}$ whichever is smaller. 										
High Temperature Load (Endurance)	<ul style="list-style-type: none"> * Test temp.: COG(NP0), X7R: $125 \pm 3^{\circ}\text{C}$ Y5V: $85 \pm 3^{\circ}\text{C}$ * To apply voltage: (1) $\text{UR} \leq 250\text{V}$: 200% of rated voltage. Exception item: UR Size Cap Voltage <table border="1" style="width: 100%; border-collapse: collapse; margin: 10px 0;"> <thead> <tr> <th>UR</th> <th>Size</th> <th>Cap.</th> <th>Voltage</th> </tr> </thead> <tbody> <tr> <td rowspan="2">200V/250V</td> <td>1210</td> <td>≥ 224</td> <td rowspan="2">1.5 times of UR</td> </tr> <tr> <td>1812</td> <td>≥ 474</td> </tr> </tbody> </table> <ul style="list-style-type: none"> (2) $250 < \text{UR} \leq 500\text{V}$: 150% of rated voltage. (3) $\text{UR} > 500\text{V}$: 120% of rated voltage. (4) 1206, NP0 $\geq 1.5\text{pF}$: 100% of rated voltage. * Test time: 1000+24/-0 hrs. * Measurement to be made after keeping at room temp. for 24 ± 2 hrs (Class I) or 48 ± 4 hrs (Class II). 	UR	Size	Cap.	Voltage	200V/250V	1210	≥ 224	1.5 times of UR	1812	≥ 474	<ul style="list-style-type: none"> * No remarkable damage. * Cap change: COG(NP0) : within $\pm 3\%$ or $\pm 0.3\text{pF}$ whichever is larger X7R : within $\pm 12.5\%$ Y5V : within $\pm 30\%$ * Q/D.F Value: COG(NP0): $\text{Cap} \geq 30\text{pF}$: $\text{Q} \geq 350$; $10\text{pF} \leq \text{Cap} < 30\text{pF}$: $\text{Q} \geq 275 + 2.5\text{C}$; $\text{Cap} < 10\text{pF}$: $\text{Q} \geq 200 + 10\text{C}$ X7R: $\leq 3.0\%$ Y5V: $\leq 7.5\%$ * I.R.: $\geq 1\text{G}\Omega$ or $\text{RxC} \geq 50\Omega\text{-F}$ whichever is smaller.
UR	Size	Cap.	Voltage									
200V/250V	1210	≥ 224	1.5 times of UR									
	1812	≥ 474										

RELIABILITY TEST CONDITIONS AND REQUIREMENTS

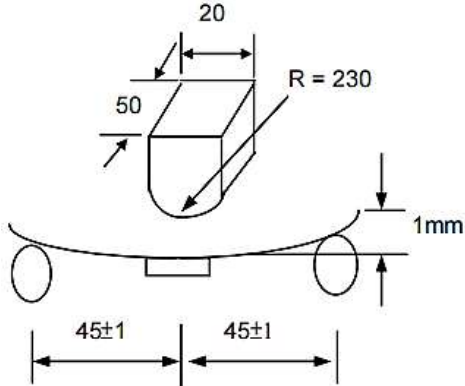
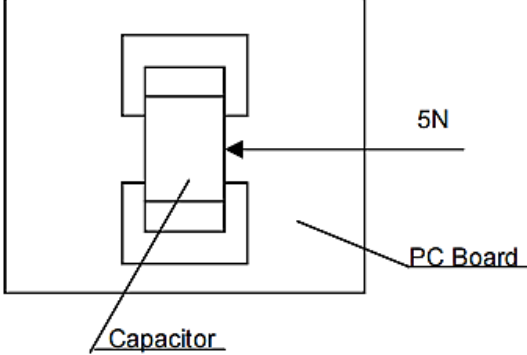
ITEM	TEST CONDITION	REQUIREMENTS
<p>Resistance to Flexure of Substrate</p>	<p>* The middle part of substrate shall be pressurized by means of the pressurizing rod at a rate of about 1mm per second until the deflection becomes 1 mm.</p> 	<p>* No remarkable damage. * Cap change: COG(NP0): within $\pm 5.0\%$ or $\pm 0.5\text{pF}$ whichever is larger. X7R: within $\pm 12.5\%$ Y5V: within $\pm 30\%$</p> <p>(This capacitance change means the change of capacitance under specified flexure of substrate from the capacitance measured before the test.)</p>
<p>Adhesive Strength of Termination</p>	<p>* Capacitors mounted on a substrate. A force of 5N(≤ 0603) or 10N(> 0603) applied perpendicular to the place of substrate and parallel the line joining the center of terminations for 10 ± 1 second.</p> 	<p>* No remarkable damage or removal of the terminations.</p>
<p>Vibration Resistance</p>	<p>* Vibration frequency: 10~55 Hz/min. * Total amplitude: 1.5mm * Test time: 6 hrs. (Two hrs each in three mutually perpendicular directions.)</p>	<p>* No remarkable damage. * Cap change and Q/D.F.: To meet initial spec.</p>

STORAGE AND HANDLING CONDITIONS

- To prevent the damage of solderability of terminations, the following storage conditions are recommended:
Indoors under 5 ~ 40°C and 20% ~ 70% RH.
- No harmful gases containing sulfuric acid, ammonia, hydrogen sulfide or chlorine.
- Packaging should not be opened until the capacitors are required for use. If opened, the pack should be re-sealed as soon as is practicable. Taped product should be stored out of direct sunlight, which might promote deterioration in tape or adhesion performance. The capacitors should be used within 6 months and checked the solderability before use.

HANDLING

- Chip capacitors are dense, hard, brittle, and abrasive materials. They are liable to suffer mechanical damage, in the form of cracks or chips. Chip Capacitors should be handled with care to avoid contamination or damage. To use vacuum or plastic tweezers to pick up or plastic tweezers is recommended for manual placement. Tape and reeled packages are suitable for automatic pick and placement machine.

PREHEAT

- In order to minimize the risk of thermal shock during soldering, a carefully controlled preheat is required. The rate of preheat should not exceed 4°C per second and the final preheat temperature should be within 100°C of the soldering temperature for small chips such as 0402, 0603, 0805 and 1206, within 50°C of the soldering temperature for bigger chips such as 1210, 1808, 1812, 1825, 2220 and 2225, etc.

SOLDERING – PART I

- Use rosin activated flux (RA and RMA) do not use activated flux. The amount of solder in each solder joint should be controlled to prevent the damage of chip capacitors caused by the stress between solder, chips, and substrate.
- Hand soldering with temperature-controlled iron not exceeding 30 watts and diameter of tip less than 1.2mm is recommended, tip of iron should not contact the ceramic body directly, and the temperature of iron should be set to not more than 260°C. For bigger chips such as 1210, 1808, 1812, 2220 and 2225, etc. wave soldering and hand soldering are not recommended.

SOLDERING – PART II

- Refer IPC/JEDEC J-STD-020D Method recommended soldering profiles :

Reflow not sooner than 15 minutes and not longer than 4 hrs after removal from the temperature/humidity chamber, subject the sample to 3 cycle of the appropriate reflow conditions as defined as blow Table description.

PROFILE FEATURE			PB-FREE ASSEMBLY
Preheat	Temperature Min	Ts Min.	150°C
	Temperature Max	Ts Max.	200°C
	Time	ts Min. to ts Max.	60 ~ 120 seconds
Ramp-up rate		TL to Tp	3 °C /Second Max.
Liquidous temperature		TL	217 °C
Time(tL) maintained above TL			60 to 150 seconds
Peak package body temperature		Tp	<ul style="list-style-type: none"> For user Tp must not exceed the Classification temp 260°C For suppliers Tp must equal or exceed the Classification temp 260°C
Time(Tp)* within 5 of the specified °C classification temperature(Tc)			30* seconds
Ramp-down rate		Tp to TL	6 °C /Second Max.
Time 25 °C to Peak Temperature			8 minutes Max.
Suggest reflow times			3 Times Max.

- Lead-free : Soldering temperature = 235 to 260°C, depending on product.
- Max. Temperature = Min. Temperature (235°C)+ΔT+ Tolerance for oven process and Measurement (5 ~ 7°C)
- Time at peak temperature = 10sec, Dwell above 217°C = 90sec, Ramping rate = 3°C/sec(heating) and 6 °C/sec (heating).

RECOMMENDED PROFILE CONDITIONS

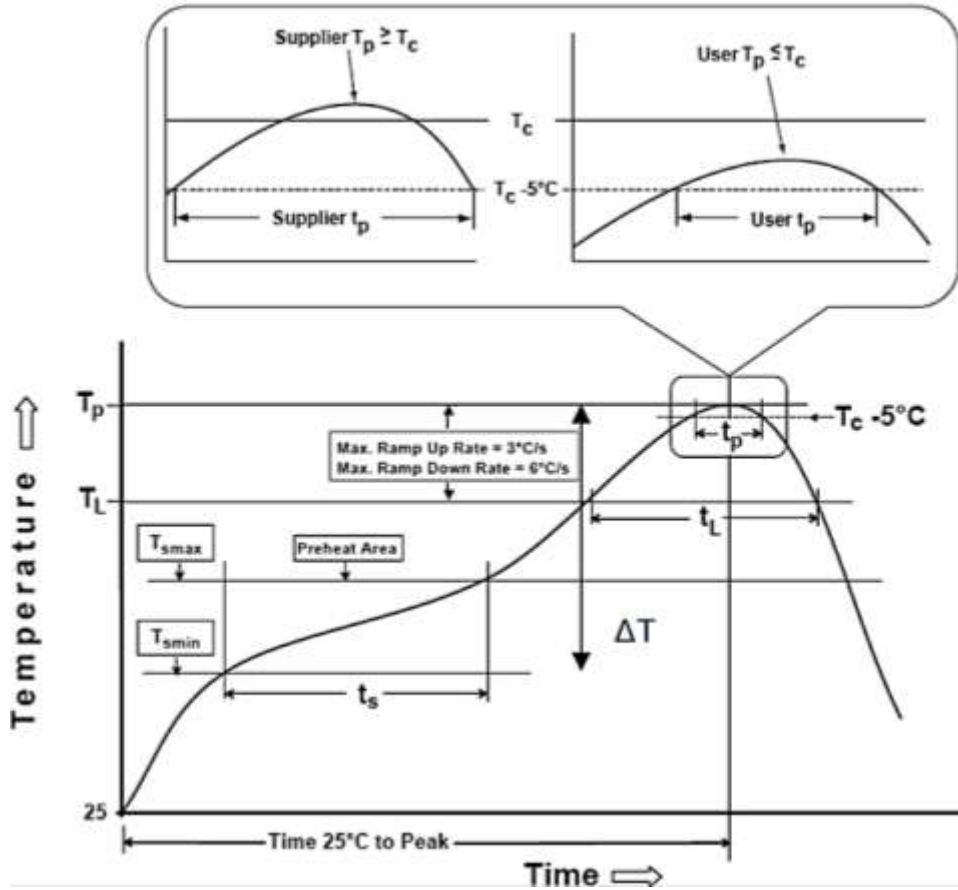

CHIP SIZE	ΔT
0402, 0603, 0805, 1206	100 °C
1210, 1808, 1812, 1825, 2211, 2220, 2225	50 °C

SOLDERING	SOLDER TIME (t)	SOLDERING TEMP. (t)
Reflow	235 – 260 °C	< 15 sec.
Wave	230 – 260 °C	< 5 sec.

Note :

- For example, T_c is 260°C and time t_p is 15sec.
- for user : The peak temperature must not exceed 260°C . The time above 255°C must not exceed 15 seconds.

COOLING

- After soldering, cool the chips and the substrate gradually to room temperature. Natural cooling in air is recommended to minimize stress in the solder joint. A cooling rate not exceeding 4°C per second should be used when forced cooling is necessary.

CLEANING

- All flux residues must be removed by using suitable electronic-grade vapor-cleaning solvents to eliminate contamination that could cause electrolytic surface corrosion. Good results can be obtained by using ultrasonic cleaning of the solvent. The choice of the proper system is depends upon many factors such as component mix, flux, and solder paste and assembly method. The ability of the cleaning system to remove flux residues and contamination from under the chips is very important.

TAPE DIMENSION (Unit: mm)

Paper Tape

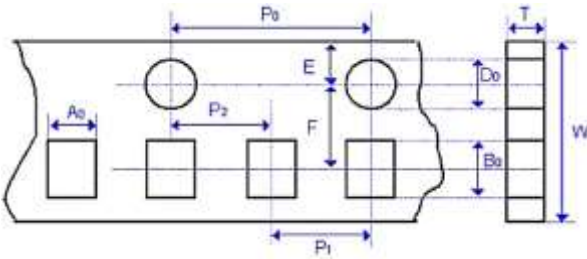

Plastic Tape

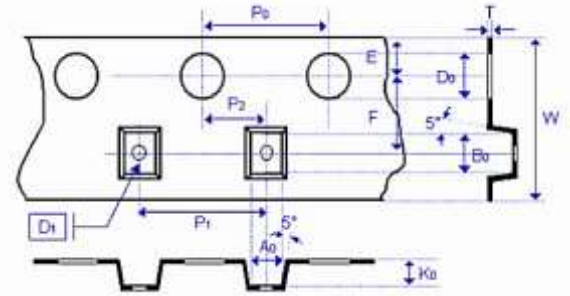

SIZE	0201	0402	0603
Thickness	L	H	H, S, B, X
A0	0.40 ± 0.10	0.70 ± 0.20	1.05 ± 0.30
B0	0.70 ± 0.10	1.20 ± 0.20	1.80 ± 0.30
T	≤ 0.55	≤ 0.80	≤ 1.20
K0	-	-	-
W	8.00 ± 0.30	8.00 ± 0.30	8.00 ± 0.30
P0	4.00 ± 0.10	4.00 ± 0.10	4.00 ± 0.10
10xP0	40.00 ± 0.10	40.00 ± 0.10	40.00 ± 0.20
P1	2.00 ± 0.05	2.00 ± 0.05	4.00 ± 0.10
P2	2.00 ± 0.05	2.00 ± 0.05	2.00 ± 0.05
D0	1.50 + 0.1 / - 0	1.50 + 0.1 / - 0	1.50 + 0.1 / - 0
D1	-	-	-
E	1.75 ± 0.10	1.75 ± 0.10	1.75 ± 0.10
F	3.50 ± 0.05	3.50 ± 0.05	3.50 ± 0.05

TAPE DIMENSION (Unit: mm)

SIZE	0805			1206		
	A, H	B, X	C	B	I, C, J	D, P
Thickness						
A0	1.50±0.20	1.50±0.20	<1.80	1.90±0.50	< 2.00	<2.30
B0	2.30±0.20	2.30±0.20	< 2.70	3.50±0.50	< 3.70	< 4.00
T	≤1.15	≤1.20	0.23±0.1	≤1.20	0.23±0.1	0.23±0.1
K0	-	-	< 2.50	-	< 2.50	< 2.50
W	8.00±0.30	8.00±0.30	8.00±0.30	8.00±0.30	8.00±0.30	8.00±0.30
P0	4.00±0.10	4.00±0.10	4.00±0.10	4.00±0.10	4.00±0.10	4.00±0.10
10xP0	40.00±0.20	40.00±0.20	40.00±0.20	40.00±0.20	40.00±0.20	40.00±0.20
P1	4.00±0.10	4.00±0.10	4.00±0.10	4.00±0.10	4.00±0.10	4.00±0.10
P2	2.00±0.05	2.00±0.05	2.00±0.05	2.00±0.05	2.00±0.05	2.00±0.05
D0	1.50+0.1/-0	1.50+0.1/-0	1.50+0.1/-0	1.50+0.1/-0	1.50+0.1/-0	1.50+0.1/-0
D1	-	-	1.00±0.10	-	1.00±0.10	1.00±0.10
E	1.75±0.10	1.75±0.10	1.75±0.10	1.75±0.10	1.75±0.10	1.75±0.10
F	3.50±0.05	3.50±0.05	3.50±0.05	3.50±0.05	3.50±0.05	3.50±0.05

TAPE DIMENSION (Unit: mm)

SIZE	1210			1812	
	B	I, C, D, K	M	C, D, K	M, U
Thickness					
A0	< 3.05	< 3.05	< 3.20	< 3.90	< 3.90
B0	< 3.80	< 3.80	<4.00	< 5.30	< 5.30
T	0.23±0.1	0.23±0.1	0.23±0.1	0.25±0.1	0.25±0.1
K0	< 1.50	< 2.50	< 3.20	< 2.50	< 3.50
W	8.00±0.30	8.00±0.30	8.00±0.30	12.00±0.30	12.00±0.30
P0	4.00±0.10	4.00±0.10	4.00±0.10	4.00±0.10	4.00±0.10
10xP0	40.00±0.20	40.00±0.20	40.00±0.20	40.00±0.20	40.00±0.20
P1	4.00±0.10	4.00±0.10	4.00±0.10	8.00±0.10	8.00±0.10
P2	2.00±0.05	2.00±0.05	2.00±0.05	2.00±0.10	2.00±0.10
D0	1.50+0.1/-0	1.50+0.1/-0	1.50+0.1/-0	1.50+0.1/-0	1.50+0.1/-0
D1	1.00±0.10	1.00±0.10	1.00±0.10	1.50±0.10	1.50±0.10
E	1.75±0.10	1.75±0.10	1.75±0.10	1.75±0.10	1.75±0.10
F	3.50±0.05	3.50±0.05	3.50±0.05	5.50±0.10	5.50±0.10

TAPE DIMENSION (Unit: mm)

SIZE	1825		2220		2225	
Thickness	K	M, U	K	M, U	K	M, U
A0	< 6.80	< 6.80	< 5.80	< 5.80	< 6.80	< 6.80
B0	< 5.30	< 5.30	< 6.50	< 6.50	< 6.50	< 6.50
T	0.30 +/-0.1	0.30 +/-0.1	0.30 +/-0.1	0.30 +/-0.1	0.30 +/-0.1	0.30 +/-0.1
K0	< 2.50	< 3.50	< 2.50	< 3.50	< 2.50	< 3.50
W	12+/-0.30	12+/-0.30	12+/-0.30	12+/-0.30	12+/-0.30	12+/-0.30
P0	4.00 +/-0.10	4.00 +/-0.10	4.00 +/-0.10	4.00 +/-0.10	4.00 +/-0.10	4.00 +/-0.10
10xP0	40.0 +/-0.20	40.0 +/-0.20	40.0 +/-0.20	40.0 +/-0.20	40.0 +/-0.20	40.0 +/-0.20
P1	8.00 +/-0.10	8.00 +/-0.10	8.00 +/-0.10	8.00 +/-0.10	8.00 +/-0.10	8.00 +/-0.10
P2	2.00 +/-0.10	2.00 +/-0.10	2.00 +/-0.10	2.00 +/-0.10	2.00 +/-0.10	2.00 +/-0.10
D0	1.50 +0.1/-0	1.50 +0.1/-0	1.50 +0.1/-0	1.50 +0.1/-0	1.50 +0.1/-0	1.50 +0.1/-0
D1	1.50 +/-0.10	1.50 +/-0.10	1.50 +/-0.10	1.50 +/-0.10	1.50 +/-0.10	1.50 +/-0.10
E	1.75 +/-0.10	1.75 +/-0.10	1.75 +/-0.10	1.75 +/-0.10	1.75 +/-0.10	1.75 +/-0.10
F	5.50 +/-0.10	5.50 +/-0.10	5.50 +/-0.10	5.50 +/-0.10	5.50 +/-0.10	5.50 +/-0.10

REEL DIMENSION (Unit: mm)

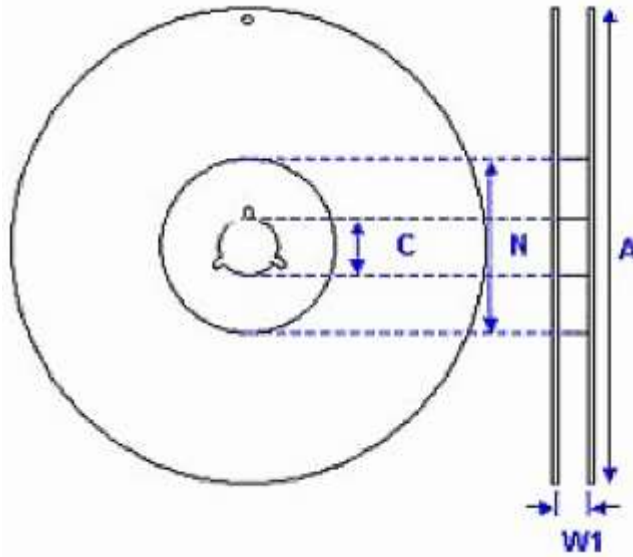

SIZE CODE	0201, 0402, 0603, 0805, 1206, 1210, 1812			1808, 1812, 1825, 2220, 2225
Reel Size	7"	10"	13"	7"
C	13.0+0.5/-0.2	13.0+0.5/-0.2	13.0+0.5/-0.2	13.0+0.5/-0.2
W 1	8.4+1.5/-0	8.4+1.5/-0	8.4+1.5/-0	12.4+2.0/-0
A	178.0±0.10	250.0±1.0	330.0±1.0	178.0±0.10
N	60.0+1.0/-0	100.0±1.0	100.0±1.0	60.0+1.0/-0

PACKAGING STYLE AND QUANTITY OER REEL

SIZE	THICKNESS (SYMBOL)		PAPER TAPE		PLASTIC TAPE	
			7" REEL	13" REEL	7" REEL	13" REEL
0402 (1005)	0.50±0.05	N	10,000	50,000	-	-
0603 (1608)	0.80±0.10	S	4,000	15,000	-	-
	0.80±0.20	X	4,000	15,000		
0805 (2012)	0.60±0.10	A	4,000	15,000	-	-
	0.85±0.15	B	4,000	15,000	-	-
	1.25±0.10	D	-	-	3,000	10,000
	1.25±0.20	I	-	-	3,000	10,000
1206 (3216)	0.85±0.15	B	4,000	15,000	-	-
	0.95±0.10	C	-	-	3,000	10,000
	1.25±0.10	D	-	-	3,000	10,000
	1.60±0.20	G	-	-	2,000	10,000
	1.60+0.30/-0.10	P	-	-	2,000	9,000
1210 (3225)	0.95±0.10	C	-	-	3,000	10,000
	1.25±0.10	D	-	-	3,000	10,000
	1.60±0.20	G	-	-	2,000	-
	2.00±0.20	K	-	-	1,000	6,000
	2.50±0.30	M	-	-	1,000	6,000
1808 (4520)	1.25±0.10	D	-	-	2,000	10,000
	1.60±0.20	G	-	-	2,000	8,000
	2.00±0.20	K	-	-	1,000	6,000
1812 (4532)	1.25±0.10	D	-	-	1,000	5,000
	1.60±0.20	G	-	-	1,000	-
	2.00±0.20	K	-	-	1,000	-
	2.50±0.30	M	-	-	500	3,000

PACKAGING STYLE AND QUANTITY OER REEL

SIZE	THICKNESS (SYMBOL)		PAPER TAPE		PLASTIC TAPE	
			7" REEL	13" REEL	7" REEL	13" REEL
1825 (4563) 2220 (5750) 2225 (5763)	2.00±0.20	K	-	-	1,000	-
	2.50±0.30	M	-	-	500	-
	2.80±0.30	U	-	-	500	-

IMPORTANT NOTES AND DISCLAIMER

1. **ROHS COMPLIANCE:** The levels of RoHS restricted materials in this product are below the maximum concentration values (also referred to as the threshold limits) permitted for such substances, or are used in an exempted application, in accordance with EU RoHS Directive (EU) 2015/863 EC (RoHS3). RoHS Test Report for this product can be obtained at Download Center.
2. **REACH COMPLIANCE:** REACH substances of high concern (SVHCs) information is available for this product. Since the European Chemical Agency (ECHA) has published notice of their intent to frequently revise the SVHC listing for the foreseeable future, REACH Test Report for this product can be obtained at Download Center.
3. All Product parametric performance is indicated in the Electrical Characteristics for the listed herein test conditions, unless otherwise noted. Product performance may not be indicated by the Electrical Characteristics if operated under different conditions.
4. NextGen Component, Inc (*NextGen*) reserves the right to make changes to this document and its products and specifications at any time without notice. Customers should obtain and confirm the latest product information and specifications before final design, purchase or use.
5. *NextGen* makes no warranty, representation or guarantee regarding the suitability of its products for any particular purpose, not does *NextGen* assume any liability for application assistance or customer product design.
6. *NextGen* does not warrant or accept any liability with products which are purchased or used for any unintended or unauthorized application. No license is granted by implication or otherwise under any intellectual property rights of NextGen.
7. *NextGen* products are not authorized for use as critical components in life support devices or systems without express written approval by *NextGen*.
8. *NextGen* requires that customers first obtain an RMA (Returned Merchandise Authorization) number prior to returning any products. Returns must be made within 30 days of the date of invoice, be in the original packaging, unused and like-new condition. At the time of quoting or purchasing, a product may say that it is Non-Cancelable/ Non-Returnable (NCNR). These products are not returnable and not refundable.