



<b>SPECIFICATION SHEET NO.</b>	R1212- 0201W105M100LE	
<b>ORIGINAL MFG/PART NO.</b>	Aillen Capacitors/0201W105M100LE	
<b>NEXTGEN PART CODE</b>	0201W105M100LE	Indicate This Code For <a href="#">RFQ</a> /Order
<b>DATE</b>	Dec. 12, 2024	
<b>REVISION</b>	A9	Updated With Most Recent Data
<b>DESCRIPTION AND MAIN PARAMETRICS</b>	<p>Low Voltage Multilayer Ceramic Chip Capacitors (MLCC), 0201 Series            Case 0603 Metric 0201, Dimension L0.60*W0.30*H0.30mm            Thickness: 0.39mm Max. Dielectric X5R, Capacitance 1<math>\mu</math>F, Tolerance <math>\pm</math>20%            Rated Voltage 10V            Operating Temp. Range -55°C ~+85°C            Package in Tape/Reel, 15,000pcs/Reel            REACH/RoHS/RoHS III Compliant</p>	
<b>CUSTOMER</b>		
<b>CUSTOMER PART NUMBER</b>		
<b>CROSS REF. PART NUMBER</b>		
<b>MEMO</b>		

<b>VENDOR APPROVE</b>		
Issued/Checked/Approved		
		
Effective Date: Dec. 12, 2024		

<b>CUSTOMER APPROVE</b>
DATE:

## DESCRIPTION

MLCC consists of a conducting material and electrodes. To manufacture a chip-type SMT and achieve miniaturization, high density and high efficiency, ceramic condensers are used. MLCC is made by NP0 (COG), X7R, X5R And X6S dielectric material and which provides product with high electrical precision, stability and reliability.



*Image shown is a representation only.*

*Exact specifications should be obtained from the product dimension.*

## MAIN FEATURE

- A Wide Selection Of Size Is Available
- Rated Voltage Range 6.3V ~ 100V
- High Capacitance In Given Case Size
- Temperature Characteristics: NP0 (COG), X7R, X5R and X6S
- Capacitor With Lead-free Termination (Pure Tin)
- REACH/RoHS/RoHS III Compliant



## APPLICATION

- General Digital Circuit
- Power Supply by pass capacitors
- Consumer Electronics
- Telecommunication

## ELECTRICAL CHARACTERISTICS

- See Page 4 ~Page 25 For Different Part Code And Rated Voltage.
- All Products Parameters are Subject To NextGen Components' Final Confirmation.

**HOW TO ORDER**

- Please Follow Up Part Code Guide And Indicate NextGen Part Code 0201W105M100LE For RFQ and Order.

**RFQ**  
Request For Quotation

**PART CODE GUIDE**

CODE	NAME	KEY SPECIFICATION OPTION
0201	Size	0201 (0603 Metric): L0.60*W0.30mm; 0402 (1005 Metric): L1.00*W0.50mm 0603 (1608 Metric ): L1.60*W0.80mm; 0805 (2012 Metric): L2.00*W1.25mm 1206 (3216 Metric): L3.20*W1.60mm; 1210 (3225 Metric): L3.20*W2.50mm 1812 (4532 Metric): L4.50*W3.20mm; 1825 (4563 Metric):L4.50*W6.30mm 2220 (5750 Metric): L5.70*W5.00mm; 2225 (5763 Metric ): L5.70*W6.30mm
W	Temperature Coefficient	N: NPO (COG); B: X7R; W: X5R; S: X6S
105	Capacitance	Two significant digits followed by number of Zero, The 3rd digit signifies the multiplying factor, and letter R is decimal point. 8R2: 8.2pF; 331: 330pF; 102: 1000pF; 101: 100pF; 330: 33pF; 105: 1μF
M	Tolerance	A: ±0.05pF; B: ±0.1pF; C: ±0.25pF; D: ±0.5pF; F: ±1%; G: ±2%; J: ±5%; K: ±10% M: ±20% ; Z: -20/+80%
100	Rated Voltage	Two significant digits followed by No. of zeros. “R” is in place of decimal point. 4R0: 4.0VDC; 6R3: 6.3VDC; 100: 10VDC; 160: 16 VDC; 250: 25 VDC; 500: 50 VDC; 101: 100VDC
L	Thickness	L: 0.30 ± 0.09mm, See Page 26 ~ page 28 (T’s Symbol) for Different part code
E	Package	A: 1Kpcs/Reel; B: 2Kpcs/Reel; C: 3Kpcs/Reel; D: 4Kpcs/Reel; E: 15Kpcs/Reel; I: 10Kpcs/Reel; J: 2.5Kpcs/Reel; K: 0.5 Kpcs/Reel
( )	Internal Control	Blank: N/A; XX: Letter A~Z, a~z or digits (0~9) for Special/Custom Parameters

**ELECTRICAL CHARACTERISTICS** – 6.3V X5R FOR DIFFERENT PART CODE

NEXTGEN PART CODE	TEMP. COEFFICIENT	CAPACITANCE	TOLERANCE	VOLTAGE	THICKNESS (MAX.)	OPERATING TEMP. RANGE	CAPACITANCE CHARACTERISTIC
	-	-	-	V	mm	°C	-
0201W104K6R3LE	X5R	0.1 $\mu$ F	$\pm 10\%$	6.3	0.39	-55 ~+85	$\pm 15\%$
0201W105K6R3LE	X5R	1 $\mu$ F	$\pm 10\%$	6.3	0.39	-55 ~+85	$\pm 15\%$
0201W105M6R3LE	X5R	1 $\mu$ F	$\pm 20\%$	6.3	0.39	-55 ~+85	$\pm 15\%$
0402W105K6R3HI	X5R	1 $\mu$ F	$\pm 10\%$	6.3	0.70	-55 ~+85	$\pm 15\%$
0402W105M6R3HI	X5R	1 $\mu$ F	$\pm 20\%$	6.3	0.70	-55 ~+85	$\pm 15\%$
0402W106M6R3HI	X5R	10 $\mu$ F	$\pm 20\%$	6.3	0.70	-55 ~+85	$\pm 15\%$
0402W224K6R3HI	X5R	0.22 $\mu$ F	$\pm 10\%$	6.3	0.70	-55 ~+85	$\pm 15\%$
0402W225K6R3HI	X5R	2.2 $\mu$ F	$\pm 10\%$	6.3	0.70	-55 ~+85	$\pm 15\%$
0402W225M6R3HI	X5R	2.2 $\mu$ F	$\pm 20\%$	6.3	0.70	-55 ~+85	$\pm 15\%$
0402W475M6R3HI	X5R	4.7 $\mu$ F	$\pm 20\%$	6.3	0.70	-55 ~+85	$\pm 15\%$
0603W106K6R3XD	X5R	10 $\mu$ F	$\pm 10\%$	6.3	1.00	-55 ~+85	$\pm 15\%$
0603W106M6R3XD	X5R	10 $\mu$ F	$\pm 20\%$	6.3	1.00	-55 ~+85	$\pm 15\%$
0603W225K6R3XD	X5R	2.2 $\mu$ F	$\pm 10\%$	6.3	1.00	-55 ~+85	$\pm 15\%$
0603W226M6R3XD	X5R	22 $\mu$ F	$\pm 20\%$	6.3	1.00	-55 ~+85	$\pm 15\%$
0603W475K6R3XD	X5R	4.7 $\mu$ F	$\pm 10\%$	6.3	1.00	-55 ~+85	$\pm 15\%$
0603W475M6R3XD	X5R	4.7 $\mu$ F	$\pm 20\%$	6.3	1.00	-55 ~+85	$\pm 15\%$
0805W106K6R3CC	X5R	10 $\mu$ F	$\pm 10\%$	6.3	1.45	-55 ~+85	$\pm 15\%$
0805W226M6R3CC	X5R	22 $\mu$ F	$\pm 20\%$	6.3	1.45	-55 ~+85	$\pm 15\%$
0805W476M6R3CC	X5R	47 $\mu$ F	$\pm 20\%$	6.3	1.45	-55 ~+85	$\pm 15\%$
1206W107M6R3PB	X5R	100 $\mu$ F	$\pm 20\%$	6.3	1.90	-55 ~+85	$\pm 15\%$

**ELECTRICAL CHARACTERISTICS** – 10V X5R & X7R FOR DIFFERENT PART CODE

NEXTGEN PART CODE	TEMP. COEFFICIENT	CAPACITANCE	TOLERANCE	VOLTAGE	THICKNESS (MAX.)	OPERATING TEMP. RANGE	CAPACITANCE CHARACTERISTIC
	-	-	-	V	mm	°C	-
0201W104K100LE	X5R	0.1 µF	±10%	10	0.39	-55 ~+85	±15%
<a href="#">0201W105M100LE</a>	X5R	1 µF	±20%	10	0.39	-55 ~+85	±15%
0402W104K100HI	X5R	0.1 µF	±10%	10	0.70	-55 ~+85	±15%
0402W105K100HI	X5R	1 µF	±10%	10	0.70	-55 ~+85	±15%
0402W106M100HI	X5R	10 µF	±20%	10	0.70	-55 ~+85	±15%
0402W224K100HI	X5R	0.22 µF	±10%	10	0.70	-55 ~+85	±15%
0402W225K100HI	X5R	2.2 µF	±10%	10	0.70	-55 ~+85	±15%
0603B105K100XD	X7R	1 µF	±10%	10	1.00	-55 ~+125	±15%
0603B225K100XD	X7R	2.2 µF	±10%	10	1.00	-55 ~+125	±15%
0603W105K100XD	X5R	1 µF	±10%	10	1.00	-55 ~+85	±15%
0603W106M100XD	X5R	10 µF	±20%	10	1.00	-55 ~+85	±15%
0603W225K100XD	X5R	2.2 µF	±10%	10	1.00	-55 ~+85	±15%
0603W226M100BD	X5R	22 µF	±20%	10	1.00	-55 ~+85	±15%
0603W335K100XD	X5R	3.3 µF	±10%	10	1.00	-55 ~+85	±15%
0603W475K100XD	X5R	4.7 µF	±10%	10	1.00	-55 ~+85	±15%
0603W475M100XD	X5R	4.7 µF	±20%	10	1.00	-55 ~+85	±15%
0805B105K100CC	X7R	1.0 µF	±10%	10	1.45	-55 ~+125	±15%
0805W226M100CC	X5R	22 µF	±20%	10	1.45	-55 ~+85	±15%
0805B475K100CC	X7R	4.7 µF	±10%	10	1.45	-55 ~+125	±15%
1206B475K100PB	X7R	4.7 µF	±10%	10	1.90	-55 ~+125	±15%



**ELECTRICAL CHARACTERISTICS – 16V X5R & X7R FOR DIFFERENT PART CODE**

NEXTGEN PART CODE	TEMP. COEFFICIENT	CAPACITANCE	TOLERANCE	VOLTAGE	THICKNESS (MAX.)	OPERATING TEMP. RANGE	CAPACITANCE CHARACTERISTIC
	-	-	-	V	mm	°C	-
0402B104K160HI	X7R	0.1 µF	±10%	16	0.70	-55 ~+125	±15%
0402B223K160HI	X7R	0.022 µF	±10%	16	0.70	-55 ~+125	±15%
0402W105K160HI	X5R	1 µF	±10%	16	0.70	-55 ~+85	±15%
0603W106M160XD	X5R	10 µF	±20%	16	1.00	-55 ~+85	±15%
0603B105K160XD	X7R	1 µF	±10%	16	1.00	-55 ~+125	±15%
0603B224K160SD	X7R	0.22 µF	±10%	16	0.90	-55 ~+125	±15%
0603W105K160XD	X5R	1 µF	±10%	16	1.00	-55 ~+85	±15%
0603W106K160XD	X5R	10 µF	±10%	16	1.00	-55 ~+85	±15%
0603W225K160XD	X5R	2.2 µF	±10%	16	1.00	-55 ~+85	±15%
0603W475K160XD	X5R	4.7 µF	±10%	16	1.00	-55 ~+85	±15%
0805B105K160CC	X7R	1.0 µF	±10%	16	1.45	-55 ~+125	±15%
0805B225K160CC	X7R	2.2 µF	±10%	16	1.45	-55 ~+125	±15%
0805B475K160CC	X7R	4.7 µF	±10%	16	1.45	-55 ~+125	±15%
1206B105K160JC	X7R	1 µF	±10%	16	1.35	-55 ~+125	±15%
1206W106K160PB	X5R	10 µF	±10%	16	1.90	-55 ~+85	±15%
1206W226K160PB	X5R	22 µF	±10%	16	1.90	-55 ~+85	±15%
1210B106K160KA	X7R	10 µF	±10%	16	2.20	-55 ~+125	±15%
1210B226K160MA	X7R	22 µF	±10%	16	2.80	-55 ~+125	±15%
1210B226M160MA	X7R	22 µF	±20%	16	2.80	-55 ~+125	±15%
1210B475K160KA	X7R	4.7 µF	±10%	16	2.20	-55 ~+125	±15%





**ELECTRICAL CHARACTERISTICS – 25V NP0 (COG), X5R & X7R FOR DIFFERENT PART CODE**

NEXTGEN PART CODE	TEMP. COEFFICIENT	CAPACITANCE	TOLERANCE	VOLTAGE	THICKNESS (MAX.)	OPERATING TEMP. RANGE	CAPACITANCE CHARACTERISTIC
	-	-	-	V	mm	°C	-
0201N100J250LE	NP0 (COG)	10 pF	±5%	25	0.39	-55 ~+125	±30ppm
0201N101J250LE	NP0 (COG)	100 pF	±5%	25	0.39	-55 ~+125	±30ppm
0201N6R8C250LE	NP0 (COG)	6.8 pF	±0.25pF	25	0.39	-55 ~+125	±30ppm
0402B102K250HI	X7R	1000 pF	±10%	25	0.70	-55 ~+125	±15%
0402B104K250HI	X7R	0.1 µF	±10%	25	0.70	-55 ~+125	±15%
0402B123K250HI	X7R	0.012 µF	±10%	25	0.70	-55 ~+125	±15%
0402B473K250HI	X7R	0.047 µF	±10%	25	0.70	-55 ~+125	±15%
0402N102J250HI	NP0 (COG)	1000 pF	±5%	25	0.70	-55 ~+125	±30ppm
0402W224K250HI	X5R	0.22 µF	±10%	25	0.70	-55 ~+85	±15%
0603B101K250SD	X7R	100 pF	±10%	25	0.90	-55 ~+125	±15%
0603B104J250SD	X7R	0.1 µF	±5%	25	0.90	-55 ~+125	±15%
0603B104K250SD	X7R	0.1 µF	±10%	25	0.90	-55 ~+125	±15%
0603B105K250XD	X7R	1 µF	±10%	25	1.00	-55 ~+125	±15%
0603B223K250SD	X7R	0.022 µF	±10%	25	0.90	-55 ~+125	±15%
0603B224K250SD	X7R	0.22 µF	±10%	25	0.90	-55 ~+125	±15%
0603B224K250XD	X7R	0.22 µF	±10%	25	1.00	-55 ~+125	±15%
0603B472K250SD	X7R	4700 pF	±10%	25	0.90	-55 ~+125	±15%
0603W105K250BD	X5R	1 µF	±10%	25	1.00	-55 ~+85	±15%
0603W105K250XD	X5R	1 µF	±10%	25	1.00	-55 ~+85	±15%
0603W106M250XD	X5R	10 µF	±20%	25	1.00	-55 ~+85	±15%

**ELECTRICAL CHARACTERISTICS** – 25V X5R & X7R FOR DIFFERENT PART CODE

NEXTGEN PART CODE	TEMP. COEFFICIENT	CAPACITANCE	TOLERANCE	VOLTAGE	THICKNESS (MAX.)	OPERATING TEMP. RANGE	CAPACITANCE CHARACTERISTIC
	-	-	-	V	mm	°C	-
0603W225K250XD	X5R	2.2 $\mu$ F	$\pm$ 10%	25	1.00	-55 ~+85	$\pm$ 15%
0603W475K250XD	X5R	4.7 $\mu$ F	$\pm$ 10%	25	1.00	-55 ~+85	$\pm$ 15%
0805B105J250CC	X7R	1.0 $\mu$ F	$\pm$ 5%	25	1.45	-55 ~+125	$\pm$ 15%
0805B105K250CC	X7R	1.0 $\mu$ F	$\pm$ 10%	25	1.45	-55 ~+125	$\pm$ 15%
0805B225K250CC	X7R	2.2 $\mu$ F	$\pm$ 10%	25	1.45	-55 ~+125	$\pm$ 15%
0805B333K250BD	X7R	0.033 $\mu$ F	$\pm$ 10%	25	1.00	-55 ~+125	$\pm$ 15%
0805B334K250CC	X7R	0.33 $\mu$ F	$\pm$ 10%	25	1.45	-55 ~+125	$\pm$ 15%
0805B475K250CC	X7R	4.7 $\mu$ F	$\pm$ 10%	25	1.45	-55 ~+125	$\pm$ 15%
0805B684K250CC	X7R	0.68 $\mu$ F	$\pm$ 10%	25	1.45	-55 ~+125	$\pm$ 15%
0805W106K250CC	X5R	10 $\mu$ F	$\pm$ 10%	25	1.45	-55 ~+85	$\pm$ 15%
0805W225K250CC	X5R	2.2 $\mu$ F	$\pm$ 10%	25	1.45	-55 ~+85	$\pm$ 15%
0805W475K250CC	X5R	4.7 $\mu$ F	$\pm$ 10%	25	1.45	-55 ~+85	$\pm$ 15%
1206B105K250JC	X7R	1 $\mu$ F	$\pm$ 10%	25	1.35	-55 ~+125	$\pm$ 15%
1206B106K250PB	X7R	10 $\mu$ F	$\pm$ 10%	25	1.90	-55 ~+125	$\pm$ 15%
1206W106K250PB	X5R	10 $\mu$ F	$\pm$ 10%	25	1.90	-55 ~+85	$\pm$ 15%
1206W226K250PB	X5R	22 $\mu$ F	$\pm$ 10%	25	1.90	-55 ~+85	$\pm$ 15%
1210B106K250KA	X7R	10 $\mu$ F	$\pm$ 10%	25	2.20	-55°C ~ 125	$\pm$ 15%
1210B226K250YA	X7R	22 $\mu$ F	$\pm$ 10%	25	1.90	-55°C ~ 125	$\pm$ 15%
1210B226M250MA	X7R	22 $\mu$ F	$\pm$ 20%	25	2.80	-55°C ~ 125	$\pm$ 15%
1210B474K250IC	X7R	0.47 $\mu$ F	$\pm$ 10%	25	1.05	-55°C ~ 125	$\pm$ 15%

**ELECTRICAL CHARACTERISTICS – 25V X5R & X7R FOR DIFFERENT PART CODE**

NEXTGEN PART CODE	TEMP. COEFFICIENT	CAPACITANCE	TOLERANCE	VOLTAGE	THICKNESS (MAX.)	OPERATING TEMP. RANGE	CAPACITANCE CHARACTERISTIC
	-	-	-	V	mm	°C	-
1210B475K250KA	X7R	4.7 μF	±10%	25	2.20	-55°C ~ 125	±15%
1210W106M250KA	X5R	10 μF	±20%	25	2.20	-55 ~+85	±15%
1210W226K250MA	X5R	22 μF	±10%	25	2.80	-55 ~+85	±15%
1210W475K250KA	X5R	4.7 μF	±10%	25	2.20	-55 ~+85	±15%

**ELECTRICAL CHARACTERISTICS** – 50V NP0 (COG) & X7R FOR DIFFERENT PART CODE

NEXTGEN PART CODE	TEMP. COEFFICIENT	CAPACITANCE	TOLERANCE	VOLTAGE	THICKNESS (MAX.)	OPERATING TEMP. RANGE	CAPACITANCE CHARACTERISTIC
	-	-	-	V	mm	°C	-
0201N100J500LE	NP0 (COG)	10 pF	±5%	50	0.39	-55 ~+125	±30ppm
0201N151J500LE	NP0 (COG)	150 pF	±5%	50	0.39	-55 ~+125	±30ppm
0201N330J500LE	NP0 (COG)	33 pF	±5%	50	0.39	-55 ~+125	±30ppm
0201N3R0C500LE	NP0 (COG)	3 pF	±0.25pF	50	0.39	-55 ~+125	±30ppm
0201N3R3B500LE	NP0 (COG)	3.3 pF	±0.1pF	50	0.39	-55 ~+125	±30ppm
0201N4R0C500LE	NP0 (COG)	4 pF	±0.25pF	50	0.39	-55 ~+125	±30ppm
0201N6R2C500LE	NP0 (COG)	6.2 pF	±0.25pF	50	0.39	-55 ~+125	±30ppm
0402B104K500HI	X7R	0.1 μF	±10%	50	0.70	-55 ~+125	±15%
0402B102K500HI	X7R	1000 pF	±10%	50	0.70	-55 ~+125	±15%
0402B103K500HI	X7R	0.01 μF	±10%	50	0.70	-55 ~+125	±15%
0402B223K500HI	X7R	0.022 μF	±10%	50	0.70	-55 ~+125	±15%
0402B682K500HI	X7R	6800 pF	±10%	50	0.70	-55 ~+125	±15%
0402N0R3B500HI	NP0 (COG)	0.3 pF	±0.1pF	50	0.70	-55 ~+125	±30ppm
0402N0R8B500HI	NP0 (COG)	0.8 pF	±0.1pF	50	0.70	-55 ~+125	±30ppm
0402N0R9B500HI	NP0 (COG)	0.9 pF	±0.1pF	50	0.70	-55 ~+125	±30ppm
0402N100J500HI	NP0 (COG)	10 pF	±5%	50	0.70	-55 ~+125	±30ppm
0402N101J500HI	NP0 (COG)	100 pF	±5%	50	0.70	-55 ~+125	±30ppm
0402N180J500HI	NP0 (COG)	18 pF	±5%	50	0.70	-55 ~+125	±30ppm
0402N1R0A500HI	NP0 (COG)	1 pF	±0.05pF	50	0.70	-55 ~+125	±30ppm
0402N1R0B500HI	NP0 (COG)	1 pF	±0.1pF	50	0.70	-55 ~+125	±30ppm

**ELECTRICAL CHARACTERISTICS – 50V NP0 (COG) FOR DIFFERENT PART CODE**

NEXTGEN PART CODE	TEMP. COEFFICIENT	CAPACITANCE	TOLERANCE	VOLTAGE	THICKNESS (MAX.)	OPERATING TEMP. RANGE	CAPACITANCE CHARACTERISTIC
	-	-	-	V	mm	°C	-
0402N1R0C500HI	NP0 (COG)	1 pF	±0.25pF	50	0.70	-55 ~+125	±30ppm
0402N1R2A500HI	NP0 (COG)	1.2 pF	±0.05pF	50	0.70	-55 ~+125	±30ppm
0402N1R2B500HI	NP0 (COG)	1.2 pF	±0.1pF	50	0.70	-55 ~+125	±30ppm
0402N1R2C500HI	NP0 (COG)	1.2 pF	±0.25pF	50	0.70	-55 ~+125	±30ppm
0402N1R3A500HI	NP0 (COG)	1.3 pF	±0.05pF	50	0.70	-55 ~+125	±30ppm
0402N1R3B500HI	NP0 (COG)	1.3 pF	±0.1pF	50	0.70	-55 ~+125	±30ppm
0402N1R5C500HI	NP0 (COG)	1.5 pF	±0.25pF	50	0.70	-55 ~+125	±30ppm
0402N1R6A500HI	NP0 (COG)	1.6 pF	±0.05pF	50	0.70	-55 ~+125	±30ppm
0402N1R8B500HI	NP0 (COG)	1.8 pF	±0.1pF	50	0.70	-55 ~+125	±30ppm
0402N1R8C500HI	NP0 (COG)	1.8 pF	±0.25pF	50	0.70	-55 ~+125	±30ppm
0402N220J500HI	NP0 (COG)	22 pF	±5%	50	0.70	-55 ~+125	±30ppm
0402N221J500HI	NP0 (COG)	220 pF	±5%	50	0.70	-55 ~+125	±30ppm
0402N2R0B500HI	NP0 (COG)	2 pF	±0.1pF	50	0.70	-55 ~+125	±30ppm
0402N2R2B500HI	NP0 (COG)	2.2 pF	±0.1pF	50	0.70	-55 ~+125	±30ppm
0402N2R2C500HI	NP0 (COG)	2.2 pF	±0.25pF	50	0.70	-55 ~+125	±30ppm
0402N2R4B500HI	NP0 (COG)	2.4 pF	±0.1pF	50	0.70	-55 ~+125	±30ppm
0402N2R4C500HI	NP0 (COG)	2.4 pF	±0.25pF	50	0.70	-55 ~+125	±30ppm
0402N2R7C500HI	NP0 (COG)	2.7 pF	±0.25pF	50	0.70	-55 ~+125	±30ppm
0402N330J500HI	NP0 (COG)	33 pF	±5%	50	0.70	-55 ~+125	±30ppm
0402N391F500HI	NP0 (COG)	390 pF	±1%	50	0.70	-55 ~+125	±30ppm

**ELECTRICAL CHARACTERISTICS – 50V NP0 (COG), X5R & X7R FOR DIFFERENT PART CODE**

NEXTGEN PART CODE	TEMP. COEFFICIENT	CAPACITANCE	TOLERANCE	VOLTAGE	THICKNESS (MAX.)	OPERATING TEMP. RANGE	CAPACITANCE CHARACTERISTIC
	-	-	-	V	mm	°C	-
0402N3R3C500HI	NP0 (COG)	3.3 pF	±0.25pF	50	0.70	-55 ~+125	±30ppm
0402N471J500HI	NP0 (COG)	470 pF	±5%	50	0.70	-55 ~+125	±30ppm
0402N4R0C500HI	NP0 (COG)	4 pF	±0.25pF	50	0.70	-55 ~+125	±30ppm
0402N4R7B500HI	NP0 (COG)	4.7 pF	±0.1pF	50	0.70	-55 ~+125	±30ppm
0402N4R7C500HI	NP0 (COG)	4.7 pF	±0.25pF	50	0.70	-55 ~+125	±30ppm
0402N5R6B500HI	NP0 (COG)	5.6 pF	±0.1pF	50	0.70	-55 ~+125	±30ppm
0402N5R6C500HI	NP0 (COG)	5.6 pF	±0.25pF	50	0.70	-55 ~+125	±30ppm
0402N6R0B500HI	NP0 (COG)	6 pF	±0.1pF	50	0.70	-55 ~+125	±30ppm
0402N6R0C500HI	NP0 (COG)	6 pF	±0.25pF	50	0.70	-55 ~+125	±30ppm
0402N6R2B500HI	NP0 (COG)	6.2 pF	±0.1pF	50	0.70	-55 ~+125	±30ppm
0402N6R8B500HI	NP0 (COG)	6.8 pF	±0.1pF	50	0.70	-55 ~+125	±30ppm
0402N6R8D500HI	NP0 (COG)	6.8 pF	±0.5pF	50	0.70	-55 ~+125	±30ppm
0402N8R0C500HI	NP0 (COG)	8.0 pF	±0.25pF	50	0.70	-55 ~+125	±30ppm
0402N8R2C500HI	NP0 (COG)	8.2 pF	±0.25pF	50	0.70	-55 ~+125	±30ppm
0402W104K500HI	X5R	0.1 μF	±10%	50	0.70	-55 ~+85	±15%
0603B101K500SD	X7R	100 pF	±10%	50	0.90	-55 ~+125	±15%
0603B102K500SD	X7R	1000 pF	±10%	50	0.90	-55 ~+125	±15%
0603B103K500SD	X7R	0.01 μF	±10%	50	0.90	-55 ~+125	±15%
0603B104J500XD	X7R	0.1 μF	±5%	50	1.00	-55 ~+125	±15%
0603B104K500XD	X7R	0.1 μF	±10%	50	1.00	-55 ~+125	±15%

**ELECTRICAL CHARACTERISTICS** – 50V NP0 (COG) & X7R FOR DIFFERENT PART CODE

NEXTGEN PART CODE	TEMP. COEFFICIENT	CAPACITANCE	TOLERANCE	VOLTAGE	THICKNESS (MAX.)	OPERATING TEMP. RANGE	CAPACITANCE CHARACTERISTIC
	-	-	-	V	mm	°C	-
0603B105K500XD	X7R	1 $\mu$ F	$\pm 10\%$	50	1.00	-55 ~+125	$\pm 15\%$
0603B152K500SD	X7R	1500 pF	$\pm 10\%$	50	0.90	-55 ~+125	$\pm 15\%$
0603B221K500SD	X7R	220 pF	$\pm 10\%$	50	0.90	-55 ~+125	$\pm 15\%$
0603B222K500SD	X7R	2200 pF	$\pm 10\%$	50	0.90	-55 ~+125	$\pm 15\%$
0603B223K500SD	X7R	0.022 $\mu$ F	$\pm 10\%$	50	0.90	-55 ~+125	$\pm 15\%$
0603B224K500XD	X7R	0.22 $\mu$ F	$\pm 10\%$	50	1.00	-55 ~+125	$\pm 15\%$
0603B333K500XD	X7R	0.033 $\mu$ F	$\pm 10\%$	50	1.00	-55 ~+125	$\pm 15\%$
0603B334K500XD	X7R	0.33 $\mu$ F	$\pm 10\%$	50	1.00	-55 ~+125	$\pm 15\%$
0603B471K500SD	X7R	470 pF	$\pm 10\%$	50	0.90	-55 ~+125	$\pm 15\%$
0603B472K500SD	X7R	4700 pF	$\pm 10\%$	50	0.90	-55 ~+125	$\pm 15\%$
0603B474K500XD	X7R	0.47 $\mu$ F	$\pm 10\%$	50	1.00	-55 ~+125	$\pm 15\%$
0603B681K500SD	X7R	680 pF	$\pm 10\%$	50	0.90	-55 ~+125	$\pm 15\%$
0603B682K500SD	X7R	6800 pF	$\pm 10\%$	50	0.90	-55 ~+125	$\pm 15\%$
0603N0R5B500SD	NP0 (COG)	0.5 pF	$\pm 0.1$ pF	50	0.90	-55 ~+125	$\pm 30$ ppm
0603N100D500SD	NP0 (COG)	10 pF	$\pm 0.5$ pF	50	0.90	-55 ~+125	$\pm 30$ ppm
0603N100F500SD	NP0 (COG)	10 pF	$\pm 1\%$	50	0.90	-55 ~+125	$\pm 30$ ppm
0603N100G500SD	NP0 (COG)	10 pF	$\pm 2\%$	50	0.90	-55 ~+125	$\pm 30$ ppm
0603N100J500SD	NP0 (COG)	10 pF	$\pm 5\%$	50	0.90	-55 ~+125	$\pm 30$ ppm
0603N101J500SD	NP0 (COG)	100 pF	$\pm 5\%$	50	0.90	-55 ~+125	$\pm 30$ ppm
0603N102J500SD	NP0 (COG)	1000 pF	$\pm 5\%$	50	0.90	-55 ~+125	$\pm 30$ ppm

**ELECTRICAL CHARACTERISTICS – 50V NP0 (COG) FOR DIFFERENT PART CODE**

NEXTGEN PART CODE	TEMP. COEFFICIENT	CAPACITANCE	TOLERANCE	VOLTAGE	THICKNESS (MAX.)	OPERATING TEMP. RANGE	CAPACITANCE CHARACTERISTIC
	-	-	-	V	mm	°C	-
0603N120F500SD	NP0 (COG)	12 pF	±1%	50	0.90	-55 ~+125	±30ppm
0603N120J500SD	NP0 (COG)	12 pF	±5%	50	0.90	-55 ~+125	±30ppm
0603N150J500SD	NP0 (COG)	15 pF	±5%	50	0.90	-55 ~+125	±30ppm
0603N180J500SD	NP0 (COG)	18 pF	±5%	50	0.90	-55 ~+125	±30ppm
0603N1R0B500SD	NP0 (COG)	1.0 pF	±0.1pF	50	0.90	-55 ~+125	±30ppm
0603N1R2B500SD	NP0 (COG)	1.2 pF	±0.1pF	50	0.90	-55 ~+125	±30ppm
0603N1R5B500SD	NP0 (COG)	1.5 pF	±0.1pF	50	0.90	-55 ~+125	±30ppm
0603N1R5C500SD	NP0 (COG)	1.5 pF	±0.25pF	50	0.90	-55 ~+125	±30ppm
0603N200J500SD	NP0 (COG)	20 pF	±5%	50	0.90	-55 ~+125	±30ppm
0603N220J500SD	NP0 (COG)	22 pF	±5%	50	0.90	-55 ~+125	±30ppm
0603N270J500SD	NP0 (COG)	27 pF	±5%	50	0.90	-55 ~+125	±30ppm
0603N2R0C500SD	NP0 (COG)	2 pF	±0.25pF	50	0.90	-55 ~+125	±30ppm
0603N2R2B500SD	NP0 (COG)	2.2 pF	±0.1pF	50	0.90	-55 ~+125	±30ppm
0603N2R4B500SD	NP0 (COG)	2.4 pF	±0.1pF	50	0.90	-55 ~+125	±30ppm
0603N2R5B500SD	NP0 (COG)	2.5 pF	±0.1pF	50	0.90	-55 ~+125	±30ppm
0603N2R7B500SD	NP0 (COG)	2.7 pF	±0.1pF	50	0.90	-55 ~+125	±30ppm
0603N300J500SD	NP0 (COG)	30 pF	±5%	50	0.90	-55 ~+125	±30ppm
0603N330J500SD	NP0 (COG)	33 pF	±5%	50	0.90	-55 ~+125	±30ppm
0603N331J500SD	NP0 (COG)	330 pF	±5%	50	0.90	-55 ~+125	±30ppm
0603N391J500SD	NP0 (COG)	390 pF	±5%	50	0.90	-55 ~+125	±30ppm



**ELECTRICAL CHARACTERISTICS – 50V NP0 (COG) FOR DIFFERENT PART CODE**

NEXTGEN PART CODE	TEMP. COEFFICIENT	CAPACITANCE	TOLERANCE	VOLTAGE	THICKNESS (MAX.)	OPERATING TEMP. RANGE	CAPACITANCE CHARACTERISTIC
	-	-	-	V	mm	°C	-
0603N3R0B500SD	NP0 (COG)	3 pF	±0.1pF	50	0.90	-55 ~+125	±30ppm
0603N3R3B500SD	NP0 (COG)	3.3 pF	±0.1pF	50	0.90	-55 ~+125	±30ppm
0603N3R3C500SD	NP0 (COG)	3.3 pF	±0.25pF	50	0.90	-55 ~+125	±30ppm
0603N3R3D500SD	NP0 (COG)	3.3 pF	±0.5pF	50	0.90	-55 ~+125	±30ppm
0603N3R9C500SD	NP0 (COG)	3.9 pF	±0.25pF	50	0.90	-55 ~+125	±30ppm
0603N3R9D500SD	NP0 (COG)	3.9 pF	±0.5pF	50	0.90	-55 ~+125	±30ppm
0603N470J500SD	NP0 (COG)	47 pF	±5%	50	0.90	-55 ~+125	±30ppm
0603N471J500SD	NP0 (COG)	470 pF	±5%	50	0.90	-55 ~+125	±30ppm
0603N4R0B500SD	NP0 (COG)	4 pF	±0.1pF	50	0.90	-55 ~+125	±30ppm
0603N560J500SD	NP0 (COG)	56 pF	±5%	50	0.90	-55 ~+125	±30ppm
0603N5R0C500SD	NP0 (COG)	5 pF	±0.25pF	50	0.90	-55 ~+125	±30ppm
0603N5R0D500SD	NP0 (COG)	5 pF	±0.5pF	50	0.90	-55 ~+125	±30ppm
0603N5R6C500SD	NP0 (COG)	5.6 pF	±0.25pF	50	0.90	-55 ~+125	±30ppm
0603N5R6D500SD	NP0 (COG)	5.6 pF	±0.5pF	50	0.90	-55 ~+125	±30ppm
0603N680J500SD	NP0 (COG)	68 pF	±5%	50	0.90	-55 ~+125	±30ppm
0603N6R0B500SD	NP0 (COG)	6 pF	±0.1pF	50	0.90	-55 ~+125	±30ppm
0603N6R8C500SD	NP0 (COG)	6.8 pF	±0.25pF	50	0.90	-55 ~+125	±30ppm
0603N6R8D500SD	NP0 (COG)	6.8 pF	±0.5pF	50	0.90	-55 ~+125	±30ppm
0603N7R0D500SD	NP0 (COG)	7 pF	±0.5pF	50	0.90	-55 ~+125	±30ppm
0603N820J500SD	NP0 (COG)	82 pF	±5%	50	0.90	-55 ~+125	±30ppm

**ELECTRICAL CHARACTERISTICS** – 50V NP0 (COG), X5R & X7R FOR DIFFERENT PART CODE

NEXTGEN PART CODE	TEMP. COEFFICIENT	CAPACITANCE	TOLERANCE	VOLTAGE	THICKNESS (MAX.)	OPERATING TEMP. RANGE	CAPACITANCE CHARACTERISTIC
	-	-	-	V	mm	°C	-
0603N8R0D500SD	NP0 (COG)	8 pF	±0.5pF	50	0.90	-55 ~+125	±30ppm
0603N8R2C500SD	NP0 (COG)	8.2 pF	±0.25pF	50	0.90	-55 ~+125	±30ppm
0603W105K500XD	X5R	1 µF	±10%	50	1.00	-55 ~+85	±15%
0603W225K500XD	X5R	22 µF	±10%	50	1.00	-55 ~+85	±15%
0805B101K500BD	X7R	100 pF	±10%	50	1.00	-55 ~+125	±15%
0805B102K500BD	X7R	1000 pF	±10%	50	1.00	-55 ~+125	±15%
0805B103K500BD	X7R	0.01 µF	±10%	50	1.00	-55 ~+125	±15%
0805B104J500BD	X7R	0.1 µF	±5%	50	1.00	-55 ~+125	±15%
0805B104K500BD	X7R	0.1 µF	±10%	50	1.00	-55 ~+125	±15%
0805B105K500CC	X7R	1.0 µF	±10%	50	1.45	-55 ~+125	±15%
0805B221K500BD	X7R	220 pF	±10%	50	1.00	-55 ~+125	±15%
0805B224K500CC	X7R	0.22 µF	±10%	50	1.45	-55 ~+125	±15%
0805B225K500CC	X7R	2.2 µF	±10%	50	1.45	-55 ~+125	±15%
0805B331K500BD	X7R	330 pF	±10%	50	1.00	-55 ~+125	±15%
0805B332K500BD	X7R	3300 pF	±10%	50	1.00	-55 ~+125	±15%
0805B333K500BD	X7R	0.033 µF	±10%	50	1.00	-55 ~+125	±15%
0805B334K500CC	X7R	0.33 µF	±10%	50	1.45	-55 ~+125	±15%
0805B471K500BD	X7R	470 pF	±10%	50	1.00	-55 ~+125	±15%
0805B472K500BD	X7R	4700 pF	±10%	50	1.00	-55 ~+125	±15%
0805B474K500CC	X7R	0.47 µF	±10%	50	1.45	-55 ~+125	±15%

**ELECTRICAL CHARACTERISTICS – 50V NP0 (COG) & X7R FOR DIFFERENT PART CODE**

NEXTGEN PART CODE	TEMP. COEFFICIENT	CAPACITANCE	TOLERANCE	VOLTAGE	THICKNESS (MAX.)	OPERATING TEMP. RANGE	CAPACITANCE CHARACTERISTIC
	-	-	-	V	mm	°C	-
0805B682K500BD	X7R	6800 pF	±10%	50	1.00	-55 ~+125	±15%
0805B684K500CC	X7R	0.68 μF	±10%	50	1.45	-55 ~+125	±15%
0805N101J500AD	NP0 (COG)	100 pF	±5%	50	0.70	-55 ~+125	±30ppm
0805N102J500BD	NP0 (COG)	1000 pF	±5%	50	1.00	-55 ~+125	±30ppm
0805N103J500AD	NP0 (COG)	0.01 μF	±5%	50	0.70	-55 ~+125	±30ppm
0805N121J500AD	NP0 (COG)	120 pF	±5%	50	0.70	-55 ~+125	±30ppm
0805N150J500AD	NP0 (COG)	15 pF	±5%	50	0.70	-55 ~+125	±30ppm
0805N180J500AD	NP0 (COG)	18 pF	±5%	50	0.70	-55 ~+125	±30ppm
0805N1R5C500AD	NP0 (COG)	1.5 pF	±0.25pF	50	0.70	-55 ~+125	±30ppm
0805N220J500AD	NP0 (COG)	22 pF	±5%	50	0.70	-55 ~+125	±30ppm
0805N221J500AD	NP0 (COG)	220 pF	±5%	50	0.70	-55 ~+125	±30ppm
0805N2R7C500AD	NP0 (COG)	2.7 pF	±0.25pF	50	0.70	-55 ~+125	±30ppm
0805N330J500AD	NP0 (COG)	33 pF	±5%	50	0.70	-55 ~+125	±30ppm
0805N331J500AD	NP0 (COG)	330 pF	±5%	50	0.70	-55 ~+125	±30ppm
0805N391J500AD	NP0 (COG)	390 pF	±5%	50	0.70	-55 ~+125	±30ppm
0805N3R3C500AD	NP0 (COG)	3.3 pF	±0.25pF	50	0.70	-55 ~+125	±30ppm
0805N470J500AD	NP0 (COG)	47 pF	±5%	50	0.70	-55 ~+125	±30ppm
0805N471J500BD	NP0 (COG)	470 pF	±5%	50	1.00	-55 ~+125	±30ppm
0805N4R7B500AD	NP0 (COG)	4.7 pF	±0.1pF	50	0.70	-55 ~+125	±30ppm
0805N560J500AD	NP0 (COG)	56 pF	±5%	50	0.70	-55 ~+125	±30ppm

**ELECTRICAL CHARACTERISTICS** – 50V NP0 (COG), X5R & X7R FOR DIFFERENT PART CODE

NEXTGEN PART CODE	TEMP. COEFFICIENT	CAPACITANCE	TOLERANCE	VOLTAGE	THICKNESS (MAX.)	OPERATING TEMP. RANGE	CAPACITANCE CHARACTERISTIC
	-	-	-	V	mm	°C	-
0805N5R0C500AD	NP0 (COG)	5 pF	±0.25pF	50	0.70	-55 ~+125	±30ppm
0805N681J500BD	NP0 (COG)	680 pF	±5%	50	1.00	-55 ~+125	±30ppm
0805N6R8C500AD	NP0 (COG)	6.8 pF	±0.25pF	50	0.70	-55 ~+125	±30ppm
0805W106K500CC	X5R	10 µF	±10%	50	1.45	-55 ~+85	±15%
0805W225K500CC	X5R	2.2 µF	±10%	50	1.45	-55 ~+85	±15%
0805W475K500CC	X5R	4.7 µF	±10%	50	1.45	-55 ~+85	±15%
0805W475M500CC	X5R	4.7 µF	±20%	50	1.45	-55 ~+85	±15%
1206B102K500BD	X7R	1000 pF	±10%	50	1.00	-55 ~+125	±15%
1206B104K500BD	X7R	0.1 µF	±10%	50	1.00	-55 ~+125	±15%
1206B105K500PB	X7R	1 µF	±10%	50	1.90	-55 ~+125	±15%
1206B331K500BD	X7R	330 pF	±10%	50	1.00	-55 ~+125	±15%
1206B475K500PB	X7R	4.7 µF	±10%	50	1.90	-55 ~+125	±15%
1206N1R5C500BD	NP0 (COG)	1.5 pF	±0.25pF	50	1.00	-55 ~+125	±30ppm
1206N7R5C500BD	NP0 (COG)	7.5 pF	±0.25pF	50	1.00	-55 ~+125	±30ppm
1206N8R2D500BD	NP0 (COG)	8.2 pF	±0.5pF	50	1.00	-55 ~+125	±30ppm
1210B105K500CC	X7R	1 µF	±10%	50	1.45	-55°C ~ 125	±15%
1210B106K500MA	X7R	10 µF	±10%	50	2.80	-55°C ~ 125	±15%
1210B106M500MA	X7R	10 µF	±20%	50	2.80	-55°C ~ 125	±15%
1210N472J500IC	NP0 (COG)	4700 pF	±5%	50	1.05	-55°C ~ 125	±30ppm
1210W106K500MA	X5R	10 µF	±10%	50	2.80	-55°C ~ +85	±15%



**ELECTRICAL CHARACTERISTICS** – 100V NPO (COG) & X7R FOR DIFFERENT PART CODE

NEXTGEN PART CODE	TEMP. COEFFICIENT	CAPACITANCE	TOLERANCE	VOLTAGE	THICKNESS (MAX.)	OPERATING TEMP. RANGE	CAPACITANCE CHARACTERISTIC
	-	-	-	V	mm	°C	-
0603B101K101SD	X7R	100 pF	±10%	100	0.90	-55 ~+125	±15%
0603B102K101SD	X7R	1000 pF	±10%	100	0.90	-55 ~+125	±15%
0603B103K101SD	X7R	0.01 μF	±10%	100	0.90	-55 ~+125	±15%
0603B104K101XD	X7R	0.1 μF	±10%	100	1.00	-55 ~+125	±15%
0603B332K101SD	X7R	3300 pF	±10%	100	0.90	-55 ~+125	±15%
0603B472K101SD	X7R	4700 pF	±10%	100	0.90	-55 ~+125	±15%
0603B681K101SD	X7R	680 pF	±10%	100	0.90	-55 ~+125	±15%
0603B682K101SD	X7R	6800 pF	±10%	100	0.90	-55 ~+125	±15%
0603N101J101SD	NPO (COG)	100 pF	±5%	100	0.90	-55 ~+125	±30ppm
0603N221G101SD	NPO (COG)	220 pF	±2%	100	0.90	-55 ~+125	±30ppm
0603N330J101SD	NPO (COG)	33 pF	±5%	100	0.90	-55 ~+125	±30ppm
0603N331J101SD	NPO (COG)	330 pF	±5%	100	0.90	-55 ~+125	±30ppm
0603N470J101SD	NPO (COG)	47 pF	±5%	100	0.90	-55 ~+125	±30ppm
0603N471J101SD	NPO (COG)	470 pF	±5%	100	0.90	-55 ~+125	±30ppm
0603N511J101SD	NPO (COG)	510 pF	±5%	100	0.90	-55 ~+125	±30ppm
0603N680F101SD	NPO (COG)	68 pF	±1%	100	0.90	-55 ~+125	±30ppm
0603N680J101SD	NPO (COG)	68 pF	±5%	100	0.90	-55 ~+125	±30ppm
0603N680K101SD	NPO (COG)	68 pF	±10%	100	0.90	-55 ~+125	±30ppm
0603N820J101SD	NPO (COG)	82 pF	±5%	100	0.90	-55 ~+125	±30ppm
0805B101K101BD	X7R	100 pF	±10%	100	1.00	-55 ~+125	±15%

**ELECTRICAL CHARACTERISTICS** – 100V NP0 (COG) & X7R FOR DIFFERENT PART CODE

NEXTGEN PART CODE	TEMP. COEFFICIENT	CAPACITANCE	TOLERANCE	VOLTAGE	THICKNESS (MAX.)	OPERATING TEMP. RANGE	CAPACITANCE CHARACTERISTIC
	-	-	-	V	mm	°C	-
0805B102K101BD	X7R	1000 pF	±10%	100	1.00	-55 ~+125	±15%
0805B104K101CC	X7R	0.1 μF	±10%	100	1.45	-55 ~+125	±15%
0805B152K101BD	X7R	1500 pF	±10%	100	1.00	-55 ~+125	±15%
0805B153K101BD	X7R	0.015 μF	±10%	100	1.00	-55 ~+125	±15%
0805B221K101BD	X7R	220 pF	±10%	100	1.00	-55 ~+125	±15%
0805B222K101BD	X7R	2200 pF	±10%	100	1.00	-55 ~+125	±15%
0805B223K101BD	X7R	0.022 μF	±10%	100	1.00	-55 ~+125	±15%
0805B224K101CC	X7R	0.22 μF	±10%	100	1.45	-55 ~+125	±15%
0805B272K101BD	X7R	2700 pF	±10%	100	1.00	-55 ~+125	±15%
0805B471K101BD	X7R	470 pF	±10%	100	1.00	-55 ~+125	±15%
0805B472K101BD	X7R	4700 pF	±10%	100	1.00	-55 ~+125	±15%
0805B473K101CC	X7R	0.047 μF	±10%	100	1.45	-55 ~+125	±15%
0805N100J101AD	NP0 (COG)	10 pF	±5%	100	0.70	-55 ~+125	±30ppm
0805N101J101AD	NP0 (COG)	100 pF	±5%	100	0.70	-55 ~+125	±30ppm
0805N221J101AD	NP0 (COG)	220 pF	±5%	100	0.70	-55 ~+125	±30ppm
0805N222K101XD	NP0 (COG)	2200 pF	±10%	100	1.00	-55 ~+125	±30ppm
0805N2R2C101AD	NP0 (COG)	2.2 pF	±0.25pF	100	0.70	-55 ~+125	±30ppm
0805N331J101AD	NP0 (COG)	330 pF	±5%	100	0.70	-55 ~+125	±30ppm
0805N332J101CC	NP0 (COG)	3300 pF	±5%	100	1.45	-55 ~+125	±30ppm
0805N470J101AD	NP0 (COG)	47 pF	±5%	100	0.70	-55 ~+125	±30ppm

**ELECTRICAL CHARACTERISTICS – 100V NP0 (COG) & X7R FOR DIFFERENT PART CODE**

NEXTGEN PART CODE	TEMP. COEFFICIENT	CAPACITANCE	TOLERANCE	VOLTAGE	THICKNESS (MAX.)	OPERATING TEMP. RANGE	CAPACITANCE CHARACTERISTIC
	-	-	-	V	mm	°C	-
0805N4R7C101AD	NP0 (COG)	4.7 pF	±0.25pF	100	0.70	-55 ~+125	±30ppm
0805N561J101AD	NP0 (COG)	560 pF	±5%	100	0.70	-55 ~+125	±30ppm
0805N681J101XD	NP0 (COG)	680 pF	±5%	100	1.00	-55 ~+125	±30ppm
0805N821J101XD	NP0 (COG)	820 pF	±5%	100	1.00	-55 ~+125	±30ppm
1206B102K101BD	X7R	1000 pF	±10%	100	1.00	-55 ~+125	±15%
1206B104K101CC	X7R	0.1 μF	±10%	100	1.45	-55 ~+125	±15%
1206B105K101PB	X7R	1 μF	±10%	100	1.90	-55 ~+125	±15%
1206B222K101BD	X7R	2200 pF	±10%	100	1.00	-55 ~+125	±15%
1206B224K101DC	X7R	0.22 μF	±10%	100	1.80	-55 ~+125	±15%
1206B225K101PB	X7R	2.2 μF	±10%	100	1.90	-55 ~+125	±15%
1206B334K101DC	X7R	0.33 μF	±10%	100	1.80	-55 ~+125	±15%
1206B471K101BD	X7R	470 pF	±10%	100	1.00	-55 ~+125	±15%
1206B472K101BD	X7R	4700 pF	±10%	100	1.00	-55 ~+125	±15%
1206N101J101BD	NP0 (COG)	100 pF	±5%	100	1.00	-55 ~+125	±30ppm
1206N102J101BD	NP0 (COG)	1000 pF	±5%	100	1.00	-55 ~+125	±30ppm
1206N152J101BD	NP0 (COG)	1500 pF	±5%	100	1.00	-55 ~+125	±30ppm
1206N471J101BD	NP0 (COG)	470 pF	±5%	100	1.00	-55 ~+125	±30ppm
1206N472J101BD	NP0 (COG)	4700 pF	±5%	100	1.00	-55 ~+125	±30ppm
1206N680J101BD	NP0 (COG)	68 pF	±5%	100	1.00	-55 ~+125	±30ppm
1210B105K101KA	X7R	1.0 μF	±10%	100	2.20	-55°C ~ 125	±15%



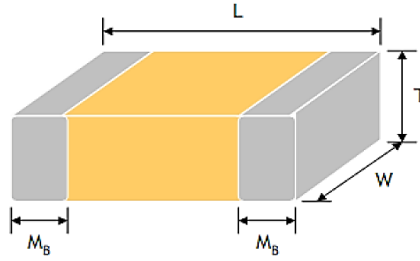

**DIMENSION** (Unit: mm)

SIZE CODE	METRIC CODE	L	W	T (SYMBOL )		SOLDERING METHOD	Mb
0201	0603	0.6 ±0.09	0.30 ±0.09	0.3±0.09	L	R	0.15 +0.1/-0.05
0402	1005	1.00 ±0.20	0.50 ±0.20	0.50±0.05	N	R	0.25 +0.05/-0.10
				0.50±0.10	E	R	
				0.50±0.20	H	R	
0603	1608	1.60 ±0.20	0.80 ±0.20	0.50±0.20	H	R/W	0.40 ±0.15
				0.80±0.10	S	R/W	
				0.85±0.15	B	R/W	
				0.80±0.20	X	R/W	
0805	2012	2.00 ±0.20	1.25 ±0.20	0.50±0.20	H	R	0.50 ±0.20
				0.60±0.10	A	R/W	
				0.80±0.20	X	R/W	
				0.85±0.15	B	R/W	
				1.25±0.20	C	R	
1206	3216	3.20 ±0.30	1.60 ±0.30	0.85±0.15	B	R/W	0.60±0.20 0.50±0.25
				0.95±0.10	I	R	
				1.25±0.20	C	R	
				1.15±0.20	J	R	
				1.60±0.20	D	R	
				1.60±0.30	Y	R	
				1.60+0.30/-0.10	P	R	

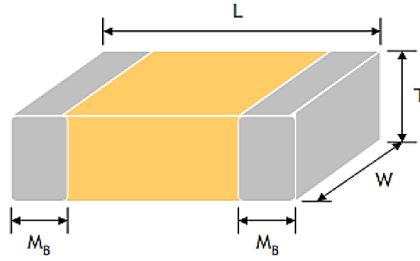
**DIMENSION** (Unit: mm)

SIZE CODE	METRIC CODE	L	W	T (SYMBOL )		SOLDERING METHOD	Mb
1210	3225	3.20 ±0.40	2.50 ±0.30	0.85±0.15	B	R	0.75±0.25
				0.95±0.10	I	R	
				1.25±0.20	C	R	
				1.60±0.20	D	R	
				1.60±0.30	Y	R	
				2.00±0.20	K	R	
				2.50±0.30	M	R	
1808	4520	4.50 ±0.40	2.03 ±0.25	1.25±0.20	C	R	0.75±0.25 0.50±0.25*
				1.40±0.20	F	R	
				1.60±0.20	D	R	
				2.00±0.20	K	R	
1812	4532	4.50 ±0.40	3.20 ±0.40	1.25±0.20	C	R	0.75±0.25 0.50±0.25*
				1.60±0.20	D	R	
				2.00±0.20	K	R	
				2.50±0.30	M	R	
				2.80±0.30	U	R	
1825	4563	4.50 ±0.40	6.30 ±0.40	1.60±0.20	D	R	0.75±0.35 0.85±0.35 0.85±0.35 0.85±0.35
				2.00±0.20	K	R	
				2.50±0.30	M	R	
				2.80±0.30	U	R	

**DIMENSION** (Unit: mm)

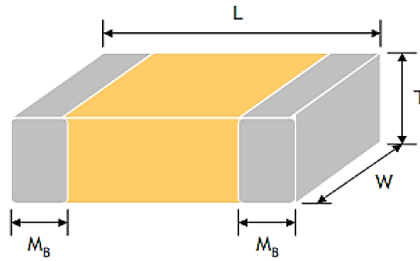

SIZE CODE	METRIC CODE	L	W	T (SYMBOL )		SOLDERING METHOD	Mb
2211	5728	5.70 ±0.40	2.80 ±0.30	1.60±0.20	D	R	0.75±0.35
				2.00±0.20	K		
				2.50±0.30	M		
				2.80±0.30	U		
2220	5750	5.70 ±0.40	5.00 ±0.40	1.60±0.20	D	R	0.75±0.35
				2.00±0.20	K		
				2.50±0.30	M		
				2.80±0.30	U		
2225	5763	5.70 ±0.40	6.30 ±0.40	1.60±0.20	D	R	0.75±0.35
				2.00±0.20	K		
				2.50±0.30	M		
				2.80±0.30	U		

**GENERAL ELECTRICAL CHARACTERISTICS**

DIELECTRIC	NPO (COG)	X7R	X5R	X6S
Size	0201, 0402, 0603, 0805, 1206, 1210, 1812, 1825, 2220, 2225			
Capacitance Range*	0.1pF to 0.1μF	100pF to 47μF	100pF to 220μF	0.1μF to 100μF
Capacitance Tolerance	Cap. ≤5pF (Note #1): A (±0.05pF), B (±0.1pF), C (±0.25pF) 5pF < Cap < 10pF: C (±0.25pF), D (±0.5pF) Cap ≥10pF: F (±1%), G (±2%), J (±5%), K (±10%)	J (±5%), K (±10%), M (±20%)	K (±10%), M (±20%)	K (±10%), M (±20%)
Rated Voltage	10V, 16V, 25V, 50V, 100V	6.3V, 10V, 16V, 25V, 50V, 100V		
Operating Temperature	-55 ~ +125°C		-55 ~ +85°C	-55 ~ +105°C
Capacitance Characteristic	±30ppm	±15%	±15%	±22%
Termination	Ni/Sn (lead-free termination)			

**Note:**

- #1: NPO, 0.1pF product only provide B tolerance; 0603N0R4 provide B&C tolerance; 0603N0R3 only provide C tolerance.
- \* Measured at the condition of 30~70% related humidity.
- NPO: Apply 1.0±0.2Vrms, 1.0MHz±10% for Cap ≤1000pF and 1.0±0.2Vrms, 1.0kHz±10% for Cap >1000pF, 25°C at ambient temperature.
- X7R/X6S/X5R/X6S: Please refer to “Reliability test conditions and requirements” for detail.
- \*\* Preconditioning for Class II MLCC: Perform a heat treatment at 150±10°C for 1 hour and then leave in ambient condition for 24±2 hours before measurement.

**X7R**

Table 1

RATED VOL.	D.F. $\leq$	EXCEPTION OF D.F. $\leq$	
$\geq 100V$	$\leq 2.5\%$	$\leq 3\%$	1206 $\geq 0.47\mu F$
		$\leq 5\%$	0603 $\geq 0.068\mu F$ ; 0805 $> 0.1\mu F$ ; 1206 $\geq 1\mu F$ ; 1210 $\geq 2.2\mu F$ ;
		$\leq 10\%$	0805 $> 0.22\mu F$ ; 1210 $\geq 3.3\mu F$
50V	$\leq 2.5\%$	$\leq 3\%$	0201(50V); 0603 $\geq 0.047\mu F$ ; 0805 $\geq 0.18\mu F$ ; 1206 $\geq 0.47\mu F$
		$\leq 5\%$	0201 $\geq 0.01\mu F$ ; 1210 $\geq 4.7\mu F$
		$\leq 10\%$	0402 $\geq 0.012\mu F$ ; 0603 $> 0.1\mu F$ ; 0805/X7R $> 0.47\mu F$ ; 1206 $\geq 2.2\mu F$ ; 1210 $\geq 10\mu F$ ;
35V	$\leq 3.5\%$	$\leq 10\%$	0603 $\geq 1\mu F$ ; 0805 $\geq 2.2\mu F$ ; 1206 $\geq 2.2\mu F$ ; 1210 $\geq 10\mu F$
25V	$\leq 3.5\%$	$\leq 5\%$	0201 $\geq 0.01\mu F$ ; 0805 $\geq 1\mu F$ ; 1210/X7R $\geq 10\mu F$
		$\leq 7\%$	0603 $\geq 0.33\mu F$
		$\leq 10\%$	0201 $\geq 0.1\mu F$ ; 0402/X7R $\geq 0.056\mu F$ ; 0603 $\geq 0.47\mu F$ ; 0805 $\geq 2.2\mu F$ ; 1206 $\geq 4.7\mu F$ ; 1210 $\geq 22\mu F$
		$\leq 12.5\%$	0402 $\geq 0.47\mu F$
16V	$\leq 3.5\%$	$\leq 5\%$	0201 $\geq 0.01\mu F$ ; 0402 $\geq 0.033\mu F$ ; 0603 $\geq 0.15\mu F$ ; 0805 $\geq 0.68\mu F$ ; 1206 $\geq 2.2\mu F$ ; 1210 $\geq 4.7\mu F$
		$\leq 10\%$	0201/X7R $\geq 0.022\mu F$ ; 0402 $\geq 0.22\mu F$ ; 0603 $> 0.47\mu F$ ; 0805 $\geq 2.2\mu F$ ; 1206 $\geq 4.7\mu F$ ; 1210 $\geq 22\mu F$ ;
10V	$\leq 5.0\%$	$\leq 10\%$	0201 $\geq 0.012\mu F$ ; 0402 $\geq 0.22\mu F$ ; 0603 $\geq 0.33\mu F$ ; 0805 $\geq 2.2\mu F$ ; 1206 $\geq 2.2\mu F$ ; 1210 $\geq 22\mu F$ : 01R5/X5R
		$\leq 15\%$	0201 $\geq 0.1\mu F$ ; 0402 $\geq 1\mu F$
6.3V	$\leq 10\%$	$\leq 15\%$	0201 $\geq 0.1\mu F$ ; 0402 $\geq 1\mu F$ ; 0603 $\geq 10\mu F$ ; 0805 $\geq 4.7\mu F$ ; 1206 $\geq 47\mu F$ ; 1210 $\geq 100\mu F$
		$\leq 20\%$	0402 $\geq 2.2\mu F$
4V	$\leq 15\%$	-	-

**X5R**

Table 2

RATED VOL.	D.F. $\leq$	EXCEPTION OF D.F. $\leq$	
$\geq 100V$	$\leq 2.5\%$	$\leq 3\%$	1206 $\geq 0.47\mu F$
		$\leq 5\%$	0603 $\geq 0.068\mu F$ ; 0805 $> 0.1\mu F$ ; 1206 $\geq 1\mu F$ ; 1210 $\geq 2.2\mu F$ ;
		$\leq 10\%$	0805 $> 0.22\mu F$ ; 1210 $\geq 3.3\mu F$
50V	$\leq 2.5\%$	$\leq 3\%$	0201(50V); 0603 $\geq 0.047\mu F$ ; 0805 $\geq 0.18\mu F$ ; 1206 $\geq 0.47\mu F$
		$\leq 5\%$	0201 $\geq 0.01\mu F$ ; 1210 $\geq 4.7\mu F$
		$\leq 10\%$	0402 $\geq 0.012\mu F$ ; 0603 $> 0.1\mu F$ ; 0805 $\geq 1\mu F$ ; 1206 $\geq 2.2\mu F$ ; 1210 $\geq 10\mu F$ ;
35V	$\leq 3.5\%$	$\leq 10\%$	0603 $\geq 1\mu F$ ; 0805 $\geq 2.2\mu F$ ; 1206 $\geq 2.2\mu F$ ; 1210 $\geq 10\mu F$
25V	$\leq 3.5\%$	$\leq 5\%$	0201 $\geq 0.01\mu F$ ; 0805 $\geq 1\mu F$ ; 1210/X7R $\geq 10\mu F$
		$\leq 7\%$	0603 $\geq 0.33\mu F$
		$\leq 10\%$	0201 $\geq 0.1\mu F$ ; 0402 $\geq 0.10\mu F$ ; 0603 $\geq 0.47\mu F$ ; 0805 $\geq 2.2\mu F$ ; 1206 $\geq 4.7\mu F$ ; 1210/X5R $\geq 10\mu F$ ;
		$\leq 12.5\%$	0402 $\geq 0.47\mu F$
16V	$\leq 3.5\%$	$\leq 5\%$	0201 $\geq 0.01\mu F$ ; 0402 $\geq 0.033\mu F$ ; 0603 $\geq 0.15\mu F$ ; 0805 $\geq 0.68\mu F$ ; 1206 $\geq 2.2\mu F$ ; 1210 $\geq 4.7\mu F$
		$\leq 10\%$	0201 $\geq 0.1\mu F$ ; 0402 $\geq 0.22\mu F$ ; 01R5/X5R 0603 $> 0.47\mu F$ ; 0805 $\geq 2.2\mu F$ ; 1206 $\geq 4.7\mu F$ ; 1210 $\geq 22\mu F$
10V	$\leq 5.0\%$	$\leq 10\%$	0201 $\geq 0.012\mu F$ ; 0402 $\geq 0.22\mu F$ ; 0603 $\geq 0.33\mu F$ ; 0805 $\geq 2.2\mu F$ ; 1206 $\geq 2.2\mu F$ ; 1210 $\geq 22\mu F$
		$\leq 15\%$	0201 $\geq 0.1\mu F$ ; 0402 $\geq 1\mu F$
6.3V	$\leq 10\%$	$\leq 15\%$	0201 $\geq 0.1\mu F$ ; 0402 $\geq 1\mu F$ ; 0603 $\geq 10\mu F$ ; 0805 $\geq 4.7\mu F$ ; 1206 $\geq 47\mu F$ 1210 $\geq 100\mu F$
		$\leq 20\%$	0402 $\geq 2.2\mu F$
4V	$\leq 15\%$	-	-

**X6S**

Table 3

RATED VOL.	D.F. $\leq$	EXCEPTION OF D.F. $\leq$	
$\geq 100V$	$\leq 2.5\%$	$\leq 3\%$	1206 $\geq 0.47\mu F$
		$\leq 5\%$	0603 $\geq 0.068\mu F$ ; 0805 $> 0.1\mu F$ ; 1206 $\geq 1\mu F$ ; 1210 $\geq 2.2\mu F$ ;
		$\leq 10\%$	0805 $> 0.22\mu F$ ; 1210 $\geq 3.3\mu F$
50V	$\leq 2.5\%$	$\leq 3\%$	0201(50V); 0603 $\geq 0.047\mu F$ ; 0805 $\geq 0.18\mu F$ ; 1206 $\geq 0.47\mu F$
		$\leq 5\%$	0201 $\geq 0.01\mu F$ ; 1210 $\geq 4.7\mu F$
		$\leq 10\%$	0402 $\geq 0.012\mu F$ ; 0603 $> 0.1\mu F$ ; 0805 $\geq 1\mu F$ ; 1206 $\geq 2.2\mu F$ ; 1210 $\geq 10\mu F$ ;
35V	$\leq 3.5\%$	$\leq 10\%$	0603 $\geq 1\mu F$ ; 0805 $\geq 2.2\mu F$ ; 1206 $\geq 2.2\mu F$ ; 1210 $\geq 10\mu F$
25V	$\leq 3.5\%$	$\leq 5\%$	0201 $\geq 0.01\mu F$ ; 0805 $\geq 1\mu F$ ; 1210/X7R $\geq 10\mu F$
		$\leq 7\%$	0603 $\geq 0.33\mu F$
		$\leq 10\%$	0201 $\geq 0.1\mu F$ ; 0402 $\geq 0.10\mu F$ ; 0603 $\geq 0.47\mu F$ ; 0805 $\geq 2.2\mu F$ ; 1206 $\geq 4.7\mu F$ ; 1210 $\geq 22\mu F$ ;
		$\leq 12.5\%$	0402 $\geq 0.47\mu F$
16V	$\leq 3.5\%$	$\leq 5\%$	0201 $\geq 0.01\mu F$ ; 0402 $\geq 0.033\mu F$ ; 0603 $\geq 0.15\mu F$ ; 0805 $\geq 0.68\mu F$ ; 1206 $\geq 2.2\mu F$ ; 1210 $\geq 4.7\mu F$
		$\leq 10\%$	0201 $\geq 0.1\mu F$ ; 0402 $\geq 0.22\mu F$ ; 0603 $> 0.47\mu F$ ; 0805 $\geq 2.2\mu F$ ; 1206 $\geq 4.7\mu F$ ; 1210 $\geq 22\mu F$
10V	$\leq 5.0\%$	$\leq 10\%$	0201 $\geq 0.012\mu F$ ; 0402 $\geq 0.22\mu F$ ; 0603 $\geq 0.33\mu F$ ; 0805 $\geq 2.2\mu F$ ; 1206 $\geq 2.2\mu F$ ; 1210 $\geq 22\mu F$
		$\leq 15\%$	0201 $\geq 0.1\mu F$ ; 0402 $\geq 1\mu F$
6.3V	$\leq 10\%$	$\leq 15\%$	0201 $\geq 0.1\mu F$ ; 0402/X6S $\geq 0.47\mu F$ ; 0603 $\geq 10\mu F$ ; 0805 $\geq 4.7\mu F$ ; 1206 $\geq 47\mu F$ 1210 $\geq 100\mu F$
		$\leq 20\%$	0402 $\geq 2.2\mu F$
4V	$\leq 15\%$	-	-



**CAPACITANCE RANGE** - NP0 (COG) DIELECTRIC SIZE 0201, 0402, 0603

Table 4-A

SIZE	0201			0402					0603				
VDC (V)	16	25	50	10	16	25	50	100	10	16	25	50	100
0.1pF (0R1)	L	L	L	H	H	H	H						
0.2pF (0R2)	L	L	L	H	H	H	H						
0.3pF (0R3)	L	L	L	H	H	H	H						
0.4pF (0R4)	L	L	L	H	H	H	H						
0.5pF (0R5)	L	L	L	H	H	H	H	H	S	S	S	S	S
0.6pF (0R6)	L	L	L	H	H	H	H	H	S	S	S	S	S
0.7pF (0R7)	L	L	L	H	H	H	H	H	S	S	S	S	S
0.8pF (0R8)	L	L	L	H	H	H	H	H	S	S	S	S	S
0.9pF (0R9)	L	L	L	H	H	H	H	H	S	S	S	S	S
1.0pF (1R0)	L	L	L	H	H	H	H	H	S	S	S	S	S
1.2pF (1R2)	L	L	L	H	H	H	H	H	S	S	S	S	S
1.5pF (1R5)	L	L	L	H	H	H	H	H	S	S	S	S/B	S
1.6pF (1R6)							H						
1.8pF (1R8)	L	L	L	H	H	H	H	H	S	S	S	S	S
2.0pF (2R0)	L	L	L	H	H	H	H	H	S	S	S	S	S
2.2pF (2R2)	L	L	L	H	H	H	H	H	S	S	S	S	S
2.7pF (2R7)	L	L	L	H	H	H	H	H	S	S	S	S	S
3.0pF (3R0)	L	L	L	H	H	H	H	H	S	S	S	S	S
3.3pF (3R3)	L	L	L	H	H	H	H	H	S	S	S	S	S
3.9pF (3R9)	L	L	L	H	H	H	H	H	S	S	S	S/B	S
4.0pF (4R0)	L	L	L	H	H	H	H	H	S	S	S	S	S
4.7pF (4R7)	L	L	L	H	H	H	H	H	S	S	S	S/B	S
5.0pF (5R0)	L	L	L	H	H	H	H	H	S	S	S	S	S
5.6pF (5R6)	L	L	L	H	H	H	H	H	S	S	S	S/B	S
6.0pF (6R0)	L	L	L	H	H	H	H	H	S	S	S	S	S
6.8pF (6R8)	L	L	L	H	H	H	H	H	S	S	S	S	S
7.0pF (7R0)	L	L	L	H	H	H	H	H	S	S	S	S/B	S
8.0pF (8R0)	L	L	L	H	H	H	H	H	S	S	S	S	S
8.2pF (8R2)	L	L	L	H	H	H	H	H	S	S	S	S/B	S
9.0pF (9R0)	L	L	L	H	H	H	H	H	S	S	S	S	S

**CAPACITANCE RANGE** - NPO (COG) DIELECTRIC SIZE 0201, 0402, 0603

Table 4-B

SIZE	0201			0402					0603				
VDC (V)	16	25	50	10	16	25	50	100	10	16	25	50	100
10pF (100)	L	L	L	H	H	H	H	H	S	S	S	S	S
12pF (120)	L	L	L	H	H	H	H	H	S	S	S	S	S
15pF (150)	L	L	L	H	H	H	H	H	S	S	S	S/B	S
18pF (180)	L	L	L	H	H	H	H	H	S	S	S	S/B	S
22pF (220)	L	L	L	H	H	H	H/N	H	S	S	S	S/B	S
27pF (270)	L	L	L	H	H	H	H	H	S	S	S	S	S
30pF (300)						H							
33pF (330)	L	L	L	H	H	H	H	H	S	S	S/B	S/B	S
39pF (390)	L	L	L	H	H	H	H	H	S	S	S	S	S
47pF (470)	L	L	L	H	H	H	H	H	S	S	S	S/B	S
56pF (560)	L	L	L	H	H	H	H	H	S	S	S	S	S
68pF (680)	L	L	L	H	H	H	H	H	S	S	S	S	S
82pF (820)	L	L	L	H	H	H	H	H	S	S	S	S	S
100pF (101)	L	L	L	H	H	H	H/N	H	S	S	S	S/B	S
120pF (121)	L	L	L	H	H	H	H	H	S	S	S	S/B	S
150pF (151)	L	L	L	H	H	H	H	H	S	S	S	S	S
180pF (181)				H	H	H	H	H	S	S	S	S	S
220pF (221)				H	H	H	H	H	S	S	S	S	S
270pF (271)	L			H	H	H	H		S	S	S	S/B	S
330pF (331)	L			H	H	H	H		S	S	S	S/B	S
390pF (391)	L			H	H	H	H		S	S	S	S	S
470pF (471)	L			H	H	H	H		S	S	S	S	S
560pF (561)	L			H	H	H	H		S	S	S	S	S
680pF (681)				H	H	H	H		S	S	S	S	S
820pF (821)		L		H	H	H	H		S	S	S	S	S
1,000pF (102)				H	H	H	H		S	S	S/B	S	S
1,200pF (122)									X	X	X	X	X
1,500pF (152)									X	X	X	X	X
1,800pF (182)									X	X	X	X	

**CAPACITANCE RANGE - NP0 (COG) DIELECTRIC SIZE 0603**

Table 4-C

SIZE	0603			
VDC (V)	10	16	25	50
2,200pF (222)	X	X	X	X/B
2,700pF (272)	X	X	X	X/B
3,300pF (332)	X	X	X	X
3,900pF (392)	X	X	X	X
4,700pF (472)	X	X	X	X
5,600pF (562)	X	X	X	X
6,800pF (682)	X	X	X	S/X
8,200pF (822)	X	X	X	X
0.010μF (103)	X	X	X	X

**CAPACITANCE RANGE - NP0 (COG) DIELECTRIC - SIZE 0805, 1206**

Table 4-D

SIZE	0805					1206				
	10	16	25	50	100	10	16	25	50	100
0.5pF (0R5)	A	A	A	A	A					
0.6pF (0R6)	A	A	A	A	A					
0.7pF (0R7)	A	A	A	A	A					
0.8pF (0R8)	A	A	A	A	A					
0.9pF (0R9)	A	A	A	A	A					
1.0pF (1R0)	A	A	A	A	A				B	
1.2pF (1R2)	A	A	A	A	A	B	B	B	B	B
1.5pF (1R5)	A	A	A	A	A	B	B	B	B	B
1.8pF (1R8)	A	A	A	A	A	B	B	B	B	B
2.0pF (2R0)	A	A	A	A	A					
2.2pF (2R2)	A	A	A	A	A	B	B	B	B	B
2.7pF (2R7)	A	A	A	A	A	B	B	B	B	B
3.0pF (3R0)	A	A	A	A	A					
3.3pF (3R3)	A	A	A	A	A	B	B	B	B	B
3.9pF (3R9)	A	A	A	A	A	B	B	B	B	B
4.0pF (4R0)	A	A	A	A	A					

**CAPACITANCE RANGE - NP0 (COG) DIELECTRIC SIZE 0805, 1206**

Table 4-E

SIZE	0805					1206				
VDC (V)	10	16	25	50	100	10	16	25	50	100
4.7pF (4R7)	A	A	A	A	A	B	B	B	B	B
5.0pF (5R0)	A	A	A	A	A					
5.6pF (5R6)	A	A	A	A	A	B	B	B	B	B
6.0pF (6R0)	A	A	A	A	A					
6.8pF (6R8)	A	A	A	A	A	B	B	B	B	B
7.0pF (7R0)	A	A	A	A	A	B	B	B	B	B
8.0pF (8R0)	A	A	A	A	A					
8.2pF (8R2)	A	A	A	A	A	B	B	B	B	B
9.0pF (9R0)	A	A	A	A	A					
10pF (100)	A	A	A	A	A	B	B	B	B	B
12pF (120)	A	A	A	A	A					
15pF (150)	A	A	A	A	A	B	B	B	B	B
18pF (180)	A	A	A	A	A	B	B	B	B	B
22pF (220)	A	A	A	A	A	B	B	B	B	B
27pF (270)	A	A	A	A	A	B	B	B	B	B
33pF (330)	A	A	A	A	A	B	B	B	B	B
39pF (390)	A	A	A	A	A	B	B	B	B	B
47pF (470)	A	A	A	A	A	B	B	B	B	B
56pF (560)	A	A	A	A	A	B	B	B	B	B
68pF (680)	A	A	A	A	A	B	B	B	B	B
82pF (820)	A	A	A	A	A	B	B	B	B	B
100pF (101)	A	A	A	A	A	B	B	B	B	B
120pF (121)	A	A	A	A	A	B	B	B	B	B
150pF (151)	A	A	A	A	A	B	B	B	B	B
180pF (181)	A	A	A	A	A	B	B	B	B	B
220pF (221)	A	A	A	A	A	B	B	B	B	B
270pF (271)	A	A	A	A	A	B	B	B	B	B
330pF (331)	A	A	A	A	A	B	B	B	B	B
390pF (391)	B	B	B	B	B	B	B	B	B	B
470pF (471)	B	B	B	B	B					

**CAPACITANCE RANGE - NPO (COG) DIELECTRIC SIZE 0805, 1206**

Table 4-F

SIZE	0805					1206				
VDC (V)	10	16	25	50	100	10	16	25	50	100
560pF (561)	B	B	B	B	B	B	B	B	B	B
680pF (681)	B	B	B	B	B	B	B	B	B	B
820pF (821)	B	B	B	B	B	B	B	B	B	B
1,000pF (102)	B	B	B	B	B	B	B	B	B	B
1,200pF (122)	B	B	B	B	B	B	B	B	B	B
1,500pF (152)	B	B	B	B	B	B	B	B	B	B
1,800pF (182)	B	B	B	B	B	B	B	B	B	B
2,200pF (222)	B	B	B	B	B	B	B	B	B	B
2,700pF (272)	C	C	C	C	C	B	B	B	B	B
3,300pF (332)	C	C	C	C	C	B	B	B	B	B
3,900pF (392)	C	C	C	C	C	B	B	B	B	B
4,700pF (472)	C	C	C	C	C	B	B	B	B	B
5,600pF (562)	C	C	C	C	C	B	B	B	B	B
6,800pF (682)	C	C	C	C	C	I	I	I	I	I
8,200pF (822)	C	C	C	C		C	C	C	C	C
0.010μF (103)	C	C	C	C		C	C	C	C	C
0.012μF (123)	B	B	B	B		P	P	P	P	P
0.015μF (153)						P	P	P	P	P
0.018μF (183)	C	C	C	C		P	P	P	P	P
0.022μF (223)	C	C	C	C		P	P	P	P	P
0.027μF (273)						P	P	P	P	
0.033μF (333)						P	P	P	P	
0.039μF (393)						P	P	P	P	
0.047μF (473)						J	J	J	J	
0.056μF (563)						J	J	J	J	
0.068μF (683)						D	D	D	D	
0.082μF (823)						D	D	D	D	
0.1μF (104)						D	D	D	D	

**CAPACITANCE RANGE - NP0 (COG) DIELECTRIC SIZE 1210, 1812**

Table 4-G

SIZE	1210					1812		
	10	16	25	50	100	16	50	100
VDC (V)								
10pF (100)	I	I	I	I	I	C	C	C
15pF (150)	I	I	I	I	I	C	C	C
18pF (180)	I	I	I	I	I	C	C	C
22pF (220)	I	I	I	I	I	C	C	C
27pF (270)	I	I	I	I	I	C	C	C
33pF (330)	I	I	I	I	I	C	C	C
39pF (390)	I	I	I	I	I	C	C	C
47pF (470)	I	I	I	I	I	C	C	C
56pF (560)	I	I	I	I	I	C	C	C
68pF (680)	I	I	I	I	I	C	C	C
82pF (820)	I	I	I	I	I	C	C	C
100pF (101)	I	I	I	I	I	C	C	C
120pF (121)	I	I	I	I	I	C	C	C
150pF (151)	I	I	I	I	I	C	C	C
180pF (181)	I	I	I	I	I	C	C	C
220pF (221)	I	I	I	I	I	C	C	C
270pF (271)	I	I	I	I	I	C	C	C
330pF (331)	I	I	I	I	I	C	C	C
390pF (391)	I	I	I	I	I	C	C	C
560pF (561)	I	I	I	I	I	C	C	C
680pF (681)	I	I	I	I	I	C	C	C
820pF (821)	I	I	I	I	I	C	C	C
1,000pF (102)	I	I	I	I	I	C	C	C
1,200pF (122)	I	I	I	I	I	C	C	C
1,500pF (152)	I	I	I	I	I	C	C	C
1,800pF (182)	I	I	I	I	I	C	C	C
2,200pF (222)	I	I	I	I	I	C	C	C
2,700pF (272)	I	I	I	I	I	C	C	C
3,300pF (332)	I	I	I	I	I	C	C	C
3,900pF (392)	I	I	I	I	I	C	C	C



**CAPACITANCE RANGE - NP0 (COG) DIELECTRIC SIZE 1825, 2220, 2225**

Table 4- I

SIZE	1825		2220		2225	
	50	100	50	100	50	100
VDC (V)	50	100	50	100	50	100
10pF (100)	K	K	K	K	K	K
12pF (120)	K	K	K	K	K	K
15pF (150)	K	K	K	K	K	K
18pF (180)	K	K	K	K	K	K
22pF (220)	K	K	K	K	K	K
27pF (270)	K	K	K	K	K	K
33pF (330)	K	K	K	K	K	K
39pF (390)	K	K	K	K	K	K
47pF (470)	K	K	K	K	K	K
56pF (560)	K	K	K	K	K	K
68pF (680)	K	K	K	K	K	K
82pF (820)	K	K	K	K	K	K
100pF (101)	K	K	K	K	K	K
120pF (121)	K	K	K	K	K	K
150pF (151)	K	K	K	K	K	K
180pF (181)	K	K	K	K	K	K
220pF (221)	K	K	K	K	K	K
270pF (271)	K	K	K	K	K	K
330pF (331)	K	K	K	K	K	K
390pF (391)	K	K	K	K	K	K
470pF (471)	K	K	K	K	K	K
560pF (561)	K	K	K	K	K	K
680pF (681)	K	K	K	K	K	K
820pF (821)	K	K	K	K	K	K
1,000pF (102)	K	K	K	K	K	K
1,200pF (122)	K	K	K	K	K	K
1,500pF (152)	K	K	K	K	K	K
1,800pF (182)	K	K	K	K	K	K
2,200pF (222)	K	K	K	K	K	K
2,700pF (272)	K	K	K	K	K	K





**CAPACITANCE RANGE** – X7R DIELECTRIC SIZE 0201, 0402

Table 5-A

SIZE	0201					0402					
VDC (V)	6.3	10	16	25	50	6.3	10	16	25	50	100
100pF (101)	L	L	L	L	L	H	H	H	H	H	H
120pF (121)	L	L	L	L	L	H	H	H	H	H	H
150pF (151)	L	L	L	L	L	H	H	H	H	H	H
180pF (181)	L	L	L	L	L	H	H	H	H	H	H
220pF (221)	L	L	L	L	L	H	H	H	H	H	H
270pF (271)	L	L	L	L	L	H	H	H	H	H	H
330pF (331)	L	L	L	L	L	H	H	H	H	H	H
390pF (391)	L	L	L	L	L	H	H	H	H	H	H
470pF (471)	L	L	L	L	L	H	H	H	H	H	H
560pF (561)	L	L	L	L	L	H	H	H	H	H	H
680pF (681)	L	L	L	L	L	H	H	H	H	H	H
820pF (821)	L	L	L	L	L	H	H	H	H	H	H
1,000pF (102)	L	L	L	L	L	H	H	H	H	H	H
1,200pF (122)	L	L	L	L	L	H	H	H	H	H	H
1,500pF (152)	L	L	L	L	L	H	H	H	H	H	H
1,800pF (182)	L	L	L	L	L	H	H	H	H	H	H
2,200pF (222)	L	L	L	L	L	H	H	H	H	H	H
2,700pF (272)	L	L	L	L	L	H	H	H	H	H	H
3,300pF (332)	L	L	L	L	L	H	H	H	H	H	H
3,900pF (392)	L	L	L	L	L	H	H	H	H	H	H
4,700pF (472)	L	L	L	L	L	H	H	H	H	H	H
5,600pF (562)	L	L	L	L	L	H	H	H	H	H	H
6,800pF (682)	L	L	L	L	L	H	H	H	H	H	H
8,200pF (822)	L	L	L	L	L	H	H	H	H	H	H
0.010μF (103)	L	L	L	L	L	H	H	H	H	H	H
0.012μF (123)						H	H	H	H	H	H
0.015μF (153)						H	H	H	H	H	H
0.018μF (183)						H	H	H	H	H	H
0.022μF (223)						H	H	H	H	H	H

**CAPACITANCE RANGE - NP0 (COG) DIELECTRIC SIZE 1210, 1812**

Table 5-B

SIZE	0402				
VDC (V)	6.3	10	16	25	50
0.027µF (273)	H	H	H	H	H
0.033µF (333)	H	H	H	H	H
0.039µF (393)	H	H	H	H	H
0.047µF (473)	H	H	H	H	H
0.056µF (563)	H	H	H	H	H
0.068µF (683)	H	H	H	H	H
0.082µF (823)	H	H	H	H	H
0.10µF (104)	H	H	H	H	H
0.15µF (154)	H	H	H		
0.22µF (224)	H	H	H	H	
0.47µF (474)	H	H			
1.0µF (105)	H	H			

**CAPACITANCE RANGE - X7R DIELECTRIC - SIZE 0603, 0805**

Table 5-C

SIZE	0603						0805					
	6.3	10	16	25	50	100	6.3	10	16	25	50	100
100pF (101)	S	S	S	S/B	S/B	S	B	B	B	B	B	B
120pF (121)	S	S	S	S	S	S	B	B	B	B	B	B
150pF (151)	S	S	S	S	S	S	B	B	B	B	B	B
180pF (181)	S	S	S	S	S	S/B	B	B	B	B	B	B
220pF (221)	S	S	S	S	S/B	S	B	B	B	B	B	B
270pF (271)	S	S	S	S	S	S	B	B	B	B	B	B
330pF (331)	S	S	S	S	S	S	B	B	B	B	B	B
390pF (391)	S	S	S	S	S	S	B	B	B	B	B	B
470pF (471)	S	S	S	S	S/B	S	B	B	B	B	B	B
560pF (561)	S	S	S	S	S	S	B	B	B	B	B	B
680pF (681)	S	S	S	S	S	S	B	B	B	B	B	B
820pF (821)	S	S	S	S	S	S	B	B	B	B	B	B
1,000pF (102)	S	S	S	S/B	S/B	S/B	B	B	B	B	B	B
1,200pF (122)	S	S	S	S	S	S	B	B	B	B	B	B
1,500pF (152)	S	S	S	S/B	S	S	B	B	B	B	B	B

**CAPACITANCE RANGE - X7R DIELECTRIC - SIZE 0603, 0805**

Table 5-D

SIZE	0603						0805						
	VDC (V)	6.3	10	16	25	50	100	6.3	10	16	25	50	100
1,800pF (182)	S	S	S	S	S	S	S	B	B	B	B	B	B
2,200pF (222)	S	S	S	S	S/B	S	S	B	B	B	B	B	B
2,700pF (272)	S	S	S	S	S/B	S	S	B	B	B	B	B	B
3,300pF (332)	S	S	S	S	S	S	S	B	B	B	B	B	B
3,900pF (392)	S	S	S	S	S	S	S	B	B	B	B	B	B
4,700pF (472)	S	S	S	S	S	S	S	B	B	B	B	B	B
5,600pF (562)	S	S	S	S	S	S	S	B	B	B	B	B	B
6,800pF (682)	S	S	S	S/B	S	S	S	B	B	B	B	B	B
8,200pF (822)	S	S	S	S	S	S	S	B	B	B	B	B	B
0.010μF (103)	S	S	S	S/B	S/B	S	S	B	B	B	B	B	B
0.012μF (123)	S	S	S	S	S	X	X	B	B	B	B	B	B
0.015μF (153)	S	S	S	S/B	S/B	X	X	B	B	B	B	B	B
0.018μF (183)	S	S	S	S	S	X	X	B	B	B	B	B	B
0.022μF (223)	S	S	S	S	S/B	X	X	B	B	B	B	B	B
0.027μF (273)	S	S	S	S	S/B	X	X	B	B	B	B	B	C
0.033μF (333)	S	S	S	S	X/B	X	X	B	B	B	B	B	C
0.039μF (393)	S	S	S	S	X	X	X	B	B	B	B	B	C
0.047μF (473)	S	S	S	S	X	X	X	B	B	B	B	B	C
0.056μF (563)	S	S	S	S	X	X	X	B	B	B	B	B	C
0.068μF (683)	S	S	S	S	X/B	X	X	B	B	B	B	B	C
0.082μF (823)	S	S	S	S	X	X	X	B	B	B	B	B	C
0.10μF (104)	S	S	S/B	S/B	X	X	X	B	B	B	B	B	C
0.12μF (124)	S	S	S	X				B	B	B	B	C	C
0.15μF (154)	S	S	S/B	X				C	C	C	C	C	C
0.18μF (184)	S	S	S	X				C	C	C	C	C	C
0.22μF (224)	S	S	S/B	X/B	X			C	C	C	C	C	C
0.27μF (274)	X	X	X	X				C	C	C	C	C	
0.33μF (334)	X	X	X	X				C	C	C	C	C	
0.39μF (394)	X	X	X	X				C	C	C	C	C	

**CAPACITANCE RANGE - X7R DIELECTRIC - SIZE 0603, 0805**

Table 5-E

SIZE	0603					0805						
	VDC (V)	6.3	10	16	25	50	6.3	10	16	25	50	100
0.47µF (474)	X	X	X/B	X/B	X		C	C	C	C	C	C
0.56µF (564)	X	X	X				C	C	C	C		
0.68µF (684)	X	X	X				C	C	C	C		
0.82µF (824)	X	X	X				C	C	C	C		
1.0µF (105)	X	X	X	X	X		C	C	C	C	C	
1.5µF (155)							C	C	C	C		
2.2µF (225)	X	X/B	X				C	C	C	C	C	
4.7µF (475)	X	X	X				C	C	C	C		
10µF (106)							C*	C*	C*			

**CAPACITANCE RANGE - X7R DIELECTRIC - SIZE 1206, 1210**

Table 5-F

SIZE	1206						1210					
	VDC (V)	6.3	10	16	25	50	100	10	16	25	50	100
150pF (151)	B	B	B	B	B	B	B					
180pF (181)	B	B	B	B	B	B	B					
220pF (221)	B	B	B	B	B	B	B					
270pF (271)	B	B	B	B	B	B	B					
330pF (331)	B	B	B	B	B	B	B					
390pF (391)	B	B	B	B	B	B	B					
470pF (471)	B	B	B	B	B	B	B					
560pF (561)	B	B	B	B	B	B	B					
680pF (681)	B	B	B	B	B	B	B					
820pF (821)	B	B	B	B	B	B	B					
1,000pF (102)	B	B	B	B	B	B	B	I	I	I	I	I
1,200pF (122)	B	B	B	B	B	B	B	I	I	I	I	I
1,500pF (152)	B	B	B	B	B	B	B	I	I	I	I	I
1,800pF (182)	B	B	B	B	B	B	B	I	I	I	I	I
2,200pF (222)	B	B	B	B	B	B	B	I	I	I	I	I
2,700pF (272)	B	B	B	B	B	B	B	I	I	I	I	I
3,300pF (332)	B	B	B	B	B	B	B	I	I	I	I	I

**CAPACITANCE RANGE - X7R DIELECTRIC - SIZE 1206, 1210**

Table 5-G

SIZE	1206						1210				
VDC (V)	6.3	10	16	25	50	100	10	16	25	50	100
3,900pF (392)	B	B	B	B	B	B	I	I	I	I	I
4,700pF (472)	B	B	B	B	B	B	I	I	I	I	I
5,600pF (562)	B	B	B	B	B	B	I	I	I	I	I
6,800pF (682)	B	B	B	B	B	B	I	I	I	I	I
8,200pF (822)	B	B	B	B	B	B	I	I	I	I	I
0.010μF (103)	B	B	B	B	B	B	I	I	I	I	I
0.012μF (123)	B	B	B	B	B	B	I	I	I	I	I
0.015μF (153)	B	B	B	B	B	B	I	I	I	I	I
0.018μF (183)	B	B	B	B	B	B	I	I	I	I	I
0.022μF (223)	B	B	B	B	B	B	I	I	I	I	I
0.027μF (273)	B	B	B	B	B	B	I	I	I	I	I
0.033μF (333)	B	B	B	B	B	B	I	I	I	I	I
0.039μF (393)	B	B	B	B	B	B	I	I	I	I	I
0.047μF (473)	B	B	B	B	B	B	I	I	I	I	I
0.056μF (563)	B	B	B	B	B	B	I	I	I	I	I
0.068μF (683)	B	B	B	B	B	B	I	I	I	I	I
0.082μF (823)	B	B	B	B	B	C	I	I	I	I	I
0.10μF (104)	B	B	B	B	B	C	I	I	I	I	I
0.12μF (124)	B	B	B	B	B	C	I	I	I	I	I
0.15μF (154)	I	I	I	I	I	D	I	I	I	I	C
0.18μF (184)	I	I	I	I	I	D	I	I	I	I	C
0.22μF (224)	I	I	I	I	I/B	D	I	I	I	I	C
0.27μF (274)	I	I	I	I	C	D	I	I	I	I	D
0.33μF (334)	I	I	I	I	C	D	I	I	I	C	D
0.39μF (394)	I	I	I	J	P	D	I	I	I	C	M
0.47μF (474)	J	J	J	J	P	D	I	I	I	C	M
0.56μF (564)	J	J	J	J	P	P	C	C	C	C	M
0.68μF (684)	J	J	J	J	P	P	C	C	C	C	K
0.82μF (824)	J	J	J	J	P	P	C	C	C	C	K

**CAPACITANCE RANGE - X7R DIELECTRIC - SIZE 1206, 1210**

Table 5-H

SIZE	1206						1210				
VDC (V)	6.3	10	16	25	50	100	10	16	25	50	100
1.0μF (105)	J	J	J	J	P	P	C	C	C	C	K
1.5μF (155)	J	J	J	P				D	D	M	M
2.2μF (225)	J	J	J	P	P	P		D	D	M	M
3.3μF (475)	P	P	P	P				D	D	M	
4.7μF (475)	P	P	P	P	P		K	K	K	M	M
10μF (106)	P	P	P	P			K	K	K	M	
22μF (226)	P*	P*	P*				M	M	M		
47μF (476)							M				
100μF (107)	P*	P*									

**CAPACITANCE RANGE - X7R DIELECTRIC - SIZE 1812**

Table 5-I

SIZE	1812				
VDC (V)	10	16	25	50	100
1,000pF (102)	C	C	C	C	C
1,200pF (122)	C	C	C	C	C
1,500pF (152)	C	C	C	C	C
1,800pF (182)	C	C	C	C	C
2,200pF (222)	C	C	C	C	C
2,700pF (272)	C	C	C	C	C
3,300pF (332)	C	C	C	C	C
3,900pF (392)	C	C	C	C	C
4,700pF (472)	C	C	C	C	C
5,600pF (562)	C	C	C	C	C
6,800pF (682)	C	C	C	C	C
8,200pF (822)	C	C	C	C	C
0.010μF (103)	C	C	C	C	C
0.012μF (123)	C	C	C	C	C
0.015μF (153)	C	C	C	C	C
0.018μF (183)	C	C	C	C	C

**CAPACITANCE RANGE - X7R DIELECTRIC - SIZE 1812**

Table 5-J

SIZE	1812				
VDC (V)	10	16	25	50	100
0.022μF (223)	C	C	C	C	C
0.027μF (273)	C	C	C	C	C
0.033μF (333)	C	C	C	C	C
0.039μF (393)	C	C	C	C	C
0.047μF (473)	C	C	C	C	C
0.056μF (563)	C	C	C	C	C
0.068μF (683)	C	C	C	C	C
0.082μF (823)	C	C	C	C	C
0.10μF (104)	C	C	C	C	C
0.12μF (124)	C	C	C	C	C
0.15μF (154)	C	C	C	C	C
0.18μF (184)	C	C	C	C	C
0.22μF (224)	C	C	C	C	C
0.27μF (274)	C	C	C	C	C
0.33μF (334)	C	C	C	C	C
0.39μF (394)	C	C	C	C	C
0.47μF (474)	C	C	C	C	K
0.56μF (564)	C	C	C	C	K
0.68μF (684)	C	C	C	K	K
0.82μF (824)	C	C	C	K	K
1.0μF (105)	C	C	C	K	K
1.5μF (155)				K	K
2.2μF (225)				M	M



**CAPACITANCE RANGE - X7R DIELECTRIC - SIZE 1825, 2220, 2225**

Table 5-K

SIZE	1825		2220			2225		
	50	100	25	50	100	25	50	100
1,000pF (102)	K	K	K	K	K	K	K	K
1,200pF (122)	K	K	K	K	K	K	K	K
1,500pF (152)	K	K	K	K	K	K	K	K
1,800pF (182)	K	K	K	K	K	K	K	K
2,200pF (222)	K	K	K	K	K	K	K	K
2,700pF (272)	K	K	K	K	K	K	K	K
3,300pF (332)	K	K	K	K	K	K	K	K
3,900pF (392)	K	K	K	K	K	K	K	K
4,700pF (472)	K	K	K	K	K	K	K	K
5,600pF (562)	K	K	K	K	K	K	K	K
6,800pF (682)	K	K	K	K	K	K	K	K
8,200pF (822)	K	K	K	K	K	K	K	K
0.010μF (103)	K	K	K	K	K	K	K	K
0.012μF (123)	K	K	K	K	K	K	K	K
0.015μF (153)	K	K	K	K	K	K	K	K
0.018μF (183)	K	K	K	K	K	K	K	K
0.022μF (223)	K	K	K	K	K	K	K	K
0.027μF (273)	K	K	K	K	K	K	K	K
0.033μF (333)	K	K	K	K	K	K	K	K
0.039μF (393)	K	K	K	K	K	K	K	K
0.047μF (473)	K	K	K	K	K	K	K	K
0.056μF (563)	K	K	K	K	K	K	K	K
0.068μF (683)	K	K	K	K	K	K	K	K
0.082μF (823)	K	K	K	K	K	K	K	K
0.10μF (104)	K	K	K	K	K	K	K	K
0.12μF (124)	K	K	K	K	K	K	K	K
0.15μF (154)	K	K	K	K	K	K	K	K
0.18μF (184)	K	K	K	K	K	K	K	K
0.22μF (224)	K	K	K	K	K	K	K	K



**CAPACITANCE RANGE - X5R DIELECTRIC - SIZE 0201**

Table 6-A

SIZE	0201			
VDC (V)	10	16	25	50
100pF (101)		L	L	L
120pF (121)		L	L	L
150pF (151)		L	L	L
180pF (181)		L	L	L
220pF (221)		L	L	L
270pF (271)		L	L	L
330pF (331)		L	L	L
390pF (391)		L	L	L
470pF (471)		L	L	L
560pF (561)		L	L	L
680pF (681)		L	L	L
820pF (821)		L	L	L
1,000pF (102)	L	L	L	L
1,200pF (122)	L	L	L	
1,500pF (152)	L	L	L	
2,200pF (222)	L	L	L	
2,700pF (272)	L	L	L	
3,300pF (332)	L	L	L	
4,700pF (472)	L	L	L	

**CAPACITANCE RANGE - X5R DIELECTRIC - SIZE 0201**

Table 6-B

SIZE	0201					0402				
VDC (V)	6.3	10	16	25	50	6.3	10	16	25	50
6,800µF (682)		L	L	L						
0.010µF (103)	L	L	L	L	L					
0.015µF (153)	L	L								H
0.022µF (223)	L	L								H
0.027µF (273)	L	L						H		H
0.033µF (333)	L	L						H		H
0.039µF (393)	L	L						H		H
0.047µF (473)	L	L				H	H	H		H
0.056µF (563)	L	L				H	H	H		H
0.068µF (683)	L	L				H	H	H		H
0.082µF (823)	L	L				H	H	H		H
0.10µF (104)	L	L	L			H	H	H	H	H/E
0.15µF (154)						H	H	H	H	
0.22µF (224)	L	L	L*	L		H	H	H	H	H
0.33µF (334)	L*	L*				H	H			
0.47µF (474)	L					H	H	H	H	H
0.68µF (684)						H	H			
1.0µF (105)	L*	L*	L*			H	H	H	H	H
2.2µF (225)	L*	L*				H	H	H	H	
4.7µF (475)						H	H	H*		
10µF (106)						H*	H*	H*		
22µF (226)						H*				

**CAPACITANCE RANGE - X5R DIELECTRIC - SIZE 0603**

Table 6-C

SIZE	0603				
VDC (V)	6.3	10	16	25	50
0.22µF (224)	X	X	X	X	
0.27µF (274)		X	X	X	
0.33µF (334)	X	X	X	X	
0.39µF (394)		X	X	X	
0.47µF (474)	X	X/B	X	X	X

**CAPACITANCE RANGE - X5R DIELECTRIC - SIZE 0603, 0805**

Table 6-D

SIZE	0603					0805					
	VDC (V)	6.3	10	16	25	50	6.3	10	16	25	50
0.68μF (684)	X	X	X	X							
0.82μF (824)	X	X	X	X							
1.0μF (105)	X	X	X	X/B	X/B		C	C	C	C	
1.5μF (155)	X						C	C	C	C	
2.2μF (225)	X/B	X	X	X	X		C	C	C	C	C
3.3μF (335)	X	X					C	C	C	C	
4.7μF (475)	X	X	X	X			C	C	C	C	C
10μF (106)	X/B	X	X	X*			C	C	C	C	C
22μF (226)	X*	X*					C	C*	C*	C*	
47μF (476)							C*	C*			
100μF (107)							C*				

**CAPACITANCE RANGE - X5R DIELECTRIC - SIZE 1206, 1210**

Table 6-E

SIZE	1206					1210							
	VDC (V)	6.3	10	16	25	50	4	6.3	10	16	25	35	50
1.5μF (155)		J	J						K	K			
2.2μF (225)		J	J	P	P				K	K			
3.3μF (335)		P	P	P									
4.7μF (475)	P	P	P	P	P				K	K	K		
6.8μF (685)	P	P											
10μF (106)	P	P	P	P/D	P			K	K	K	K	M	M
22μF (226)	P	P	P	P				M	M	M	M	M	
47μF (476)	P	P	P*	P/Y				M	M	M*	M		
100μF (107)	P*							M*	M*				
220μF (227)							M*	M*					

Note: 1) The letter in cell is expressed the symbol of product thickness. 2) The letter in cell with “ \* ” mark is for “M tolerance” ( 20% ) only

**CAPACITANCE RANGE - X6S DIELECTRIC - SIZE 0201, 0402, 0603**

Table 7-A

SIZE	0201		0402				0603				
VDC (V)	4	6.3	6.3	10	16	25	4	6.3	10	16	25
0.10μF (104)	L	L									
0.22μF (224)		L									
0.47μF (474)			H								
1.0μF (105)	L*		H	H	H	H					
2.2μF (225)			H	H	H						
4.7μF (475)								X		X	X
10μF (106)								X*	X*	X*	
22μF (226)							X*	X*			

**CAPACITANCE RANGE - X6S DIELECTRIC - SIZE 0805, 1206, 1210**

Table 7-B

SIZE	0805						1206				1210			
VDC (V)	4	6.3	10	16	25	50	6.3	10	16	25	6.3	10	16	25
0.10μF (104)														
0.22μF (224)														
0.47μF (474)														
1.0μF (105)														
2.2μF (225)														
4.7μF (475)					C	C								
10μF (106)	C	C	C	C	C					D				
22μF (226)		C*	C*	C*				P	P*					M
47μF (476)	C*						P				M	M	M	
100μF (107)											M*			

Note: 1) The letter in cell is expressed the symbol of product thickness. 2) The letter in cell with “ \* ” mark is for “M tolerance” ( 20% ) only

**RELIABILITY TEST CONDITIONS AND REQUIREMENTS**

ITEM	TEST CONDITION	REQUIREMENTS
Visual and Mechanical	-	* No remarkable defect. * Dimensions to conform to individual spec. sheet.
Capacitance	Class I: (NP0) $\leq 1000\text{pF}$ , $1.0 \pm 0.2\text{Vrms}$ , $1\text{MHz} \pm 10\%$ $> 1000\text{pF}$ , $1.0 \pm 0.2\text{Vrms}$ , $1\text{KHz} \pm 10\%$	* Shall not exceed the limits given in the detailed spec.
Q/D.F (Dissipation Factor)	Class II: (X7R, X6S, X5R) $C \leq 10\mu\text{F}$ , $1.0 \pm 0.2\text{Vrms}$ , $1\text{KHz} \pm 10\%$ ** $C > 10\mu\text{F}$ , $0.5 \pm 0.2\text{Vrms}$ , $120\text{Hz} \pm 20\%$ ** Test condition: $0.5 \pm 0.2\text{Vrms}$ , $1\text{KHz} \pm 10\%$ X7R: 0805=106(6.3V), 0603/475(6.3V) X5R: 0201 $\geq 224$ (6.3V,10V,16V)*, 0402 $\geq 475$ (6.3V,16V), 0402 $\geq 225$ (10V), 0603=106 (6.3V,10V)TT18X $\geq 475$ (10V) , TT15X series X6S: 0201/474(4V),0201 $\geq 104$ (6.3V,10V)*, 0402 $\geq 225$ (6.3V), 0402/475 (10V), 0603/106 (6.3V), * Excluding X5R/0201/105(6.3V); 225(10V), X6S/0201/104(10V) ( $1.0 \pm 0.2\text{Vrms}$ , $1\text{KHz} \pm 10\%$ ) * Before initial measurement (Class II only): To apply de-aging at $150^\circ\text{C}$ for 1hr for $24 \pm 2$ hrs at room temp.	NP0: Cap $\geq 30\text{pF}$ , Q $\geq 1000$ ; Cap $< 30\text{pF}$ , Q $\geq 400+20C$ X7R, See <Table 1> X5R, See <Table 2> X6S: See <Table 3>
Dielectric Strength	* To apply voltage ( $\leq 100\text{V}$ ) 250%. * Duration: 1 to 5 sec. * Charge and discharge current less than 50mA.	* No evidence of damage or flash over during test.
Insulation Resistance	* Preconditioning for Class II MLCC: Perform a heat treatment at $150 \pm 10^\circ\text{C}$ for 1 hour, then leave in ambient condition for $24 \pm 2$ hours before measurement. To apply rated voltage for max. 120 sec.	Class I: (NP0) $10\text{G}\Omega$ or $RxC \geq 500\Omega\text{-F}$ whichever is smaller. Class II (X7R, X5R, X6S) $10\text{G}\Omega$ or $RxC \geq 500\Omega\text{-F}$ whichever is smaller. See <Table 8>

**RELIABILITY TEST CONDITIONS AND REQUIREMENTS**

ITEM	TEST CONDITION	REQUIREMENTS
Temperature Coefficient	With no electrical load. @Oprating Temp. Range NP0/X7R: @ -55~125° C; X5R: -55~ 85° C ; X6S: -55~105° C ; * Before initial measurement (Class II only): To apply de-aging at 150° C for 1hr then set for 24±2 hrs at room temp. • Measurement voltage for Class II: See <Table 9>	NP0: Within ±30ppm/° C X7R: Within ±15% X5R: Within ±15% X6S: Within ±22%
Adhesive Strength of Termination	*Pressurizing force: 2N (0201) and 5N (≤0603) and 10N (>0603); * Test time: 10±1 sec.	* No remarkable damage or removal of the terminations.
Vibration Resistance	Vibration frequency: 10~55 Hz/min. * Total amplitude: 1.5mm * Test time: 6 hrs. (Two hrs each in three * mutually perpendicular directions.) * Before initial measurement (Class II only): To apply de-aging at 150° C for 1hr then set for 24±2 hrs at room temp. * Cap./DF(Q) Measurement to be made after de-aging a 150° C for 1hr then set for 24±2 hrs at room temp.	* No remarkable damage or removal of the terminations. * No remarkable damage. * Cap change and Q/D.F.: To meet initial spec.
Bending Test	* The middle part of substrate shall be pressurized by means of the pressurizing rod at a rate of about 1 mm per second until the deflection becomes 1 mm and then the pressure shall be maintained for 5±1 sec. *Before initial measurement (Class II only): To apply de-aging at 150° C for 1hr then set for 24±2 hrs at room temp. Measurement to be made after keeping at room temp. for 24±2 hrs.	* No remarkable damage. * Cap change: NP0: within ±5% or 0.5pF whichever is larger X7R, X5R, X6S: within ±12.5% (This capacitance change means the change of capacitance under specified flexure of substrate from the capacitance measured before the test.)



**RELIABILITY TEST CONDITIONS AND REQUIREMENTS**

ITEM	TEST CONDITION	REQUIREMENTS
Resistance to Soldering Heat	<ul style="list-style-type: none"> <li>* Solder temperature: 260±5° C</li> <li>* Dipping time: 10±1 sec</li> <li>* Preheating: 120 to 150° C for 1 minute before immerse the capacitor in a eutectic solder.</li> <li>* Before initial measurement (Class II only): To apply de-aging at 150° C for 1hr then set for 24±2 hrs at room temp.</li> <li>* Cap. / DF(Q) / I.R. Measurement to be made after de-aging at 150° C for 1hr then set for 24±2 hrs at room</li> </ul>	<ul style="list-style-type: none"> <li>* No remarkable damage.</li> <li>* Cap change: NP0: within ±2.5% or 0.25pF whichever is larger X7R, X5R, X6S: within ±7.5%</li> <li>* Q/D.F., I.R. and dielectric strength: To meet initial requirements.</li> <li>* 25% max. leaching on each edge.</li> </ul>
Temperature Cycle	<ul style="list-style-type: none"> <li>*Conduct the five cycles according to the temperatures and time.</li> <li>Time (min.): 30±3 @ Min. operating temp.+0/-3 ° C</li> <li>Time (min.): 2~3 @ Room temperture</li> <li>Time (min.): 30±3 @ Max. operating temp.+3/-0 ° C</li> <li>Time (min.): 2~3 @ Room temperture</li> <li>* Before initial measurement (Class II only): Perform 150+0/-10° C for 1 hr and then set for 24±2 hrs at room temp.</li> <li>* Cap. / DF(Q) / I.R. Measurement to be made after de-aging at 150° C for 1hr then set for 24±2 hrs at room.</li> </ul>	<ul style="list-style-type: none"> <li>* No remarkable damage.</li> <li>* Cap change: NP0: within ±2.5% or 0.25pF whichever is larger X7R, X5R, X6S: within ±7.5%</li> <li>* Q/D.F., I.R. and dielectric strength: To meet initial requirements.</li> </ul>
Solder ability	<ul style="list-style-type: none"> <li>* Solder temperature: 235±5° C</li> <li>* Dipping time: 2±0.5 sec.</li> </ul>	<p>95% min. coverage of all metalized area</p>

**RELIABILITY TEST CONDITIONS AND REQUIREMENTS**

ITEM	TEST CONDITION	REQUIREMENTS
Humidity (Damp Heat) Steady State	<ul style="list-style-type: none"> <li>* Test temp.: 40±2° C</li> <li>* Humidity: 90~95% RH</li> <li>* Test time: 500+24/-0hrs.</li> <li>• Before initial measurement (Class II only): Perform 150+0/-10° C for 1 hr and then set for 24±2 hrs at room temp.</li> <li>* Cap. / DF(Q) / I.R. Measurement to be made after de-aging at 150° C for 1hr then set for 24±2 hrs at room temp.</li> </ul>	<ul style="list-style-type: none"> <li>* No remarkable damage.</li> <li>* Cap change: NPO: within ±5% or 0.5pF whichever is larger</li> <li>X7R, X5R, X6S: ≥10V**, within ±12.5%; 6.3V within ±25%;</li> <li>** 10V: 0603≥4.7μF; 0402≥1μF; 0201 ≥0.1μF, within ±25%;</li> <li>* Q/D.F. value: NPO: More than 30pF Q≥350, 10pF≤C≤30pF, Q≥275+2.5C Less than 10pF Q≥200+10C X7R, X5R, X6S: See &lt;Table 10&gt;</li> <li>*I.R.: ≥10V, 1GΩ or 50 Ω-F whichever is smaller. Class II (X7R, X5R, X6S) See &lt;Table 13&gt;</li> </ul>

**RELIABILITY TEST CONDITIONS AND REQUIREMENTS**

ITEM	TEST CONDITION	REQUIREMENTS
Humidity (Damp Heat) Load	<ul style="list-style-type: none"> <li>*Test temp.: 40±2° C</li> <li>* Humidity: 90~95%RH</li> <li>* Test time: 500+24/-0 hrs.</li> <li>* To apply voltage: rated voltage.</li> <li>* Before initial measurement (Class II only): To apply de-aging at 150° C for 1hr then set for 24±2 hrs at room temp.</li> <li>* Cap. / DF(Q) / I.R. Measurement to be made after de-aging at 150° C for 1hr.then set for 24±2 hrs at room temp</li> </ul>	<ul style="list-style-type: none"> <li>* No remarkable damage.</li> <li>Cap change: NP0: ±7.5% or 0.75pF whichever is larger.</li> <li>X7R, X5R, X6S: ≥10V**, within ±12.5%; ≤ 6.3V within ±25%;</li> <li>**10V: 0603 4.7≥μF; 0402 ≥1μF;</li> <li>0201≥0.1 μF, within ±25%;</li> <li>value: NP0: C≥30pF, Q≥200; C&lt;30pF, Q≥100+10/3C</li> <li>X7R, X5R, X6S: See &lt;Table 11&gt;</li> <li>* I.R.: ≥10V, 500MΩ or 25 Ω-F whichever is smaller.</li> <li>Class II (X7R, X5R, X6S)</li> <li>See &lt;Table 13&gt;</li> </ul>

**RELIABILITY TEST CONDITIONS AND REQUIREMENTS**

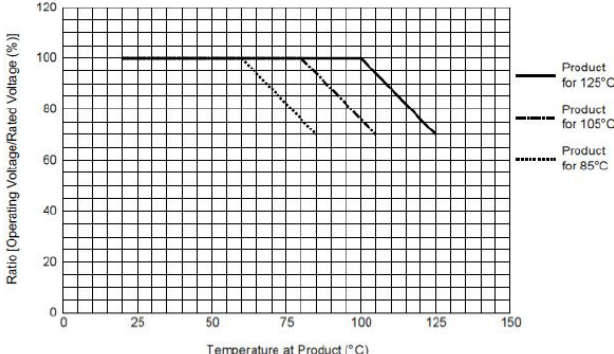
ITEM	TEST CONDITION	REQUIREMENTS
<p>High Temperature Load (Endurance)</p>	<p>* Test temp.: NP0, X7R: 125±3° C X6S: 105±3° C X5R: 85±3° C</p> <p>* Test time: 1000+24/-0 hrs.</p> <p>* To apply voltage:</p> <p>(1) <math>U \leq 6.3V</math> or <math>C \geq 10\mu F</math> : 150% of rated voltage.            (2) <math>10V \leq U &lt; 500V</math>: 200% of rated voltage.            (3) 500V: 150% of rated voltage.            (4) <math>U \geq 630V</math>: 120% of rated voltage.            (5) 100% of rated voltage for below range  <i>See Table 14</i></p> <p>(6) 150% of rated voltage for below range.  <i>See Table 15</i></p> <p>* Before initial measurement (Class II only): To apply de-aging at 150° C for 1hr then set for 24±2 hrs at room temp.</p> <p>* Cap. / DF(Q) / I.R. Measurement to be made after de-aging at 150° C for 1hr then set for 24±2 hrs at room temp.</p> <p>** De-rating conditions:</p> 	<p>* No remarkable damage. Cap change:</p> <p>NP0: <math>\pm 3.0\%</math> or <math>\pm 0.3pF</math> whichever is larger</p> <p>X7R, X5R, X6S: <math>\geq 10V^{**}</math>, within <math>\pm 12.5\%</math>; <math>\leq 6.3V</math> within <math>\pm 25\%</math>;</p> <p>** 10V: 0603<math>\geq 4.7\mu F</math>; 0402<math>\geq 1\mu F</math>;</p> <p>0201<math>\geq 0.1\mu F</math>, within <math>\pm 25\%</math>;</p> <p>Q/D.F. value:</p> <p>NP0: More than 30pF, <math>Q \geq 350</math></p> <p>10pF<math>\leq C &lt; 30pF</math>, <math>Q \geq 275 + 2.5C</math></p> <p>Less than 10pF,  <math>Q \geq 200 + 10C</math> X7R, X5R,  <i>X7R, X5R, X6S: See &lt;Table 12&gt;</i></p> <p>*I.R.: <math>\geq 10V</math>, 1GΩ or 50Ω-F whichever is smaller. Class II (X7R, X5R, X6S)  <i>See &lt;Table 13&gt;</i></p>

**INSULATION RESISTANCE** – Requirement - Class II (X7R, X5R, X6S)

Table 8

RATED VOLTAGE	IR
100V: All X7R	10GΩ or $RxC \geq 100 \Omega\text{-F}$ whichever is smaller
50V: 0402 > 0.01μF; 0603 $\geq 1\mu\text{F}$ ; 0805 $\geq 1\mu\text{F}$ ; 1206 $\geq 4.7\mu\text{F}$ ; 1210 $\geq 4.7\mu\text{F}$	
35V: 0805 $\geq 2.2\mu\text{F}$ ; 1206 $\geq 2.2\mu\text{F}$ ; 1210 $\geq 10\mu\text{F}$	
25V: 0402 $\geq 1\mu\text{F}$ ; 0603 $\geq 2.2\mu\text{F}$ ; 0805 $\geq 2.2\mu\text{F}$ ; 1206 $\geq 10\mu\text{F}$ ; 1210 $\geq 10\mu\text{F}$	
16V: 0201 $\geq 0.1\mu\text{F}$ ; 0402 $\geq 0.22\mu\text{F}$ ; 0603 $\geq 1\mu\text{F}$ ; 0805 $\geq 2.2\mu\text{F}$ ; 1206 $\geq 10\mu\text{F}$ ; 1210 $\geq 47\mu\text{F}$	
10V: 0201 $\geq 47\text{nF}$ ; 0402 $\geq 0.47\mu\text{F}$ ; 0603 $\geq 0.47\mu\text{F}$ ; 0805 $\geq 2.2\mu\text{F}$ ; 1206 $\geq 4.7\mu\text{F}$ ; 1210 $\geq 47\mu\text{F}$	
6.3V; 4V; Size $\geq 1812$	
All X6S items	$RxC \geq 50 \Omega\text{-F}$ .
100V: 1210 $\geq 3.3\mu\text{F}$	
50V: 0402 $\geq 0.1\mu\text{F}$ ; 0603 $\geq 2.2\mu\text{F}$ ; 0805 $\geq 10\mu\text{F}$ ; 1206 $\geq 10\mu\text{F}$	
35V: 0603 $\geq 1\mu\text{F}$	
25V: 0201 $\geq 0.1\mu\text{F}$ ; 0402 $\geq 0.22\mu\text{F}$ ; 0603 $\geq 10\mu\text{F}$ ; 0805 $\geq 10\mu\text{F}$ ; 1206 $\geq 22\mu\text{F}$	
16V: 0201 $\geq 0.22\mu\text{F}$ ; 0402 $\geq 1\mu\text{F}$ ; 0603 $\geq 10\mu\text{F}$	
10V: 0201 > 0.1μF; 0402 $\geq 1\mu\text{F}$ ; 0603 $\geq 10\mu\text{F}$ ; 0805 $\geq 47\mu\text{F}$	
6.3V: 0201 $\geq 0.1\mu\text{F}$ ; 0603 $\geq 4.7\mu\text{F}$ ; 0805 $\geq 47\mu\text{F}$ ; 1206 $\geq 10\mu\text{F}$	
4V: 0603 $\geq 22\mu\text{F}$ ; 0805 $\geq 47\mu\text{F}$ ; 1206 $\geq 100\mu\text{F}$	

**TEMPERATURE COEFFICIENT**- Test Condition Measurement voltage for Class II:

Table 9

MEASUREMENT VOLTAGE	SIZE
Cap $\leq 0.01\mu\text{F}$ : 0.5V; Cap. > 0.01μF: 0.2V	01005
Cap < 0.1μF: 1.0V; 0.1μF* $\leq$ Cap. < 1.0μF: 0.2V; Cap. $\geq 1.0\mu\text{F}$ : 0.1V (*: 0201x104/16V: 0.5V)	0201
Cap < 1μF: 1.0V; Cap. = 1μF: 0.5V; 1μF < Cap. < 10μF: 0.2V; Cap. $\geq 10\mu\text{F}$ : 0.1V	0402
Cap < 1.0μF: 1.0V; 1.0μF* $\leq$ Cap. $\leq 4.7\mu\text{F}$ : 0.5V; Cap. > 4.7μF: 0.2V	0603
Cap < 10μF: 1.0V; Cap. = 10μF: 0.5V; Cap. > 10μF: 0.2V	0805
Cap $\leq 10\mu\text{F}$ : 1.0V; 10μF < Cap. $\leq 100\mu\text{F}$ : 0.5V; Cap. > 100μF: 0.2V	1206/1210

**HUMIDITY (DAMP HEAT) STEADY STATE** -Requirement - (X7R, X5R, X6S)

Table 10

RATED VOL.	D.F. ≤	EXCEPTION OF D.F. ≤	
≥100V	≤ 3%	≤ 6%	1206 ≥ 0.47μF
		≤ 7.5%	0603 ≥ 0.068μF; 0805 > 0.1μF; 1206 ≥ 1μF; 1210 ≥ 2.2μF;
		≤ 20%	0805 > 0.22μF; 1210 ≥ 3.3μF
50V	≤ 3%	≤6%	0201(50V); 0603≥0.047μF; 0805≥0.18μF; 1206≥0.47μF
		≤10%	0201≥0.01uF; 1210≥4.7μF
		≤20%	0402≥0.012μF; 0603>0.1μF; 0805≥1μF(0805/X7R>0.47μF); 1206≥2.2μF; 1210≥10μF;
35V	≤ 5%	≤20%	0603≥1μF; 0805≥2.2μF; 1206≥2.2μF; 1210≥10μF
25V	≤ 5%	≤10%	0201≥0.01μF; 0805≥1μF; 1210≥10μF
		≤14%	0603≥0.33μF
		≤15%	0201≥0.1μF; 0402≥0.10μF&(0402/X7R≥0.056μF);0603≥0.47μF; 0805≥2.2μF; 1206≥4.7μF;1210≥22μF(1210/X5R≥10μF)
		≤20%	0402≥0.47μF
16V	≤5%	≤10%	0603≥0.15μF; 0805≥0.68μF; 1206≥2.2μF; 1210≥4.7μF
		≤15%	0201≥0.01μF(0201/X7R≥0.022μF);0402≥0.033μF; 0603>0.47μF;0805≥2.2μF;1206≥4.7μF; 1210≥22μF
10V	≤ 7.5%	≤15%	0201≥0.012μF;0402≥0.22μF; 0603≥0.33μF; 0805≥2.2μF; 1206≥2.2μF;1210≥22μF
		≤20%	0201≥0.1μF; 0402≥1μF
6.3V	≤ 15%	≤30%	0201≥0.1μF; 0402≥1μF(0402/X6S≥0.47μF); 0603≥10μF; 0805≥4.7μF; 1206≥47μF; 1210 ≥100μF
4V	≤20%	-	-

**HUMIDITY (DAMP HEAT) LOAD -REQUIREMENT - (X7R, X5R, X6S)**

Table 11

RATED VOL.	D.F. ≤	EXCEPTION OF D.F. ≤	
≥100V	≤ 3%	≤ 6%	1206 ≥ 0.47μF
		≤ 7.5%	0603 ≥ 0.068μF; 0805 > 0.1μF; 1206 ≥ 1μF; 1210 ≥ 2.2μF;
50V	≤ 3%	≤6%	0201(50V); 0603≥0.047μF; 0805≥0.18μF; 1206≥0.47μF
		≤10%	1210≥4.7μF
		≤20%	0402≥0.01μF; 0603>0.1μF; 0805≥1μF; 1206≥2.2μF; 1210≥10μF;
35V	≤ 5%	≤20%	0603≥1μF; 0805≥2.2μF; 1210≥10μF
25V	≤ 5%	≤10%	0201≥0.01μF; 0805≥1μF; 1210≥10μF
		≤14%	0603≥0.33μF; 1206≥4.7μF
		≤15%	0402≥0.10μF;0603≥0.47μF;0805≥2.2μF;1206≥6.8μF ; 1210≥22μF
		≤20%	0402≥1μF
16V	≤5%	≤10%	0201≥0.01μF;0402≥0.033μF;0603≥0.15μF; 0805≥0.68μF; 1206≥2.2μF; 1210≥4.7μF
		≤15%	0201≥0.01μF; 0402≥0.22μF; 0603>0.68μF;0805≥2.2μF;1206≥4.7μF; 1210≥22μF
10V	≤ 7.5%	≤15%	0201≥0.012μF;0402≥0.33μF(0402/X7R≥0.22μF) ;0603≥0.33μF;0805≥2.2μF;1206≥2.2μF;1210≥22μF
		≤20%	0201≥0.1μF; 0402≥1μF
6.3V	≤ 15%	≤30%	0201≥0.1μF; 0402≥1μF; 0603≥10μF; 0805≥4.7μF; 1206≥47μF; 1210 ≥100μF
4V	≤20%	-	-

**HIGH TEMPERATURE LOAD (ENDURANCE) -REQUIREMENT - (X7R, X5R, X6S)**

Table 12

RATED VOL.	D.F. ≤	EXCEPTION OF D.F. ≤	
≥100V	≤ 3%	≤ 6%	1206 ≥ 0.47μF
		≤ 7.5%	0603 ≥ 0.068μF; 0805 > 0.1μF; 1206 >1 μF;
50V	≤ 3%	≤6%	0201(50V); 0603≥0.047μF; 0805≥0.18μF; 1206≥0.47μF
		≤10%	1210≥4.7μF
		≤20%	0402≥0.1μF;0603>0.1μF;0805≥1μF; 1206≥2.2μF; 1210≥10μF
35V	≤ 5%	≤20%	0603≥1μF; 0805≥2.2μF; 1210≥10μF
25V	≤ 5%	≤10%	0201≥0.01μF; 0805≥1μF; 1210≥10μF
		≤14%	0603≥0.33μF; 1206≥4.7μF
		≤15%	0402≥0.10μF;0603≥0.47μF;0805≥2.2μF;1206≥6.8μF ; 1210≥22μF
		≤20%	0402≥1μF
16V	≤5%	≤10%	0201≥0.01μF;0402≥0.033μF;0603≥0.15μF; 0805≥0.68μF; 1206≥2.2μF; 1210≥4.7μF
		≤15%	0201≥0.01μF; 0402≥0.22μF; 0603>0.68μF;0805≥2.2μF;1206≥4.7μF; 1210≥22μF
10V	≤ 7.5%	≤15%	0201≥0.012μF;0402≥0.33μF(0402/X7R≥0.22μF) ;0603≥0.33μF;0805≥2.2μF;1206≥2.2μF;1210≥22μF
		≤20%	0201≥0.1μF; 0402≥1μF
6.3V	≤ 15%	≤30%	0201≥0.1μF; 0402≥1μF; 0603≥10μF; 0805≥4.7μF; 1206≥47μF; 1210 ≥100μF
4V	≤20%	-	-



**REQUIREMENT** - CLASS II (X7R, X5R, X6S)

Table 13

MEASUREMENT VOLTAGE	IR
100V: X7R; 1210 $\geq$ 3.3 $\mu$ F	1G $\Omega$ or RxC $\geq$ 10 $\Omega$ -F whichever is smaller
50V: 0402 $>$ 0.01 $\mu$ F; 0603 $\geq$ 1 $\mu$ F; 0805 $\geq$ 1 $\mu$ F; 1206 $\geq$ 4.7 $\mu$ F; 1210 $\geq$ 4.7 $\mu$ F	
35V: 0603 $\geq$ 1 $\mu$ F; 0805 $\geq$ 2.2 $\mu$ F; 1210 $\geq$ 10 $\mu$ F	
25V: 0201 $\geq$ 0.1 $\mu$ F; 0402 $\geq$ 0.22 $\mu$ F; 0603 $\geq$ 2.2 $\mu$ F; 0805 $\geq$ 2.2 $\mu$ F; 1206 $\geq$ 10 $\mu$ F; 1210 $\geq$ 10 $\mu$ F	
16V: 0201 $\geq$ 0.1 $\mu$ F; 0402 $\geq$ 0.22 $\mu$ F; 0603 $\geq$ 1 $\mu$ F ;0805 $\geq$ 2.2 $\mu$ F; 1206 $\geq$ 10 $\mu$ F; 1210 $\geq$ 47 $\mu$ F	
10V: 0201 $\geq$ 47nF; 0402 $\geq$ 0.47 $\mu$ F; 0603 $\geq$ 0.47 $\mu$ F; 0805 $\geq$ 2.2 $\mu$ F; 1206 $\geq$ 4.7 $\mu$ F; 1210 $\geq$ 47 $\mu$ F	
6.3V; 4V; All X6S items; Size $\geq$ 1812	

**HIGH TEMPERATURE LOAD (ENDURANCE) – Test Condition-100% of Rated Voltage**

Table 14

SIZE	DIELECTRIC	RATED VOLTAGE	CAPACITANCE
0201	X5R/X7R/X6S	≤10V	C≥0.1μF
		≥16V	C>0.1μF
0402	X5R	≤16V	C>1.0μF
		25V,50V	C≥1.0μF
	X6S	6.3V,10V	C>1.0μF
		16V,25V	C≥1.0μF
X7R	6.3V,10V	C≥1.0μF	
0603	X5R/X7R/X6S	4V	C≥22μF
		6.3V,10V	C≥4.7μF
	X5R/X6S	25V	C≥1.0μF
	X7R	35V	C≥1.0μF
0805	X5R/X7R/X6S	4V	C≥47μF
		6.3V	C≥22μF
		10V, 50V	C≥10μF
	X6S/X7R	16V, 25V	C≥10μF
	X5R		C≥22μF
1206	X5R/X7R/X6S	≤6.3V	C≥47μF
1210	X5R/X7R/X6S	16V	C≥47μF
	X7R	100V	C≥3.3μF

**HIGH TEMPERATURE LOAD (ENDURANCE) – Test Condition-150% of Rated Voltage**

Table 15

DIELECTRIC	RATED VOLTAGE	CAPACITANCE	DIELECTRIC
0201	X5R/X6S	16V, 25V	C= 0.1μF
	X7R	16V	C≥0.022μF
0402	X5R/X7R/X6S	50V	C>0.01μF
		10-25V	C≥0.22μF
0603	Y7R	50V	C>0.1μF
		25V	C=1.0μF
	X5R	50V	C≥1.0μF
	X5R/X7R/X6S	10V, 16V	C≥1.0μF
0805	X5R/X7R/X6S	100V	C≥0.47μF
		50V	C≥1.0μF
		35V	C≥2.2μF
		10-25V	C≥4.7μF
1206	X7R	100V	C≥1.0μF
		50V	C=4.7μF
	X5R/X6S	100V	C>1.0μF
		50V	C=4.7μF
1210	X5R/X7R/X6S	50-100V	C≥2.2μF
1825 2220 2225	X7R	100V-250V	C≥1.0μF

### RECOMMENDED PROFILE CONDITIONS

The lead-free termination MLCCs are not only to be used on SMT against lead-free solder paste, but also suitable against lead-containing solder paste.

If the optimized solder joint is requested, increasing soldering time, temperature and concentration of N<sub>2</sub> within oven are recommended.

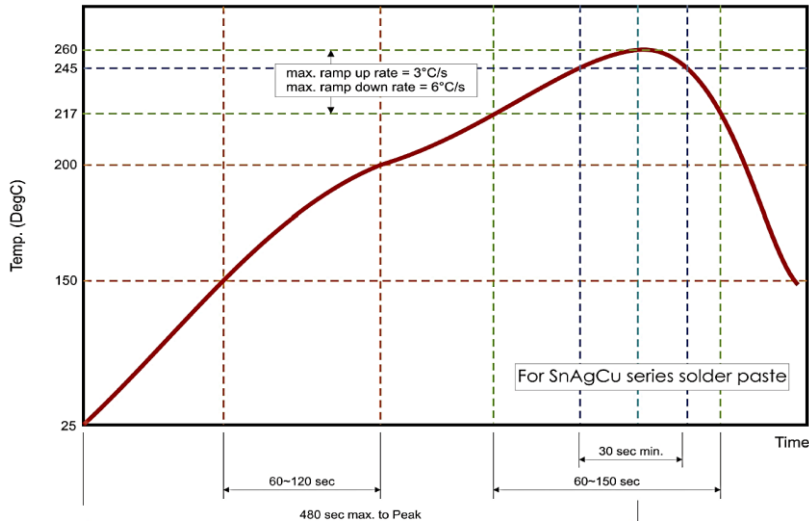

Reflow Soldering Profile For SMT Process with SnAgCu series Solder Paste

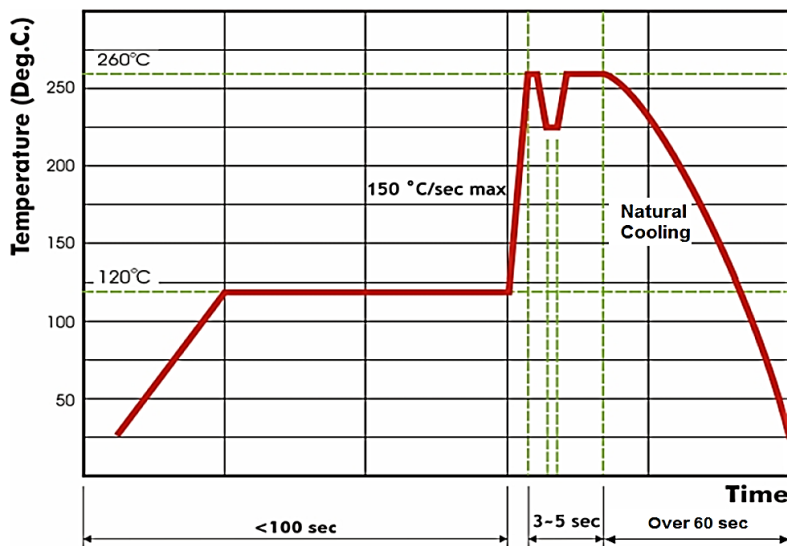

Wave Soldering Profile For SMT Process with SnAgCu series Solder Paste

## STORAGE AND HANDLING CONDITIONS

- To store products at 5 to 40°C ambient temperature and 20 to 70% related humidity conditions.
- The product is recommended to be used within one year after shipment. Check solder ability in case of shelf life extension is needed.
- Don't open the tape until the parts are to be used, use the chips within 3 months after the tape is opened.
- For product of high dielectric constant (Class2 & 3, characteristics B/W & Y), the Electro static capacity changes with the passage of time due to the inherent characteristics of ceramic dielectric materials. The changed capacity reverts to nominal at the temperature it reaches during the soldering process.

## CAUTIONS

- The corrosive gas reacts on the terminal electrodes of capacitors, and results in the poor solder ability. Do not store the capacitors in the ambience of corrosive gas (e.g., hydrogen sulfide, sulfur dioxide, chlorine, ammonia gas etc.)
- In corrosive atmosphere, solder ability might be degraded, and silver migration might occur to cause low reliability.
- Due to the dewing by rapid humidity change, or the photochemical change of the terminal electrode by direct sun light, the solder ability and electrical performance may deteriorate. Do not store capacitors under direct sunlight or dewing condition. To store products on the shelf and avoid exposure to moisture.

**TAPE DIMENSION** (Unit: mm)

Paper Tape

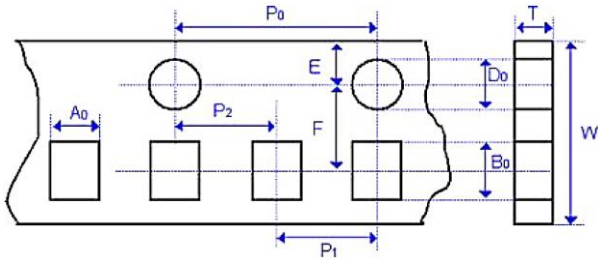

Plastic Tape

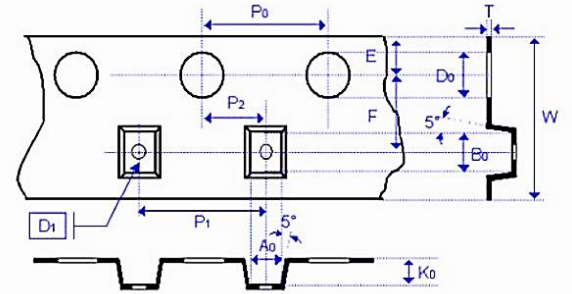

SIZE	0201	0402	0603	0805		
Thickness	L	H	H, S, B, X	A, H	B, X	C
A0	0.40 ±0.10	0.70 ±0.20	1.05 ±0.30	1.5±0.20	1.5 ±0.20	< 1.80
B0	0.70 ±0.10	1.20 ±0.20	1.80 ±0.30	2.30 ±0.20	2.30 ±0.20	< 2.70
T	≤0.55	≤0.80	≤1.20	≤1.15	≤1.20	0.23 ±0.1
K0	-	-	-	-	-	< 2.50
W	8.00 ±0.30	8.00 ±0.30	8.00 ±0.30	8.00 ±0.30	8.00 ±0.30	8.00 ±0.30
P0	4.00 ±0.10	4.00 ±0.10	4.00 ±0.10	4.00 ±0.10	4.00 ±0.10	4.00 ±0.10
10xP0	40.0 ±0.10	40.0 ±0.10	40.0 ±0.20	40.0 ±0.20	40.0 ±0.20	40.0 ±0.20
P1	2.00 ±0.05	2.00 ±0.05	4.00 ±0.10	4.00 ±0.10	4.00 ±0.10	4.00 ±0.10
P2	2.00 ±0.05	2.00 ±0.05	2.00 ±0.05	2.00 ±0.05	2.00 ±0.05	2.00 ±0.05
D0	1.50 +0.1/-0	1.50 +0.1/-0	1.50 +0.1/-0	1.50 +0.1/-0	1.50 +0.1/-0	1.50 +0.1/-0
D1	-	-	-	-	-	1.00 ±0.10
E	1.75 ±0.10	1.75 ±0.10	1.75 ±0.10	1.75 ±0.10	1.75 ±0.10	1.75 ±0.10
F	3.50 ±0.05	3.50 ±0.05	3.50 ±0.05	3.50 ±0.05	3.50 ±0.05	3.50 ±0.05

**TAPE DIMENSION** (Unit: mm)

SIZE	1206			1210		
	B	I, C, J	D, P	B	I, C, D, K	M
Thickness	B	I, C, J	D, P	B	I, C, D, K	M
A0	1.90 ±0.50	< 2.00	< 2.30	< 3.05	< 3.05	< 3.20
B0	3.50 ±0.50	< 3.70	< 4.00	< 3.80	< 3.80	< 4.00
T	≦1.20	0.23 ±0.1	0.23 ±0.1	0.23 ±0.1	0.23 ±0.1	0.23 ±0.1
K0	-	< 2.50	< 2.50	< 1.50	< 2.50	< 3.20
W	8.00 ±0.30	8.00 ±0.30	8.00 ±0.30	8.00 ±0.30	8.00 ±0.30	8.00 ±0.30
P0	4.00 ±0.10	4.00 ±0.10	4.00 ±0.10	4.00 ±0.10	4.00 ±0.10	4.00 ±0.10
10xP0	40.0 ±0.20	40.0 ±0.20	40.0 ±0.20	40.0 ±0.20	40.0 ±0.20	40.0 ±0.20
P1	4.00 ±0.10	4.00 ±0.10	4.00 ±0.10	4.00 ±0.10	4.00 ±0.10	4.00 ±0.10
P2	2.00 ±0.05	2.00 ±0.05	2.00 ±0.05	2.00 ±0.05	2.00 ±0.05	2.00 ±0.05
D0	1.50 +0.1/-0	1.50 +0.1/-0	1.50 +0.1/-0	1.50 +0.1/-0	1.50 +0.1/-0	1.50 +0.1/-0
D1	-	1.00 ±0.10	1.00 ±0.10	1.00 ±0.10	1.00 ±0.10	1.00 ±0.10
E	1.75 ±0.10	1.75 ±0.10	1.75 ±0.10	1.75 ±0.10	1.75 ±0.10	1.75 ±0.10
F	3.50 ±0.05	3.50 ±0.05	3.50 ±0.05	3.50 ±0.05	3.50 ±0.05	3.50 ±0.05

**TAPE DIMENSION** (Unit: mm)

SIZE	1812		1825		2220	
Thickness	C, D, K	M, U	K	M, U	K	M, U
A0	< 3.90	< 3.90	< 6.80	< 6.80	< 5.80	< 5.80
B0	< 5.30	< 5.30	< 5.30	< 5.30	< 6.50	< 6.50
T	0.25 ±0.1	0.25 ±0.1	0.30 ±0.1	0.30 ±0.1	0.30 ±0.1	0.30 ±0.1
K0	< 2.50	< 3.50	< 2.50	< 3.50	< 2.50	< 3.50
W	12±0.30	12±0.30	12±0.30	12±0.30	12±0.30	12±0.30
P0	4.00 ±0.10	4.00 ±0.10	4.00 ±0.10	4.00 ±0.10	4.00 ±0.10	4.00 ±0.10
10xP0	40.0 ±0.20	40.0 ±0.20	40.0 ±0.20	40.0 ±0.20	40.0 ±0.20	40.0 ±0.20
P1	8.00 ±0.10	8.00 ±0.10	8.00 ±0.10	8.00 ±0.10	8.00 ±0.10	8.00 ±0.10
P2	2.00 ±0.10	2.00 ±0.10	2.00 ±0.10	2.00 ±0.10	2.00 ±0.10	2.00 ±0.10
D0	1.50 +0.1/-0	1.50 +0.1/-0	1.50 +0.1/-0	1.50 +0.1/-0	1.50 +0.1/-0	1.50 +0.1/-0
D1	1.50 ±0.10	1.50 ±0.10	1.50 ±0.10	1.50 ±0.10	1.50 ±0.10	1.50 ±0.10
E	1.75 ±0.10	1.75 ±0.10	1.75 ±0.10	1.75 ±0.10	1.75 ±0.10	1.75 ±0.10
F	5.50 ±0.10	5.50 ±0.10	5.50 ±0.05	5.50 ±0.05	5.50 ±0.05	5.50 ±0.05



**TAPE DIMENSION** (Unit: mm)

SIZE	2225	
	K	M, U
Thickness		
A0	< 6.80	< 6.80
B0	< 6.50	< 6.50
T	0.30 ±0.1	0.30 ±0.1
K0	< 2.50	< 3.50
W	12±0.30	12±0.30
P0	4.00 ±0.10	4.00 ±0.10
10xP0	40.0 ±0.20	40.0 ±0.20
P1	8.00 ±0.10	8.00 ±0.10
P2	2.00 ±0.10	2.00 ±0.10
D0	1.50 +0.1/-0	1.50 +0.1/-0
D1	1.50 ±0.10	1.50 ±0.10
E	1.75 ±0.10	1.75 ±0.10
F	5.50 ±0.05	5.50 ±0.05

**REEL DIMENSION** (Unit: mm)

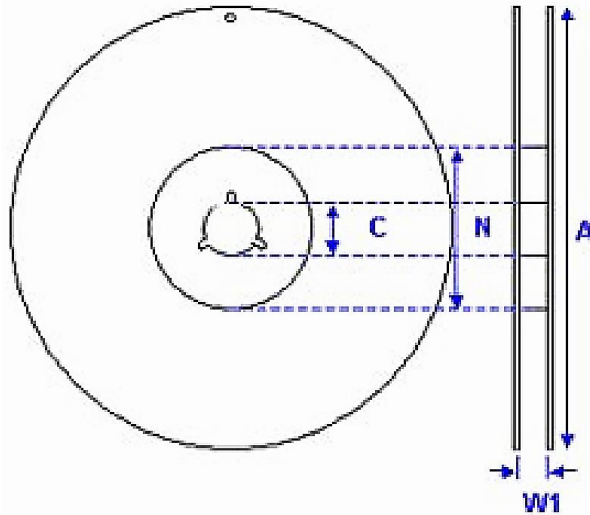

SIZE CODE	0201, 0402, 0603, 0805, 1206, 1210			1812, 1825, 2220, 2225
Reel Size	7"	10"	13"	7"
C	13.0+0.5/-0.2	13.0+0.5/-0.2	13.0+0.5/-0.2	13.0+0.5/-0.2
W 1	8.4+1.5/-0	8.4+1.5/-0	8.4+1.5/-0	12.4+2.0/-0
A	178.0±0.10	250.0±1.0	330.0±1.0	178.0±0.10
N	60.0+1.0/-0	100.0±1.0	100±1.0	60.0+1.0/-0

**PACKAGING STYLE AND QUANTITY PER REEL**

SIZE	THICKNESS (SYMBOL) (MM)		PAPER TAPE		PLASTIC TAPE	
			7" REEL	13" REEL	7" REEL	13" REEL
0201 (0603)	0.30±0.09	L	15,000	-	-	-
			15,000	-	-	-
			15,000	-	-	-
0402 (1005)	0.50±0.05	N	10,000	50,000	-	-
	0.50±0.10	E	10,000	50,000	-	-
	0.50±0.20	H	10,000	-	-	-
0603 (1608)	0.50±0.20	H	4,000	-	-	-
	0.80±0.10	S	4,000	15,000	-	-
	0.80±0.20	X	4,000	15,000	-	-
0805 (2012)	0.50±0.20	N	4,000	15,000	-	-
	0.60±0.10	A	4,000	15,000	-	-
	0.85±0.15	B	4,000	15,000	-	-
	1.25±0.15	C	-	-	3,000	10,000
1206 (3216)	0.85±0.15	B	4,000	15,000	-	-
	0.95±0.10	I	-	-	3,000	10,000
	1.15±0.15	J	-	-	3,000	10,000
	1.25±0.20	C	-	-	3,000	10,000
	1.60±0.15	D	-	-	2,000	10,000
	1.60+0.30/-0.10	P	-	-	2,000	9,000
1210 (3225)	0.85±0.15	B	-	-	3,000	10,000
	0.95±0.10	I	-	-	3,000	10,000
	1.25±0.20	C	-	-	3,000	10,000
	1.60±0.20	D	-	-	2,000	-
	2.00±0.20	K	-	-	1,000	6,000
	2.50±0.30	M	-	-	1,000	6,000

**PACKAGING STYLE AND QUANTITY PER REEL**

SIZE	THICKNESS (SYMBOL) (MM)		PAPER TAPE		PLASTIC TAPE	
			7" REEL	13" REEL	7" REEL	13" REEL
1808 (4520)	1.25±0.20	C	-	-	2,000	10,000
	1.60±0.20	D	-	-	2,000	8,000
	2.00±0.20	K	-	-	1,000	6,000
1812 (4532)	1.25±0.20	C	-	-	1,000	5,000
	1.60±0.20	D	-	-	1,000	-
	2.00±0.20	K	-	-	1,000	-
	2.50±0.30	M	-	-	500	3,000
	2.80±0.30	U	-	-	500	-
1825 (4563)	2.00±0.20	K	-	-	1,000	-
2220 (5750)	2.50±0.30	M	-	-	500	-
2225 (5763)	2.80±0.30	U	-	-	500	-

## IMPORTANT NOTES AND DISCLAIMER

1. **ROHS COMPLIANCE:** The levels of RoHS restricted materials in this product are below the maximum concentration values (also referred to as the threshold limits) permitted for such substances, or are used in an exempted application, in accordance with EU RoHS Directive (EU) 2015/863 EC (RoHS3). RoHS Test Report for this product can be obtained at Download Center.
2. **REACH COMPLIANCE:** REACH substances of high concern (SVHCs) information is available for this product. Since the European Chemical Agency (ECHA) has published notice of their intent to frequently revise the SVHC listing for the foreseeable future, REACH Test Report for this product can be obtained at Download Center.
3. All Product parametric performance is indicated in the Electrical Characteristics for the listed herein test conditions, unless otherwise noted. Product performance may not be indicated by the Electrical Characteristics if operated under different conditions.
4. NextGen Component, Inc (*NextGen*) reserves the right to make changes to this document and its products and specifications at any time without notice. Customers should obtain and confirm the latest product information and specifications before final design, purchase or use.
5. *NextGen* makes no warranty, representation or guarantee regarding the suitability of its products for any particular purpose, not does *NextGen* assume any liability for application assistance or customer product design.
6. *NextGen* does not warrant or accept any liability with products which are purchased or used for any unintended or unauthorized application. No license is granted by implication or otherwise under any intellectual property rights of NextGen.
7. *NextGen* products are not authorized for use as critical components in life support devices or systems without express written approval by *NextGen*.
8. *NextGen* requires that customers first obtain an RMA (Returned Merchandise Authorization) number prior to returning any products. Returns must be made within 30 days of the date of invoice, be in the original packaging, unused and like-new condition. At the time of quoting or purchasing, a product may say that it is Non-Cancelable/ Non-Returnable (NCNR). These products are not returnable and not refundable.