



| | | |
|---|---|--|
| SPECIFICATION SHEET NO. | R1224 - XH25M00000S416 | |
| ORIGINAL MFG/PART NO. | TGS Crystals/CSSX 25M0A30-16-50-40-30 TLH/AH3 | |
| NEXTGEN PART CODE | XH25M00000S416 | Indicate This Code For RFQ/Order |
| DATE | Dec. 24, 2024 | |
| REVISION | A3 | Updated With Most Recent Data |
| DESCRIPTION AND MAIN PARAMETRICS | <p>MHz SMD Crystal 4 pads, Hold Type HC-49SX, XH series, Resistance Weld Metal Case, Dimension L12.5*W4.95*H4.0mm 25.000MHz, Tolerance ±30ppm, Load Capacitor 16pF Frequency stability ±50ppm; Operating Temp. Range -40°C ~+85°C, ESR 30 ohm Max, Reflow Profile Condition 260 °C Max. Package in Tape/Reel, 1000pcs/Reel RoHS/RoHS III compliant, RoHS Annex III lead Exemption (exempt per RoHS EU 2015/863)</p> | |
| CUSTOMER | | |
| CUSTOMER PART NUMBER | | |
| CROSS REF. PART NUMBER | EPSON 406 & 506 | |
| MEMO | | |

| | | |
|-------------------------------|---|--|
| VENDOR APPROVE | | |
| Issued/Checked/Approved |  |   |
| Effective Date: Dec. 24, 2024 | | |

| | |
|-------------------------|--|
| CUSTOMER APPROVE | |
| | |
| Date: | |

MAIN FEATURE

- MHz SMD Crystal L12.5*W4.95*H4.0mm 4 Pads
- Resistance Weld Metal Case, Hold Type HC-49SX,
- Low Profile and Short Lead time
- RoHS/RoHS III Compliant, RoHS Annex III Lead Exemption
(exempt per RoHS EU 2015/863)
- Moisture Sensitivity Level (MSL) Level 1
- Excellent Aging and Wide Frequency Range
- 4 Pad Fit EPSON 406 & 506 Footprint Surface Mount
- Replace MHz SMD Plastic Crystal, YQ/CCME series



Image shown is a representation only. Exact specifications should be obtained from the product dimension.



APPLICATION

- Microcontroller Systems, Microprocessors, Communication Interfaces
- Digital Signal Processors (DSPs), Test And Measurement Equipment

ELECTRICAL CHARACTERISTICS

- See Page 7 ~Page 11 For Different Part Code And Rated Voltage.
- All Products Parameters are Subject To NextGen Components' Final Confirmation.

HOW TO ORDER

- Please Follow Up Part Code Guide And Indicate NextGen Part Code XH25M00000S416 For RFQ and Order.

PART CODE GUIDE

RFQ
[Request For Quotation](#)

| CODE | NAME | KEY SPECIFICATION OPTION |
|-------|-----------------------------------|---|
| XH | Series Code | MHz SMD Crystal L12.5*W4.95*H4.0mm 4 Pads Hold Type HC-49SX |
| 25M0 | Frequency Range Code | 25M0: 25.0MHz or Custom Frequency Range by Page 7~ Page 11 |
| 0000S | Internal Control Code | Letter A~Z, a~z or digits (0~9) |
| 416 | Parameters code | Special Parameters Code Letter A~Z, a~z or digits (1-9) |
| () | Special/Custom Parameters Code | Blank: N/A XX: Letter A~Z, a~z or digits (0~9) for Special/Custom Parameters |

DIMENSION (Unit: mm)

Top View



Bottom View



Side View

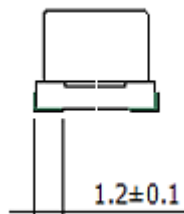

Solder Pattern

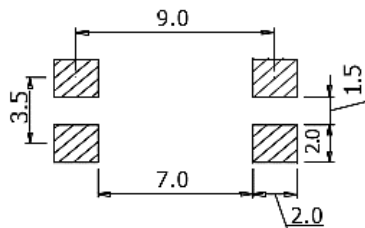

INSIDE STRUCTURE



| CODE | NAME |
|------|---------------------|
| 1 | Cover |
| 2 | Base |
| 3 | Pad |
| 4 | Glass Insulator |
| 5 | Clip |
| 6 | Quartz Blank |
| 7 | Electrode |
| 8 | Conductive Adhesive |
| 9 | Plastic Board |

GENERAL SPECIFICATION

| PARAMETER | SYMBOL | VALUE | | | UNIT | CONDITION |
|------------------------------|---------------|-------------|----------|----------|------------|----------------------------|
| | | MIN. | TYPE | MAX. | | |
| Frequency Range | F0 | 3.072 | - | 100.00 | MHz | Customer specified |
| Mode of Vibration Code | | Fundamental | | | | Optional: 3rd OT Or 5th OT |
| Frequency Tolerance | $\Delta F/F0$ | ± 10 | ± 30 | ± 30 | ppm | at 25°C ± 3 °C |
| Load Capacitance | CL | 6 | 20 | Series | pF | Customer specified |
| Frequency Stability | Tc | ± 30 | ± 50 | ± 50 | ppm | Customer specified |
| Operating Temp. Range | TOPR | -40 | - | +85 | °C | Standard |
| Storage Temp. Range | TSTG | -40 | - | +85 | °C | |
| Equivalent Series Resistance | ESR | See Table 1 | | | Ω | Customer specified |
| Drive Level | DL | - | - | 100 | μW | |
| Insulation Resistance | IR | 500 | - | | m Ω | At 100VDC |
| Shunt Capacitance | C0 | - | - | 7.0 | pF | |
| Aging per year | Fa | -5 | - | +5 | ppm | 1st Year |

Table 1

| FREQUENCY RANGE | MODE OF VIBRATION | ESR (Ω) MAX |
|-------------------------------------|-------------------|----------------------|
| 3.072MHz \leq F0 \leq 4.000MHz | Fundamental | < 200 |
| 4.000MHz < F0 \leq 6.000MHz | Fundamental | < 80 |
| 6.000MHz < F0 \leq 8.000MHz | Fundamental | < 50 |
| 8.00MHz < F0 \leq 16.000MHz | Fundamental | < 40 |
| 16.00MHz < F0 \leq 48.00MHz | Fundamental | < 30 |
| 24.00MHz < F0 \leq 40.00MHz | 3rd Overtone | < 100 |
| 40.00MHz < F0 \leq 80.00MHz | 3rd Overtone | < 50 |
| 50.00MHz \leq F0 \leq 100.00MHz | 5th Overtone | < 100 |

ELECTRICAL PARAMETERS – FOR DIFFERENT PART CODE- Ta = 25°C

| PART CODE | FREQUENCY RANGE | FREQUENCY TOLERANCE | LOAD CAPACITANCE | FREQUENCY STABILITY | OPERATING TEMPE. RANGE | EQUIVALENT SERIES RESISTANCE |
|----------------|-----------------|---------------------|------------------|---------------------|------------------------|------------------------------|
| | MHz | ppm | pF | ppm | °C | Ω Max. |
| XH3M579545S416 | 3.579545 | ±30 | 16 | ±50 | -40 ~ +85 | 200 |
| XH3M579545S418 | 3.579545 | ±30 | 18 | ±50 | -40 ~ +85 | 200 |
| XH3M579545S420 | 3.579545 | ±30 | 20 | ±50 | -40 ~ +85 | 200 |
| XH3M686400S416 | 3.686400 | ±30 | 16 | ±50 | -40 ~ +85 | 200 |
| XH3M686400S418 | 3.686400 | ±30 | 18 | ±50 | -40 ~ +85 | 200 |
| XH3M686400S420 | 3.686400 | ±30 | 20 | ±50 | -40 ~ +85 | 200 |
| XH4M000000S410 | 4.000000 | ±30 | 10 | ±50 | -40 ~ +85 | 200 |
| XH4M000000S416 | 4.000000 | ±30 | 16 | ±50 | -40 ~ +85 | 200 |
| XH4M000000S418 | 4.000000 | ±30 | 18 | ±50 | -40 ~ +85 | 200 |
| XH4M000000S420 | 4.000000 | ±30 | 20 | ±50 | -40 ~ +85 | 200 |
| XH4M915200S416 | 4.915200 | ±30 | 16 | ±50 | -40 ~ +85 | 80 |
| XH4M915200S418 | 4.915200 | ±30 | 18 | ±50 | -40 ~ +85 | 80 |
| XH4M915200S420 | 4.915200 | ±30 | 20 | ±50 | -40 ~ +85 | 80 |
| XH6M000000S416 | 6.000000 | ±30 | 16 | ±50 | -40 ~ +85 | 80 |
| XH6M000000S418 | 6.000000 | ±30 | 18 | ±50 | -40 ~ +85 | 80 |
| XH6M000000S420 | 6.000000 | ±30 | 20 | ±50 | -40 ~ +85 | 80 |
| XH6M144000S418 | 6.144000 | ±30 | 18 | ±50 | -40 ~ +85 | 50 |
| XH7M372800S416 | 7.372800 | ±30 | 16 | ±50 | -40 ~ +85 | 50 |
| XH7M372800S418 | 7.372800 | ±30 | 18 | ±50 | -40 ~ +85 | 50 |
| XH7M372800S420 | 7.372800 | ±30 | 20 | ±50 | -40 ~ +85 | 50 |

ELECTRICAL PARAMETERS – FOR DIFFERENT PART CODE- Ta = 25°C

| PART CODE | FREQUENCY RANGE | FREQUENCY TOLERANCE | LOAD CAPACITANCE | FREQUENCY STABILITY | OPERATING TEMPE. RANGE | EQUIVALENT SERIES RESISTANCE |
|-----------------|-----------------|---------------------|------------------|---------------------|------------------------|------------------------------|
| | MHz | ppm | pF | ppm | °C | Ω Max. |
| XH8M000000S416 | 8.000000 | ±30 | 16 | ±50 | -40 ~ +85 | 50 |
| XH8M000000S418 | 8.000000 | ±30 | 18 | ±50 | -40 ~ +85 | 50 |
| XH8M000000S420 | 8.000000 | ±30 | 20 | ±50 | -40 ~ +85 | 50 |
| XH8M000000S40S | 8.000000 | ±30 | Series | ±50 | -40 ~ +85 | 50 |
| XH8M192000S416 | 8.192000 | ±30 | 16 | ±50 | -40 ~ +85 | 40 |
| XH8M192000S418 | 8.192000 | ±30 | 18 | ±50 | -40 ~ +85 | 40 |
| XH8M192000S420 | 8.192000 | ±30 | 20 | ±50 | -40 ~ +85 | 40 |
| XH9M216000S416 | 9.216000 | ±30 | 16 | ±50 | -40 ~ +85 | 40 |
| XH9M216000S418 | 9.216000 | ±30 | 18 | ±50 | -40 ~ +85 | 40 |
| XH9M216000S420 | 9.216000 | ±30 | 20 | ±50 | -40 ~ +85 | 40 |
| XH9M830400S416 | 9.830400 | ±30 | 16 | ±50 | -40 ~ +85 | 40 |
| XH9M830400S418 | 9.830400 | ±30 | 18 | ±50 | -40 ~ +85 | 40 |
| XH9M830400S420 | 9.830400 | ±30 | 20 | ±50 | -40 ~ +85 | 40 |
| XH10M000000S416 | 10.000000 | ±30 | 16 | ±50 | -40 ~ +85 | 40 |
| XH10M000000S418 | 10.000000 | ±30 | 18 | ±50 | -40 ~ +85 | 40 |
| XH10M000000S420 | 10.000000 | ±30 | 20 | ±50 | -40 ~ +85 | 40 |
| XH10M000000S40S | 10.000000 | ±30 | Series | ±50 | -40 ~ +85 | 40 |
| XH11M05920S416 | 11.059200 | ±30 | 16 | ±50 | -40 ~ +85 | 40 |
| XH11M05920S418 | 11.059200 | ±30 | 18 | ±50 | -40 ~ +85 | 40 |
| XH11M05920S420 | 11.059200 | ±30 | 20 | ±50 | -40 ~ +85 | 40 |

ELECTRICAL PARAMETERS – FOR DIFFERENT PART CODE- Ta = 25°C

| PART CODE | FREQUENCY RANGE | FREQUENCY TOLERANCE | LOAD CAPACITANCE | FREQUENCY STABILITY | OPERATING TEMPE. RANGE | EQUIVALENT SERIES RESISTANCE |
|----------------|-----------------|---------------------|------------------|---------------------|------------------------|------------------------------|
| | MHz | ppm | pF | ppm | °C | Ω Max. |
| XH12M00000S416 | 12.000000 | ±30 | 16 | ±50 | -40 ~ +85 | 40 |
| XH12M00000S418 | 12.000000 | ±30 | 18 | ±50 | -40 ~ +85 | 40 |
| XH12M00000S420 | 12.000000 | ±30 | 20 | ±50 | -40 ~ +85 | 40 |
| XH12M00000S40S | 12.000000 | ±30 | Series | ±50 | -40 ~ +85 | 40 |
| XH12M28800S416 | 12.288000 | ±30 | 16 | ±50 | -40 ~ +85 | 40 |
| XH12M28800S418 | 12.288000 | ±30 | 18 | ±50 | -40 ~ +85 | 40 |
| XH12M28800S420 | 12.288000 | ±30 | 20 | ±50 | -40 ~ +85 | 40 |
| XH12M500S33418 | 12.500000 | ±30 | 18 | ±30 | -40 ~ +85 | 40 |
| XH14M31818S416 | 14.318180 | ±30 | 16 | ±50 | -40 ~ +85 | 40 |
| XH14M31818S418 | 14.318180 | ±30 | 18 | ±50 | -40 ~ +85 | 40 |
| XH14M31818S420 | 14.318180 | ±30 | 20 | ±50 | -40 ~ +85 | 40 |
| XH14M74560S416 | 14.745600 | ±30 | 16 | ±50 | -40 ~ +85 | 40 |
| XH14M74560S418 | 14.745600 | ±30 | 18 | ±50 | -40 ~ +85 | 40 |
| XH14M74560S420 | 14.745600 | ±30 | 20 | ±50 | -40 ~ +85 | 40 |
| XH16M00000S416 | 16.000000 | ±30 | 16 | ±50 | -40 ~ +85 | 40 |
| XH16M00000S418 | 16.000000 | ±30 | 18 | ±50 | -40 ~ +85 | 40 |
| XH16M00000S420 | 16.000000 | ±30 | 20 | ±50 | -40 ~ +85 | 40 |
| XH16M38400S416 | 16.384000 | ±30 | 16 | ±50 | -40 ~ +85 | 30 |
| XH16M38400S418 | 16.384000 | ±30 | 18 | ±50 | -40 ~ +85 | 30 |
| XH16M38400S420 | 16.384000 | ±30 | 20 | ±50 | -40 ~ +85 | 30 |

ELECTRICAL PARAMETERS – FOR DIFFERENT PART CODE- Ta = 25°C

| PART CODE | FREQUENCY RANGE | FREQUENCY TOLERANCE | LOAD CAPACITANCE | FREQUENCY STABILITY | OPERATING TEMPE. RANGE | EQUIVALENT SERIES RESISTANCE |
|----------------|-----------------|---------------------|------------------|---------------------|------------------------|------------------------------|
| | MHz | ppm | pF | ppm | °C | Ω Max. |
| XH18M00000S418 | 18.000000 | ±30 | 18 | ±50 | -40 ~ +85 | 30 |
| XH18M43200S416 | 18.432000 | ±30 | 16 | ±50 | -40 ~ +85 | 30 |
| XH18M43200S418 | 18.432000 | ±30 | 18 | ±50 | -40 ~ +85 | 30 |
| XH18M43200S420 | 18.432000 | ±30 | 20 | ±50 | -40 ~ +85 | 30 |
| XH19M66080S416 | 19.660800 | ±30 | 16 | ±50 | -40 ~ +85 | 30 |
| XH19M66080S418 | 19.660800 | ±30 | 18 | ±50 | -40 ~ +85 | 30 |
| XH19M66080S420 | 19.660800 | ±30 | 20 | ±50 | -40 ~ +85 | 30 |
| XH20M00000S416 | 20.000000 | ±30 | 16 | ±50 | -40 ~ +85 | 30 |
| XH20M00000S418 | 20.000000 | ±30 | 18 | ±50 | -40 ~ +85 | 30 |
| XH20M00000S420 | 20.000000 | ±30 | 20 | ±50 | -40 ~ +85 | 30 |
| XH22M11840S416 | 22.118400 | ±30 | 16 | ±50 | -40 ~ +85 | 30 |
| XH22M11840S418 | 22.118400 | ±30 | 18 | ±50 | -40 ~ +85 | 30 |
| XH22M11840S420 | 22.118400 | ±30 | 20 | ±50 | -40 ~ +85 | 30 |
| XH24M00000S416 | 24.000000 | ±30 | 16 | ±50 | -40 ~ +85 | 30 |
| XH24M00000S418 | 24.000000 | ±30 | 18 | ±50 | -40 ~ +85 | 30 |
| XH24M00000S420 | 24.000000 | ±30 | 20 | ±50 | -40 ~ +85 | 30 |
| XH24M00000S40S | 24.000000 | ±30 | Series | ±50 | -40 ~ +85 | 30 |
| XH24M57600S416 | 24.576000 | ±30 | 16 | ±50 | -40 ~ +85 | 30 |
| XH24M57600S418 | 24.576000 | ±30 | 18 | ±50 | -40 ~ +85 | 30 |
| XH24M57600S420 | 24.576000 | ±30 | 20 | ±50 | -40 ~ +85 | 30 |

ELECTRICAL PARAMETERS – FOR DIFFERENT PART CODE- Ta = 25°C

| PART CODE | FREQUENCY RANGE | FREQUENCY TOLERANCE | LOAD CAPACITANCE | FREQUENCY STABILITY | OPERATING TEMPE. RANGE | EQUIVALENT SERIES RESISTANCE |
|--------------------------------|-----------------|---------------------|------------------|---------------------|------------------------|------------------------------|
| | MHz | ppm | pF | ppm | °C | Ω Max. |
| XH25M00000S416 | 25.000000 | ±30 | 16 | ±50 | -40 ~ +85 | 30 |
| XH25M00000S418 | 25.000000 | ±30 | 18 | ±50 | -40 ~ +85 | 30 |
| XH25M00000S420 | 25.000000 | ±30 | 20 | ±50 | -40 ~ +85 | 30 |
| XH26M00000S416 | 26.000000 | ±30 | 16 | ±50 | -40 ~ +85 | 30 |
| XH26M00000S418 | 26.000000 | ±30 | 18 | ±50 | -40 ~ +85 | 30 |
| XH26M00000S420 | 26.000000 | ±30 | 20 | ±50 | -40 ~ +85 | 30 |
| XH27M00000S416 | 27.000000 | ±30 | 16 | ±50 | -40 ~ +85 | 30 |
| XH27M00000S418 | 27.000000 | ±30 | 18 | ±50 | -40 ~ +85 | 30 |
| XH27M00000S420 | 27.000000 | ±30 | 20 | ±50 | -40 ~ +85 | 30 |
| XH28M37500S416 | 28.375000 | ±30 | 16 | ±50 | -40 ~ +85 | 30 |
| XH28M37500S418 | 28.375000 | ±30 | 18 | ±50 | -40 ~ +85 | 30 |
| XH28M37500S420 | 28.375000 | ±30 | 20 | ±50 | -40 ~ +85 | 30 |
| XH30M00000S416 | 30.000000 | ±30 | 16 | ±50 | -40 ~ +85 | 30 |
| XH30M00000S418 | 30.000000 | ±30 | 18 | ±50 | -40 ~ +85 | 30 |
| XH30M00000S420 | 30.000000 | ±30 | 20 | ±50 | -40 ~ +85 | 30 |
| XH32M00000S416 | 32.000000 | ±30 | 16 | ±50 | -40 ~ +85 | 30 |
| XH32M00000S418 | 32.000000 | ±30 | 18 | ±50 | -40 ~ +85 | 30 |
| XH32M00000S420 | 32.000000 | ±30 | 20 | ±50 | -40 ~ +85 | 30 |
| XH40M00000S416 | 40.000000 | ±30 | 16 | ±50 | -40 ~ +85 | 30 |
| XH40M00000S418 | 40.000000 | ±30 | 18 | ±50 | -40 ~ +85 | 30 |
| XH40M00000S420 | 40.000000 | ±30 | 20 | ±50 | -40 ~ +85 | 30 |

CHARACTERISTICS

Units and values indicated with { } in this specification are the former units and the specified values.

Standard Atmospheric Conditions:

Unless otherwise specified the standard range of atmospheric conditions for making measurements and tests is as follows:

Ambient temperature: 15°C to 35°C

Relative humidity : 25% to 85%

Air pressure : 86 to 106 k Pa

If there is any doubt about the results measurements shall be made within the following limits:

Ambient temperature : $25 \pm 1^\circ\text{C}$

Relative humidity : 63% to 67%

Air pressure : 86 to 106 k Pa

Operating Temperature Range:

The operating temperature range is the range of ambient temperatures at which the quartz crystal oscillator can be stored without damage. Conditions are as specified elsewhere on these specifications.

Operating temperature range: -40°C to +85°C

Storage Temperature Range:

The storage temperature range is the range of ambient temperatures at which the quartz crystal oscillator can be stored without damage. Conditions are as specified elsewhere on these specifications.

Storage temperature range: -55°C to +125°C

MECHANICAL CHARACTERISTICS

Provided that measurement shall be carried out after letting it alone in the room temperature for 1h.

| TEST ITEMS | TEST METHOD AND CONDITIONS |
|------------------------------|---|
| Shock | Dropping three times from the height of 50cm onto hard wooden board of thickness more than 30mm. |
| Vibration | a) Vibration Frequency: 10 To 55hz b) Vibration Amplitude: 0.8mm c) Cycle Time: 1~2min(10-55-10hz) d) Direction: X.Y.Z e) Duration: 2h/Each Direction, total 6Hours |
| Terminal Strength | Pulling: a) Body of specimen shall be fixed and 8.82N of tension weight shall be supplied gradually to axial direction of terminals/lead-wires for 30s b) After above test a)there is no observation of any visual damages on the specimen Bending: a) Body of specimen shall be fixed and 90 degree bending shall be given being supplied 225g tension weight, After that terminals lead-wires shall be straightened gradually Then the same bending and straightening shall be supplied to the opposite direction in the same axial b) After above tesla)there is no observation of any visual damages on the specimen |
| Sealing Tightness | There is no observation of gas bubble after specimen put into alcohol below 1atm for 3 min. |
| Solder ability | Terminals/lead-wires of specimen shall be dipped into solder melted tank at 230±5°C for 3±0.5sec. Dipping depth shall be 2mm from the bottom of specimen's body. (After applying ROSIN flux) Soldering portion shall be covered in over 90% of terminals/lead-wires dipped |
| Resistance to Soldering Heat | Terminals/lead-wires of specimen shall be dipped into solder melted tank at 350 ± 10°C for 3-4sec. or 260 ± 5°C for 5 ± 1sec |

Note:

- 1) Frequency variation shall be within ±5ppm and equivalent resistance less than ±15% max after the test
- 2) Measuring the frequency should be done after keeping test samples at room temperature for 24 hours

ENVIRONMENTAL CHARACTERISTICS

Provided that measurement shall be carried out after letting it alone in the room temperature for 1h.

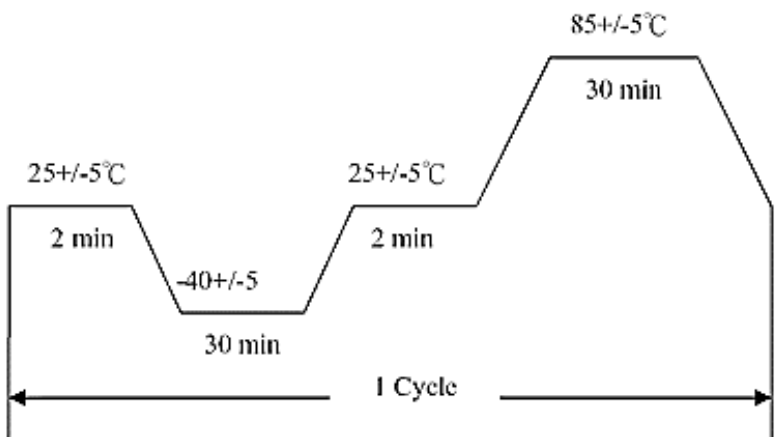
| TEST ITEMS | TEST METHOD AND CONDITIONS |
|-----------------------------|---|
| Humidity Storage | It alone at 40°C±2°C in humidity of 90~95% for 48h |
| Storage in Low Temperature | It alone at -40°C±2°C for 240h |
| Storage in High Temperature | It alone at -85°C±2°C for 240h |
| Temperature Cycle | <p>The following temperature cycle (10 cycles) Refer to below Fig. Temperature shift from low to high, high to low shall be done in 1°C/C /min.</p>  |

Note:

- 1) Frequency variation shall be within ±5ppm and equivalent resistance less than ±15% max after the test
- 2) Measuring the frequency should be done after keeping test samples at room temperature for 24 hours

SUGGESTED REFLOW PROFILE (For Reference Only)



| PROFILE FEATURE | | HIGH-PB ASSEMBLY |
|--|----------------------------------|-------------------|
| Average Ramp-up Rate (T_s Max to T_p) | | 3°C/second Max |
| Preheat | Temperature Min (T_s Min.) | 140°C |
| | Temperature Max (T_s Max.) | 180°C |
| | Time (t_s Min. to t_s Max.) | 70 ~ 100 seconds |
| Time maintained above | Temperature (T_L) | 240°C |
| | Time (t_L) | 20 ~ 50 seconds |
| Peak/Classification Temperature (T_p) | | 260 °C |
| Time within 5°C of actual Peak Temperature (t_p) | | 5 ~ 6 seconds |
| Ramp-down rate | | 6 °C /Second Max. |
| Time 25 °C to Peak Temperature | | 6 minutes Max. |

NOTES

1. Only the lead should be heated when soldering. In case that the package temperature is exceeding 150°C it may impair the crystal or may e cause the crystal quartz 10 destroy.
2. Pulling the lead strongly may cause cracking of the hermetic grass seal bending the lead closely from the case may also cause same problem so when the lead needs to be bent please leave move than 05.mm of lead from the case.
3. Too much shock or vibration is not allowed. According to conditions such as machine shock during the assembly the internal quartz crystal might be damaged. Please check your conditions carefully when using it in advance.
4. Don't storage or use in the environment that temperature may change rapidly to avoid the condensation. And also we recommend to storage the products in the normal environment (Temperature humidity).
5. This product can be subjected to ultrasonic cleaning. However since the oscillator may be affected depending on the condition be sure to check it.
6. Applying excessive drive level to the quartz crystal may cause deterioration for characteristics or damage. Circuit design must be such as to maintain a proper drive level.
7. Unless adequate negative resistance is allocated in the oscillation circuit startup time of oscillation may be increased or no oscillation may occur In order to avoid this provide enough negative resistance in the circuitry design.

TAPE AND REEL (1000pcs/Reel, Unit: mm)

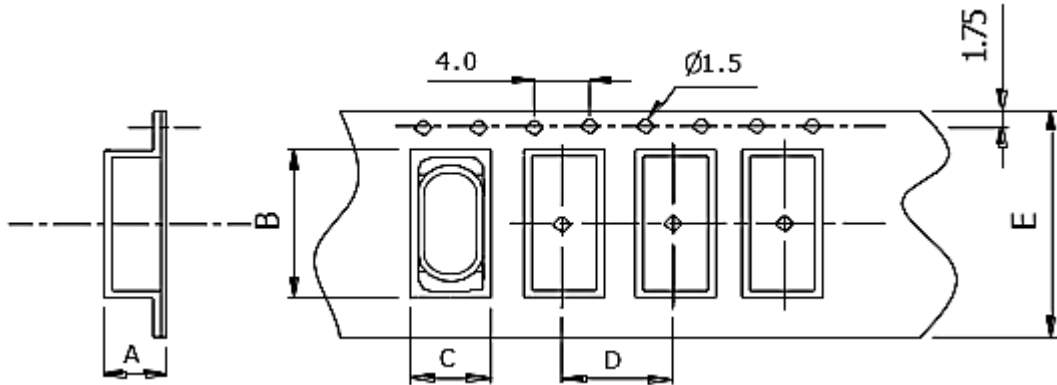

| F | E | D | C | B | A |
|-----------|------------|------------|-----------|-----------|-----------|
| 0.40±0.05 | 24.00±0.30 | 12.00±0.10 | 5.00±0.10 | 14.2±0.20 | 4.40±0.20 |



| A | B | C | D | N | W1 | T1 |
|-----------|-----------|------------|------------|------------|-----------|----------|
| φ330±0.20 | 2.50±0.50 | φ13.5±0.50 | φ21.0±1.00 | φ99.0±1.00 | 24.5±1.00 | 2.3±0.50 |

IMPORTANT NOTES AND DISCLAIMER

1. **ROHS COMPLIANCE:** The levels of RoHS restricted materials in this product are below the maximum concentration values (also referred to as the threshold limits) permitted for such substances, or are used in an exempted application, in accordance with EU RoHS Directive (EU) 2015/863 EC (RoHS3). RoHS Test Report for this product can be obtained at Download Center.
2. **REACH COMPLIANCE:** REACH substances of high concern (SVHCs) information is available for this product. Since the European Chemical Agency (ECHA) has published notice of their intent to frequently revise the SVHC listing for the foreseeable future, REACH Test Report for this product can be obtained at Download Center.
3. All Product parametric performance is indicated in the Electrical Characteristics for the listed herein test conditions, unless otherwise noted. Product performance may not be indicated by the Electrical Characteristics if operated under different conditions.
4. NextGen Component, Inc (*NextGen*) reserves the right to make changes to this document and its products and specifications at any time without notice. Customers should obtain and confirm the latest product information and specifications before final design, purchase or use.
5. *NextGen* makes no warranty, representation or guarantee regarding the suitability of its products for any particular purpose, not does *NextGen* assume any liability for application assistance or customer product design.
6. *NextGen* does not warrant or accept any liability with products which are purchased or used for any unintended or unauthorized application. No license is granted by implication or otherwise under any intellectual property rights of NextGen.
7. *NextGen* products are not authorized for use as critical components in life support devices or systems without express written approval by *NextGen*.
8. *NextGen* requires that customers first obtain an RMA (Returned Merchandise Authorization) number prior to returning any products. Returns must be made within 30 days of the date of invoice, be in the original packaging, unused and like-new condition. At the time of quoting or purchasing, a product may say that it is Non-Cancelable/ Non-Returnable (NCNR). These products are not returnable and not refundable.