



SPECIFICATION SHEET NO.	R1223-YP96K00000S103	
ORIGINAL MFG/PART NO.	TGS Crystals/CCMC 96K0A30-12.5-40-50TLH/PMX206/AM29600012504T6	
NEXTGEN PART CODE	YP96K00000S103	Indicate This Code For RFQ/Order
DATE	Dec. 23, 2024	
REVISION	A6	Updated With Most Recent Data
DESCRIPTION AND MAIN PARAMETRICS	<p>KHz SMD Crystals, Plastic Case, 8038, 4 pads, YP series</p> <p>Dimension: L8.0*W3.8*H2.4mm,</p> <p>96.0000000KHz, Tolerance: ±30ppm, Load Capacitance (CL): 12.5pF</p> <p>ESR 50 Kohm Max, Operating Temp. Range -40°C ~+85°C</p> <p>Reflow Profile Condition 260 °C Max.</p> <p>Packed in Tape/Reel, 3000pcs/Reel</p> <p>RoHS/RoHS III compliant, RoHS Annex III lead Exemption (Exempt per RoHS EU 2015/863)</p>	
CUSTOMER		
CUSTOMER PART NUMBER		
CROSS PART NUMBER	MA306	
MEMO		

VENDOR APPROVE		
Issued/Checked/Approved		
		
Date: Dec. 23, 2024		

CUSTOMER APPROVE	
Date:	

MAIN FEATURE

- KHz SMD Crystal, Plastic Case L8.0*W3.8*H2.4mm, 4 pads
- Industry Standard
- Reflow Profile Condition 260 °C Max.
- Operating Temperature Range: -40~+85°C
- Available Load Capacitance(CL) Range 6pF~30pF and standard CL
6pF/7pF/9pF/12.5pF
- Low ESR 50 Kohm Max.
- Material Safety Data Sheet (MSDS)
- Offer Quality Alternatives Parts For Major Brand MA306 and more
- Moisture Sensitivity Level (MSL) 1 (Unlimited)
- RoHS/RoHS III compliant, RoHS Annex III lead Exemption (exempt per RoHS
EU 2015/863)



Image shown is a representation only. Exact specifications should be obtained from the product dimension.



MAIN APPLICATION

- Clock Source For Portable
- Mobile Communications And Consumer Devices, Etc.
- Smart Card And Wearable Devices

ELECTRICAL CHARACTERISTICS

- See Page 6 ~Page 9 For Different Part Code
- All Products Parameters are Subject To NextGen Components' Final Confirmation.

HOW TO ORDER

- Please Follow Up Part Code Guide And Indicate Part Code YP96K00000S103 For RFQ/Order.

PART CODE GUIDE

RFQ
[Request For Quotation](#)

CODE	NAME	KEY SPECIFICATION OPTION
YP	Product Index	KHz SMD Crystal, Plastic Case L8.0*W3.8*H2.4mm, 4 pads
96K0	Frequency Range	96K0: 96.0KHz or Custom Frequency Range by Page 7~ Page 9
0000S	Internal Control Code	Special letter A~Z , a~z or digits (1-9)
103	Parameters Code	Special Parameters Code letter A~Z, a~z or Digits (1-9)
XX	Suffix	Blank: N/A XX: Letter A~Z, a~z or digits (0~9) for Special/Custom Parameters

DIMENSION (Unit: mm, Plastic Case L8.0*W3.8*H2.4mm, 4 Pads)

Top View



Side View

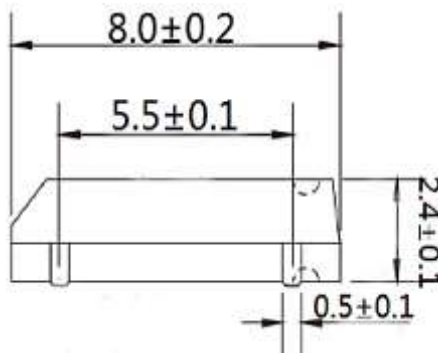

Side View

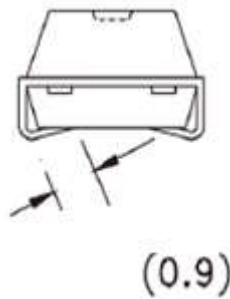

Note: Metal (Crystal inside) may be exposed on the top or bottom of plastic case. That will not be affect performance and reliability of the part in use.

Recommend Pad Layout (unit: mm)

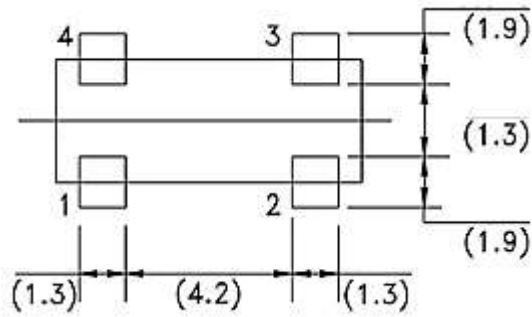

Electrode Arrangement

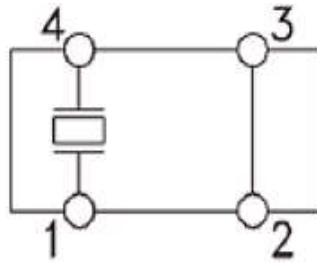

Pin 2 and Pin 3 are not connected to the GND

GENERAL ELECTRICAL PARAMETERS

PARAMETERS	SYMBOL	UNITS	VALUE			CONDITION
			MIN.	TYP.	MAX.	
Frequency Range	F0	KHz	32.000	-	153.60	Customer specified
Frequency Temp. Coefficient	$\Delta f/f_0$	ppm/C ²	-0.034 ± 0.006			
Turnover Temperature	T _m	°C	20	25	30	
Operating Temperature Range	T _{OP}	°C	-40		+85	
Storage Temperature Range	T _{ST}	°C	-55		+125	
Quality Factor	Q				75000	
Shunt Capacitance	C0	pF	0.9	1.35	2.0	
Motional Capacitance	C1	Ff	2.3		3.0	
Insulation Resistance	IR	mΩ	500			DC100V ± 15V
Drive Level	DL	μW			1	
Capacitance Ratio	R			450		
Aging per Year	Δ/f	ppm	±3		±5	@25°C±3°C
Moist are Sensitivity Level	MSL		1			J-STD-033

MAIN ELECTRICAL PARAMETERS - Ta = 25°C

NEXTGEN PART CODE	FREQUENCY RANGE	FREQUENCY TOLERANCE	LOAD CAPACITANCE	OPERATING TEMPERATURE	ESR MAX.
	KHz	ppm	pF	°C	KΩ
YP32K00000S101	32.000	±10	12.5	-40 ~ +85	50
YP32K00000S102	32.000	±20	12.5	-40 ~ +85	50
YP32K00000S103	32.000	±30	12.5	-40 ~ +85	50
YP32K76800S006	32.768	±10	6	-40 ~ +85	60
YP32K76800S601	32.768	±10	6	-40 ~ +85	50
YP32K76800S002	32.768	±20	6	-40 ~ +85	60
YP32K76800S602	32.768	±20	6	-40 ~ +85	50
YP32K76800S603	32.768	±30	6	-40 ~ +85	50
YP32K76800S701	32.768	±10	7	-40 ~ +85	50
YP32K76800S702	32.768	±20	7	-40 ~ +85	50
YP32K76800S703	32.768	±30	7	-40 ~ +85	50
YP32K76800S901	32.768	±10	9	-40 ~ +85	50
YP32K76800S902	32.768	±20	9	-40 ~ +85	50
YP32K76800S903	32.768	±30	9	-40 ~ +85	50
YP32K76800S101	32.768	±10	12.5	-40 ~ +85	50
YP32K76800S102	32.768	±20	12.5	-40 ~ +85	50
YP32K76800S103	32.768	±30	12.5	-40 ~ +85	50
YP32K76800S003	32.768	±30	12.5	-40 ~ +85	60
YP36K00000S101	36.000	±10	12.5	-40 ~ +85	50
YP36K00000S102	36.000	±20	12.5	-40 ~ +85	50

MAIN ELECTRICAL PARAMETERS - Ta = 25°C

NEXTGEN PART CODE	FREQUENCY RANGE	FREQUENCY TOLERANCE	LOAD CAPACITANCE	OPERATING TEMPERATURE	ESR MAX.
	KHz	ppm	pF	°C	KΩ
YP36K00000S103	36.000	±30	12.5	-40 ~ +85	50
YP38K00000S101	38.000	±10	12.5	-40 ~ +85	50
YP38K00000S102	38.000	±20	12.5	-40 ~ +85	50
YP38K00000S103	38.000	±30	12.5	-40 ~ +85	50
YP38K40000S101	38.400	±10	12.5	-40 ~ +85	50
YP38K40000S102	38.400	±20	12.5	-40 ~ +85	50
YP38K40000S103	38.400	±30	12.5	-40 ~ +85	50
YP40K00000S101	40.000	±10	12.5	-40 ~ +85	50
YP40K00000S102	40.000	±20	12.5	-40 ~ +85	50
YP40K00000S103	40.000	±30	12.5	-40 ~ +85	50
YP60K00000S101	60.000	±10	12.5	-40 ~ +85	50
YP60K00000S102	60.000	±20	12.5	-40 ~ +85	50
YP60K00000S103	60.000	±30	12.5	-40 ~ +85	50
YP65K53600S101	65.536	±10	12.5	-40 ~ +85	50
YP65K53600S102	65.536	±20	12.5	-40 ~ +85	50
YP65K53600S103	65.536	±30	12.5	-40 ~ +85	50
YP75K00000S101	75.000	±10	12.5	-40 ~ +85	50
YP75K00000S102	75.000	±20	12.5	-40 ~ +85	50
YP75K00000S103	75.000	±30	12.5	-40 ~ +85	50
YP76K80000S101	76.800	±10	12.5	-40 ~ +85	50

MAIN ELECTRICAL PARAMETERS - Ta = 25°C

NEXTGEN PART CODE	FREQUENCY RANGE	FREQUENCY TOLERANCE	LOAD CAPACITANCE	OPERATING TEMPERATURE	ESR MAX.
	KHz	ppm	pF	°C	KΩ
YP76K80000S102	76.800	±20	12.5	-40 ~ +85	50
YP76K80000S103	76.800	±30	12.5	-40 ~ +85	50
YP77K50000S101	77.500	±10	12.5	-40 ~ +85	50
YP77K50000S102	77.500	±20	12.5	-40 ~ +85	50
YP77K50000S103	77.500	±30	12.5	-40 ~ +85	50
YP77K50300S101	77.503	±10	12.5	-40 ~ +85	50
YP77K50300S102	77.503	±20	12.5	-40 ~ +85	50
YP77K50300S103	77.503	±30	12.5	-40 ~ +85	50
YP96K00000S101	96.000	±10	12.5	-40 ~ +85	50
YP96K00000S102	96.000	±20	12.5	-40 ~ +85	50
YP96K00000S103	96.000	±30	12.5	-40 ~ +85	50
YP100K00000S101	100.00	±10	12.5	-40 ~ +85	50
YP100K00000S102	100.00	±20	12.5	-40 ~ +85	50
YP100K00000S103	100.00	±30	12.5	-40 ~ +85	50
YP153K6000S101	153.60	±10	12.5	-40 ~ +85	50
YP153K6000S102	153.60	±20	12.5	-40 ~ +85	50
YP153K6000S103	153.60	±30	12.5	-40 ~ +85	50
YP153K6000S105	153.60	±50	12.5	-40 ~ +85	50

TEST STANDARD

Equivalent Circuits

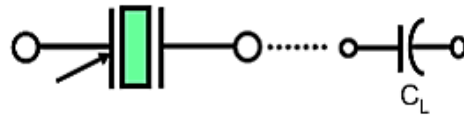

Symbol for crystal unit

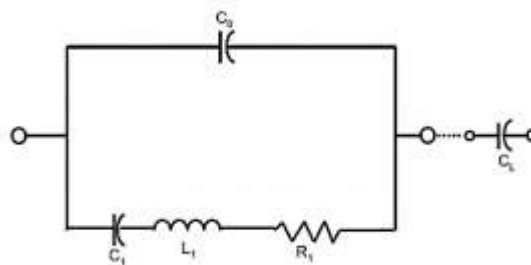

Exemption Rule

1. SMD Tuning Fork Crystal series contain Pb chemical substance where solder material is over limitation. The location see at below drawing, The solder purpose is base connected with chip crystal blank.

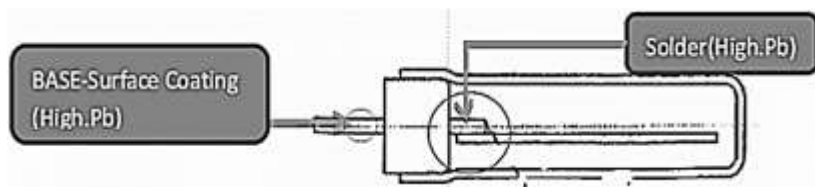

2. Below statement is that exemption rule: Lead in high melting temperature type solders (i.e. lead-based alloys containing 85 % by weight or more lead).(RoHS 6/5 2002/95/EC)

RELIABILITY (Mechanical And Environmental Endurance)

TEST ITEMS	TEST METHOD AND CONDITIONS	REQUIREMENTS
Vibration	<ol style="list-style-type: none"> 1. Vibration Frequency: 10 To 55hz 2. Vibration Amplitude: 1.5mm 3. Cycle Time: 1~2min(10-55-10hz) 4. Direction: X.Y.Z 5. Duration: 2h/Each Direction, total 6Hours 	Frequency Change: ±10ppm Max. Resistance Change: ± 15% Rr Max
Drop	3 Times Free Fall From 75cm Height table to 3cm thickness hard wood board, After 30 minutes, the relative change value of frequency was measured.	Frequency Change: ±10ppm Max. Resistance Change: ± 15% Rr Max.
Leakage	Placed in a helium pressurized tank and filled with helium at a pressure of 0.5-0.6mpa for 1 hour then tested with a helium mass spectrometry leak detector.	Leakage:1x10 ⁻⁸ mbar.L/S Max.
Solder ability	Dip in flux 3-5 seconds Temperature: 260°C ± 5°C	Solder adhesion is good, solder adhesion more than 95%
High Temp Storage	Temperature: 125°C ± 5°C for 72 H, and the relative change in frequency was measured after 1-2 hours at room temperature	Frequency Change: ± 10ppm Max. Resistance Change: ± 15% Rr Max.
Low Temp Storage	Temperature: -45°C ± 5°C for 72 H, and the relative change in frequency was measured after 1-2 hours at room temperature	Frequency Change: ± 10ppm Max. Resistance Change: ± 15% Rr Max.

SUGGESTED REFLOW PROFILE (For Reference No. JEDEC J-STD-020D)



PROFILE FEATURE		PB-FREE ASSEMBLY
Average Ramp-up Rate (Ts Max to Tp)		3°C/second Max
Preheat	Temperature Min (Ts Min.)	150°C
	Temperature Max (Ts Max.)	200°C
	Time (ts Min. to ts Max.)	60 ~ 120 seconds
Time maintained above	Temperature (TL)	217°C
	Time (tL)	60 ~ 150 seconds
Peak/Classification Temperature (Tp)		260 +/-5°C
Time within 5°C of actual Peak Temperature (tp)		20 ~ 40 seconds
Ramp-down rate		6 °C /Second Max.
Time 25 °C to Peak Temperature		8 minutes Max.
Suggest reflow times		3 Times Max.

REEL AND TAPE DIMENSION (Unit: mm)

All Devices are packed in accordance with EIA standard RS-481-2 and specifications, 3000pcs/Reel

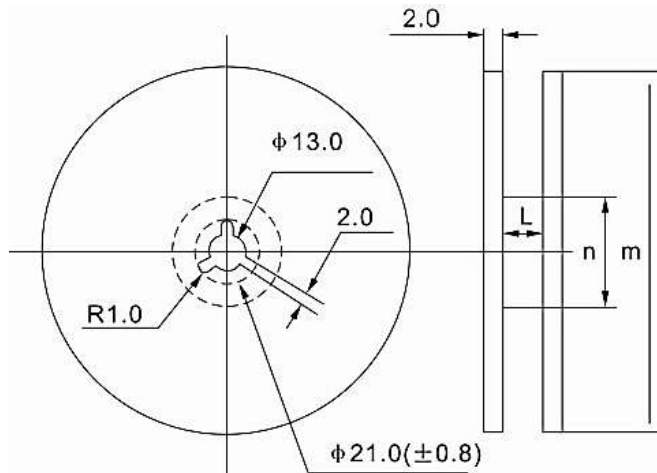
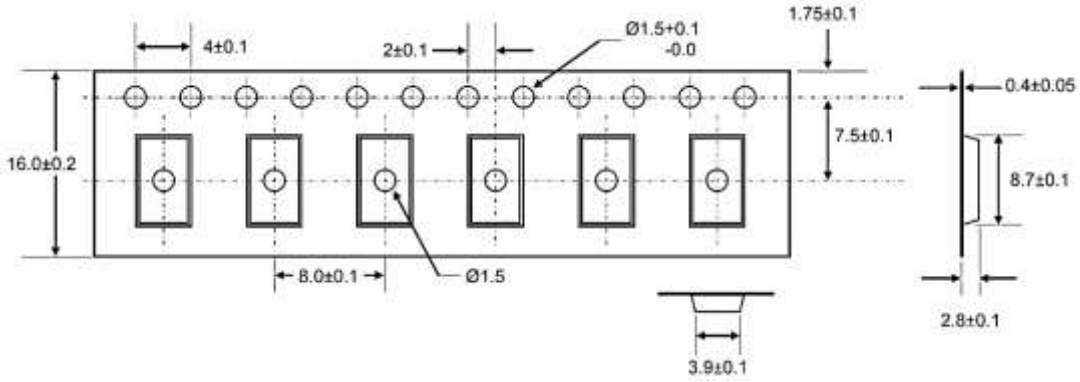

SYMBOL	Φm	Φn	L	CARRIER TAPE SIZE
Dimension	330±3	80 Min.	17.5	16

CAUTION

In Order To Maintain Quality. Without Change In Characteristics Of The crystal Units. Please Follow Below Recommendation

Shock

All Crystal Units Have A Thin Crystal Blanks Within If It Is Dropped Above The Recommended Dropping Height (500mm) The Specific Characteristics And Appearance Can Be Changed Please Pay Special Attention To External Shock

Environmental

1. Crystal Units' Frequency Can Be Changed Due To Surrounding Temperature If It Is Stored Next To A High Temperature Heater (Above+85°C) Or Below 40°C. And A Strong Light Source For Long Period Of Time. The Electrical Characteristics Can Be Changed It Is Suggested That These Environment Be Avoided
2. If The Unit Is Placed In A Humid Environment. Lead Terminal Can Be Damaged: Therefore. Do Not Store The Crystal Units In A Humid Environment
3. Crystal unit Has Vibrating Characteristics If It Is Placed Where Vibration Exists The Operating Characteristics Can Be Altered; Therefore This Environment Should Be Avoided

Leads

1. After Soldering Crystal Units Into A PCB Impacting The Unit From The top, bottom Left Or Right Side Of The Unit Can Shatter The Glass Portion Of The Base Rendering The Unit Useless

Assembly Method

1. Correct Ultrasonic Frequency For Cleaning Should Be Less Than 20khz
2. Soldering Should Be Done Using IEC 61760-1 OR Pb-free Products

Storage

If The Crystal Units Are Stored In Humid Or Salty Environment Appearance Can Be Changed And Solderability Can Deteriorate; Therefore avoid Storing In Such Environment Do Not Store The Crystal Unit More Than 3 Months

IMPORTANT NOTES AND DISCLAIMER

1. **ROHS COMPLIANCE:** The levels of RoHS restricted materials in this product are below the maximum concentration values (also referred to as the threshold limits) permitted for such substances, or are used in an exempted application, in accordance with EU RoHS Directive (EU) 2015/863 EC (RoHS3). RoHS Test Report for this product can be obtained at Download Center.
2. **REACH COMPLIANCE:** REACH substances of high concern (SVHCs) information is available for this product. Since the European Chemical Agency (ECHA) has published notice of their intent to frequently revise the SVHC listing for the foreseeable future, REACH Test Report for this product can be obtained at Download Center.
3. All Product parametric performance is indicated in the Electrical Characteristics for the listed herein test conditions, unless otherwise noted. Product performance may not be indicated by the Electrical Characteristics if operated under different conditions.
4. NextGen Component, Inc (*NextGen*) reserves the right to make changes to this document and its products and specifications at any time without notice. Customers should obtain and confirm the latest product information and specifications before final design, purchase or use.
5. *NextGen* makes no warranty, representation or guarantee regarding the suitability of its products for any particular purpose, not does *NextGen* assume any liability for application assistance or customer product design.
6. *NextGen* does not warrant or accept any liability with products which are purchased or used for any unintended or unauthorized application. No license is granted by implication or otherwise under any intellectual property rights of NextGen.
7. *NextGen* products are not authorized for use as critical components in life support devices or systems without express written approval by *NextGen*.
8. *NextGen* requires that customers first obtain an RMA (Returned Merchandise Authorization) number prior to returning any products. Returns must be made within 30 days of the date of invoice, be in the original packaging, unused and like-new condition. At the time of quoting or purchasing, a product may say that it is Non-Cancelable/ Non-Returnable (NCNR). These products are not returnable and not refundable.