



SPECIFICATION SHEET NO.	S0102 - XP9M216000S412	
ORIGINAL MFG/PART NO.	TGS Crystals/CMG632 9M216A30-12-30-40-150TLH	
NEXTGEN PART CODE	XP9M216000S412	Indicate This Code For RFQ/Order
DATE	Jan. 2, 2025	
REVISION	A1	Updated With Most Recent Data
DESCRIPTION AND MAIN PARAMETRICS	<p>MHz SMD Crystal Glass seal, Ceramic Cover, 6035 Type, 2 pads, XP Series Dimension L6.0*W3.5*H1.2mm 9.216MHz, Tolerance ± 30ppm, Load Capacitor 12pF Frequency stability ± 30ppm; Operating Temp. Range $-40^{\circ}\text{C} \sim +85^{\circ}\text{C}$, ESR 150 ohm Max, Reflow Profile Condition 260 $^{\circ}\text{C}$ Max. Package in Tape/Reel, 1000pcs/Reel RoHS/RoHS III compliant, RoHS Annex III lead Exemption (exempt per RoHS EU 2015/863)</p>	
CUSTOMER		
CUSTOMER PART NUMBER		
CROSS REF. PART NUMBER		
MEMO		

VENDOR APPROVE		
Issued/Checked/Approved		 
Effective Date: Jan. 2, 2025		

CUSTOMER APPROVE	
Date:	

MAIN FEATURE

- MHz SMD Crystal, 6035 Type, L6.0*W3.5*H1.2mm, 2 pads
- Glass seal, Ceramic Cover
- Low cost, High precision, High frequency stability.
- Low Profile and Short Lead time
- RoHS/RoHS III Compliant, RoHS Annex III Lead Exemption
(exempt per RoHS EU 2015/863)
- Moisture Sensitivity Level (MSL) Level 1
- Excellent Aging and Wide Frequency Range



Image shown is a representation only. Exact specifications should be obtained from the product dimension.



APPLICATION

- Bluetooth, wireless communication set
- Communication Electronics

ELECTRICAL CHARACTERISTICS

- See Page 5 ~Page 13 For Different Part Code And Rated Voltage.
- All Products Parameters are Subject To NextGen Components' Final Confirmation.

HOW TO ORDER

- Please Follow Up Part Code Guide And Indicate NextGen Part Code XP9M216000S412 For RFQ and Order.

PART CODE GUIDE

RFQ
[Request For Quotation](#)

CODE	NAME	KEY SPECIFICATION OPTION
XP	Series Code	MHz SMD Crystal Glass seal, Ceramic Cover, 6035 Type, 2 pads
9M216	Frequency Range Code	9M216: 9.216MHz or Custom Frequency Range by Page 6~ Page 13
000S	Internal Control Code	Letter A~Z, a~z or digits (0~9)
412	Parameters code	Special Parameters Code Letter A~Z, a~z or digits (1-9)
()	Special/Custom Parameters Code	Blank: N/A XX: Letter A~Z, a~z or digits (0~9) for Special/Custom Parameters

DIMENSION (Unit: Inch/mm)

Top View

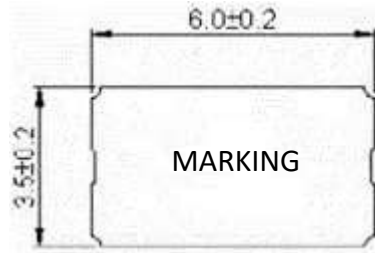

Side View

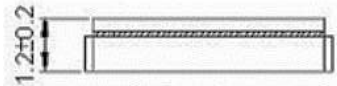

Bottom View

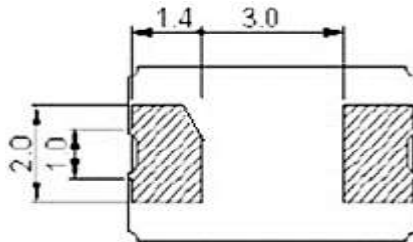

Connection

#1 Crystal #2 Crystal

or

Alternative Case

Bottom View

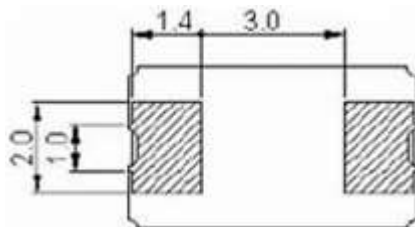

GENERAL SPECIFICATION

PARAMETER	SYMBOL	VALUE			UNIT	CONDITION
		MIN.	TYPE	MAX.		
Frequency Range	F0	8.0000	-	54.000	MHz	Customer specified
Mode of Vibration Code		Fundamental				Optional: 3rd OT Or 5th OT
Frequency Tolerance	$\Delta F/F0$	± 10	± 30	± 50	ppm	at 25°C ± 3 °C
Load Capacitance	CL	4	18	Series	pF	Customer specified
Frequency Stability	Tc	± 10	± 30	± 50	ppm	Customer specified
Operating Temp. Range	TOPR	-40	-	+85	°C	Standard
Storage Temp. Range	TSTG	-55	-	+125	°C	
Equivalent Series Resistance	ESR	See Table 1			Ω	Customer specified
Drive Level	DL	-	100	200	μW	
Insulation Resistance	IR	500	-		m Ω	At 100VDC
Shunt Capacitance	C0	-	-	5.0	pF	
Aging per year	Fa	-3	-	+3	ppm	1st Year

Table 1

FREQUENCY RANGE	MODE OF VIBRATION	ESR (Ω) MAX
8.0000MHz \leq F0 <10.000MHz	Fundamental	150
10.000MHz \leq F0 <20.000MHz	Fundamental	60
20.000MHz \leq F0 <30.000MHz	Fundamental	40
30.000MHz \leq F0 <54.000MHz	Fundamental	30

ELECTRICAL PARAMETERS – FOR DIFFERENT PART CODE- Ta = 25°C

PART CODE	FREQUENCY RANGE	FREQUENCY TOLERANCE	LOAD CAPACITANCE	FREQUENCY STABILITY	OPERATING TEMPE. RANGE	EQUIVALENT SERIES RESISTANCE
	MHz	ppm	pF	ppm	°C	Ω Max.
XP8M000000S408	8.00000	±30	8	±30	-40 ~+85	150
XP8M000000S410	8.00000	±30	10	±30	-40 ~+85	150
XP8M000000S412	8.00000	±30	12	±30	-40 ~+85	150
XP8M000000S416	8.00000	±30	16	±30	-40 ~+85	150
XP8M000000S418	8.00000	±30	18	±30	-40 ~+85	150
XP8M000000S420	8.00000	±30	20	±30	-40 ~+85	150
XP8M192000S408	8.19200	±30	8	±30	-40 ~+85	150
XP8M192000S410	8.19200	±30	10	±30	-40 ~+85	150
XP8M192000S412	8.19200	±30	12	±30	-40 ~+85	150
XP8M192000S416	8.19200	±30	16	±30	-40 ~+85	150
XP8M192000S418	8.19200	±30	18	±30	-40 ~+85	150
XP8M192000S420	8.19200	±30	20	±30	-40 ~+85	150
XP9M216000S408	9.21600	±30	8	±30	-40 ~+85	150
XP9M216000S410	9.21600	±30	10	±30	-40 ~+85	150
XP9M216000S412	9.21600	±30	12	±30	-40 ~+85	150
XP9M216000S416	9.21600	±30	16	±30	-40 ~+85	150
XP9M216000S418	9.21600	±30	18	±30	-40 ~+85	150
XP9M216000S420	9.21600	±30	20	±30	-40 ~+85	150
XP9M830400S408	9.83040	±30	8	±30	-40 ~+85	150
XP9M830400S410	9.83040	±30	10	±30	-40 ~+85	150

ELECTRICAL PARAMETERS – FOR DIFFERENT PART CODE- Ta = 25°C

PART CODE	FREQUENCY RANGE	FREQUENCY TOLERANCE	LOAD CAPACITANCE	FREQUENCY STABILITY	OPERATING TEMPE. RANGE	EQUIVALENT SERIES RESISTANCE
	MHz	ppm	pF	ppm	°C	Ω Max.
XP9M830400S412	9.83040	±30	12	±30	-40 ~+85	150
XP9M830400S416	9.83040	±30	16	±30	-40 ~+85	150
XP9M830400S418	9.83040	±30	18	±30	-40 ~+85	150
XP9M830400S420	9.83040	±30	20	±30	-40 ~+85	150
XP10M00000S408	10.00000	±30	8	±30	-40 ~+85	60
XP10M00000S410	10.00000	±30	10	±30	-40 ~+85	60
XP10M00000S412	10.00000	±30	12	±30	-40 ~+85	60
XP10M00000S416	10.00000	±30	16	±30	-40 ~+85	60
XP10M00000S418	10.00000	±30	18	±30	-40 ~+85	60
XP10M00000S420	10.00000	±30	20	±30	-40 ~+85	60
XP11M05920S408	11.05920	±30	8	±30	-40 ~+85	60
XP11M05920S410	11.05920	±30	10	±30	-40 ~+85	60
XP11M05920S412	11.05920	±30	12	±30	-40 ~+85	60
XP11M05920S416	11.05920	±30	16	±30	-40 ~+85	60
XP11M05920S418	11.05920	±30	18	±30	-40 ~+85	60
XP11M05920S420	11.05920	±30	20	±30	-40 ~+85	60
XP12M00000S408	12.00000	±30	8	±30	-40 ~+85	60
XP12M00000S410	12.00000	±30	10	±30	-40 ~+85	60
XP12M00000S412	12.00000	±30	12	±30	-40 ~+85	60
XP12M00000S416	12.00000	±30	16	±30	-40 ~+85	60

ELECTRICAL PARAMETERS – FOR DIFFERENT PART CODE- Ta = 25°C

PART CODE	FREQUENCY RANGE	FREQUENCY TOLERANCE	LOAD CAPACITANCE	FREQUENCY STABILITY	OPERATING TEMPE. RANGE	EQUIVALENT SERIES RESISTANCE
	MHz	ppm	pF	ppm	°C	Ω Max.
XP12M00000S418	12.00000	±20	18	±30	-40 ~+85	60
XP12M00000S420	12.00000	±30	20	±30	-40 ~+85	60
XP12M000S32418	12.00000	±30	18	±20	-40 ~+85	60
XP12M28800S408	12.28800	±30	8	±30	-40 ~+85	60
XP12M28800S410	12.28800	±30	10	±30	-40 ~+85	60
XP12M28800S412	12.28800	±30	12	±30	-40 ~+85	60
XP12M28800S416	12.28800	±30	16	±30	-40 ~+85	60
XP12M28800S418	12.28800	±30	18	±30	-40 ~+85	60
XP12M28800S420	12.28800	±30	20	±30	-40 ~+85	60
XP13M56000S408	13.56000	±30	8	±30	-40 ~+85	60
XP13M56000S410	13.56000	±30	10	±50	-40 ~+85	60
XP13M56000S412	13.56000	±30	12	±30	-40 ~+85	60
XP13M56000S416	13.56000	±30	16	±30	-40 ~+85	60
XP13M56000S418	13.56000	±30	18	±50	-40 ~+85	60
XP13M56000S420	13.56000	±30	20	±30	-40 ~+85	60
XP14M31818S408	14.31818	±30	8	±30	-40 ~+85	60
XP14M31818S410	14.31818	±30	10	±30	-40 ~+85	60
XP14M31818S412	14.31818	±30	12	±30	-40 ~+85	60
XP14M31818S416	14.31818	±30	16	±30	-40 ~+85	60
XP14M31818S418	14.31818	±30	18	±30	-40 ~+85	60

ELECTRICAL PARAMETERS – FOR DIFFERENT PART CODE- Ta = 25°C

PART CODE	FREQUENCY RANGE	FREQUENCY TOLERANCE	LOAD CAPACITANCE	FREQUENCY STABILITY	OPERATING TEMPE. RANGE	EQUIVALENT SERIES RESISTANCE
	MHz	ppm	pF	ppm	°C	Ω Max.
XP14M31818S420	14.31818	±30	20	±30	-40 ~+85	60
XP14M74560S408	14.74560	±30	8	±30	-40 ~+85	60
XP14M74560S410	14.74560	±30	10	±30	-40 ~+85	60
XP14M74560S412	14.74560	±30	12	±30	-40 ~+85	60
XP14M74560S416	14.74560	±30	16	±30	-40 ~+85	60
XP14M74560S418	14.74560	±30	18	±30	-40 ~+85	60
XP14M74560S420	14.74560	±30	20	±30	-40 ~+85	60
XP16M00000S408	16.00000	±30	8	±30	-40 ~+85	60
XP16M00000S410	16.00000	±30	10	±30	-40 ~+85	60
XP16M00000S412	16.00000	±30	12	±30	-40 ~+85	60
XP16M00000S416	16.00000	±30	16	±30	-40 ~+85	60
XP16M00000S418	16.00000	±30	18	±30	-40 ~+85	60
XP16M00000S420	16.00000	±30	20	±30	-40 ~+85	60
XP18M43200S408	18.43200	±30	8	±30	-40 ~+85	60
XP18M43200S410	18.43200	±30	10	±30	-40 ~+85	60
XP18M43200S412	18.43200	±30	12	±30	-40 ~+85	60
XP18M43200S416	18.43200	±30	16	±30	-40 ~+85	60
XP18M43200S418	18.43200	±30	18	±30	-40 ~+85	60
XP18M43200S420	18.43200	±30	20	±30	-40 ~+85	60
XP19M66080S408	19.66080	±30	8	±30	-40 ~+85	60

ELECTRICAL PARAMETERS – FOR DIFFERENT PART CODE- Ta = 25°C

PART CODE	FREQUENCY RANGE	FREQUENCY TOLERANCE	LOAD CAPACITANCE	FREQUENCY STABILITY	OPERATING TEMPE. RANGE	EQUIVALENT SERIES RESISTANCE
	MHz	ppm	pF	ppm	°C	Ω Max.
XP19M66080S410	19.66080	±30	10	±30	-40 ~+85	60
XP19M66080S412	19.66080	±30	12	±30	-40 ~+85	60
XP19M66080S416	19.66080	±30	16	±30	-40 ~+85	60
XP19M66080S418	19.66080	±30	18	±30	-40 ~+85	60
XP19M66080S420	19.66080	±30	20	±30	-40 ~+85	60
XP20M00000S408	20.00000	±30	8	±30	-40 ~+85	40
XP20M00000S410	20.00000	±30	10	±30	-40 ~+85	40
XP20M00000S412	20.00000	±30	12	±30	-40 ~+85	40
XP20M00000S416	20.00000	±30	16	±30	-40 ~+85	40
XP20M00000S418	20.00000	±30	18	±30	-40 ~+85	40
XP20M00000S420	20.00000	±30	20	±30	-40 ~+85	40
XP22M11840S408	22.11840	±30	8	±30	-40 ~+85	40
XP22M11840S410	22.11840	±30	10	±30	-40 ~+85	40
XP22M11840S412	22.11840	±30	12	±30	-40 ~+85	40
XP22M11840S416	22.11840	±30	16	±30	-40 ~+85	40
XP22M11840S418	22.11840	±30	18	±30	-40 ~+85	40
XP22M11840S420	22.11840	±30	20	±30	-40 ~+85	40
XP24M00000S408	24.00000	±30	8	±30	-40 ~+85	40
XP24M00000S410	24.00000	±30	10	±30	-40 ~+85	40
XP24M00000S412	24.00000	±30	12	±30	-40 ~+85	40

ELECTRICAL PARAMETERS – FOR DIFFERENT PART CODE- Ta = 25°C

PART CODE	FREQUENCY RANGE	FREQUENCY TOLERANCE	LOAD CAPACITANCE	FREQUENCY STABILITY	OPERATING TEMPE. RANGE	EQUIVALENT SERIES RESISTANCE
	MHz	ppm	pF	ppm	°C	Ω Max.
XP24M00000S416	24.00000	±30	16	±30	-40 ~+85	40
XP24M00000S418	24.00000	±30	18	±30	-40 ~+85	40
XP24M00000S420	24.00000	±30	20	±30	-40 ~+85	40
XP24M57600S408	24.57600	±30	8	±30	-40 ~+85	40
XP24M57600S410	24.57600	±30	10	±30	-40 ~+85	40
XP24M57600S412	24.57600	±30	12	±30	-40 ~+85	40
XP24M57600S416	24.57600	±30	16	±30	-40 ~+85	40
XP24M57600S418	24.57600	±30	18	±30	-40 ~+85	40
XP24M57600S420	24.57600	±30	20	±30	-40 ~+85	40
XP25M00000S408	25.00000	±30	8	±30	-40 ~+85	40
XP25M00000S410	25.00000	±30	10	±30	-40 ~+85	40
XP25M00000S412	25.00000	±30	12	±30	-40 ~+85	40
XP25M00000S416	25.00000	±30	16	±30	-40 ~+85	40
XP25M00000S418	25.00000	±30	18	±30	-40 ~+85	40
XP25M00000S420	25.00000	±30	20	±30	-40 ~+85	40
XP27M00000S408	27.00000	±30	8	±30	-40 ~+85	40
XP27M00000S410	27.00000	±30	10	±30	-40 ~+85	40
XP27M00000S412	27.00000	±30	12	±30	-40 ~+85	40
XP27M00000S416	27.00000	±30	16	±30	-40 ~+85	40
XP27M00000S418	27.00000	±30	18	±30	-40 ~+85	40

ELECTRICAL PARAMETERS – FOR DIFFERENT PART CODE- Ta = 25°C

PART CODE	FREQUENCY RANGE	FREQUENCY TOLERANCE	LOAD CAPACITANCE	FREQUENCY STABILITY	OPERATING TEMPE. RANGE	EQUIVALENT SERIES RESISTANCE
	MHz	ppm	pF	ppm	°C	Ω Max.
XP27M00000S420	27.00000	±30	20	±30	-40 ~+85	40
XP28M63636S408	28.63636	±30	8	±30	-40 ~+85	40
XP28M63636S410	28.63636	±30	10	±30	-40 ~+85	40
XP28M63636S412	28.63636	±30	12	±30	-40 ~+85	40
XP28M63636S416	28.63636	±30	16	±30	-40 ~+85	40
XP28M63636S418	28.63636	±30	18	±30	-40 ~+85	40
XP28M63636S420	28.63636	±30	20	±30	-40 ~+85	40
XP30M00000S408	30.00000	±30	8	±30	-40 ~+85	30
XP30M00000S410	30.00000	±30	10	±30	-40 ~+85	30
XP30M00000S412	30.00000	±30	12	±30	-40 ~+85	30
XP30M00000S416	30.00000	±30	16	±30	-40 ~+85	30
XP30M00000S418	30.00000	±30	18	±30	-40 ~+85	30
XP30M00000S420	30.00000	±30	20	±30	-40 ~+85	30
XP32M00000S408	32.00000	±30	8	±30	-40 ~+85	30
XP32M00000S410	32.00000	±30	10	±30	-40 ~+85	30
XP32M00000S412	32.00000	±30	12	±30	-40 ~+85	30
XP32M00000S416	32.00000	±30	16	±30	-40 ~+85	30
XP32M00000S418	32.00000	±30	18	±30	-40 ~+85	30
XP32M00000S420	32.00000	±30	20	±30	-40 ~+85	30
XP40M00000S408	40.00000	±30	8	±30	-40 ~+85	30

ELECTRICAL PARAMETERS – FOR DIFFERENT PART CODE- Ta = 25°C

PART CODE	FREQUENCY RANGE	FREQUENCY TOLERANCE	LOAD CAPACITANCE	FREQUENCY STABILITY	OPERATING TEMPE. RANGE	EQUIVALENT SERIES RESISTANCE
	MHz	ppm	pF	ppm	°C	Ω Max.
XP40M00000S410	40.00000	±30	10	±30	-40 ~+85	30
XP40M00000S412	40.00000	±30	12	±30	-40 ~+85	30
XP40M00000S416	40.00000	±30	16	±30	-40 ~+85	30
XP40M00000S418	40.00000	±30	18	±30	-40 ~+85	30
XP40M00000S420	40.00000	±30	20	±30	-40 ~+85	30
XP48M00000S408	48.00000	±30	8	±30	-40 ~+85	30
XP48M00000S410	48.00000	±30	10	±30	-40 ~+85	30
XP48M00000S412	48.00000	±30	12	±30	-40 ~+85	30
XP48M00000S416	48.00000	±30	16	±30	-40 ~+85	30
XP48M00000S418	48.00000	±30	18	±30	-40 ~+85	30
XP48M00000S420	48.00000	±30	20	±30	-40 ~+85	30
XP50M00000S408	50.00000	±30	8	±30	-40 ~+85	30
XP50M00000S410	50.00000	±30	10	±30	-40 ~+85	30
XP50M00000S412	50.00000	±30	12	±30	-40 ~+85	30
XP50M00000S416	50.00000	±30	16	±30	-40 ~+85	30
XP50M00000S418	50.00000	±30	18	±30	-40 ~+85	30
XP50M00000S420	50.00000	±30	20	±30	-40 ~+85	30

RELIABILITY (MECHANICAL AND ENVIRONMENTAL ENDURANCE)

TEST ITEMS	TEST METHOD AND CONDITIONS	REQUIREMENTS
High Temperature High Humidity Storage	Temperature: 85°C±3°C Relative Humidity:85%RH Time: 96 Hours	JIS C5023
High Temperature Storage	Temperature: 125°C±3°C Time: 96 Hours.	MIL-STD-883E Method 1005.8
Low Temperature Storage	Temperature: -40°C±3°C Time: 96 Hours.	MIL-STD-883E Method 1013
Thermal Shock	Temperature 1: -55°C±5°C Temperature 2: 85°C±5 °C Temperature change between T1 and T2 5 min 10cycles maintain T1 and T2 for 30 minutes each cycle	MIL-STD-202F Method 107 Condition A
Resistance to Solder Heat	Solder Temperature: 260°C±5°C Time: 10±1 Seconds	MIL-STD-202F Method 210E
Solderability	The solder pot temperature is 245±5°C , dwell time 5±0.5sec	J-STD-002B
Drop Test	3 Times Free Fall from 50cm height table to 3cm thickness hard wood board	J-STD-002B
Mechanical Shock	Half sine wave,1000 G 3 Times for all 3 directions(X,Y Z)	MIL STD 202F Method 213B
Vibration	Frequency Range: 10Hz ~ 55Hz Amplitude: 0.75mm 2 Hours in each direction, total 6 Hours	MIL-STD-883E Method 2007.3
Leakage Test	Take measurements with a helium Leakage detector Leakage Rate≤1×10 ⁻³ Pa cm ³ /s	MIL-STD-883E

SUGGESTED REFLOW PROFILE (For Reference Only)



PROFILE FEATURE		PB-FREE ASSEMBLY
Average Ramp-up Rate (Ts Max to Tp)		3°C/second Max
Preheat	Temperature Min (Ts Min.)	125°C
	Temperature Max (Ts Max.)	200°C
	Time (ts Min. to ts Max.)	60 ~ 180 seconds
Time maintained above	Temperature (Tl)	217°C
	Time (tl)	60 ~ 150 seconds
Peak/Classification Temperature (Tp)		260 °C
Time within 5°C of actual Peak Temperature (tp)		20 ~ 40 seconds
Ramp-down rate		6 °C /Second Max.
Time 25 °C to Peak Temperature		8 minutes Max.
Suggest reflow times		3 Times Max.

TAPE AND REEL (1000pcs/Reel, Unit: mm)

All Devices are packed in accordance with EIA standard RS-481-2 and specifications., 1000pcs/Reel

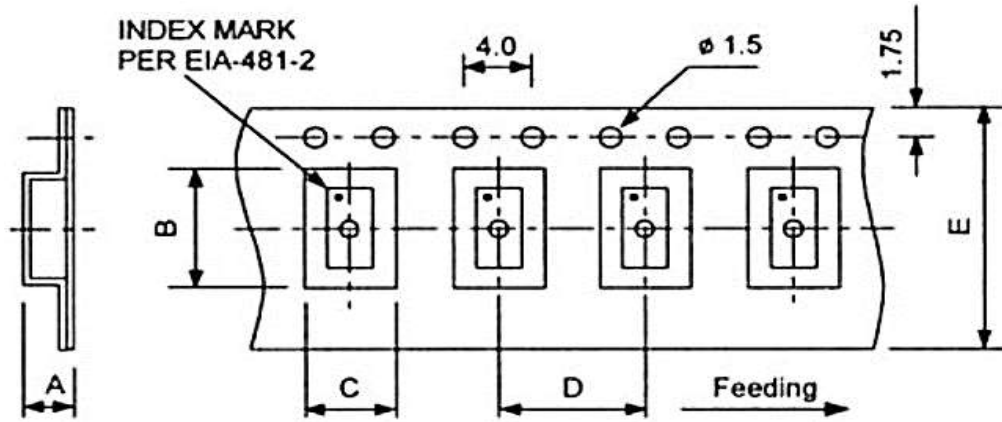

ITEM	DIMENSION
A	1.70
B	5.45
C	3.65
D	8.00
E	12.0

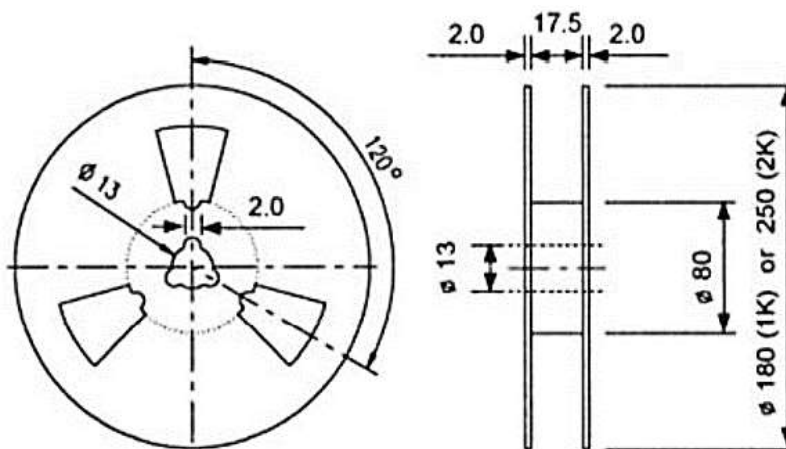

IMPORTANT NOTES AND DISCLAIMER

1. **ROHS COMPLIANCE:** The levels of RoHS restricted materials in this product are below the maximum concentration values (also referred to as the threshold limits) permitted for such substances, or are used in an exempted application, in accordance with EU RoHS Directive (EU) 2015/863 EC (RoHS3). RoHS Test Report for this product can be obtained at Download Center.
2. **REACH COMPLIANCE:** REACH substances of high concern (SVHCs) information is available for this product. Since the European Chemical Agency (ECHA) has published notice of their intent to frequently revise the SVHC listing for the foreseeable future, REACH Test Report for this product can be obtained at Download Center.
3. All Product parametric performance is indicated in the Electrical Characteristics for the listed herein test conditions, unless otherwise noted. Product performance may not be indicated by the Electrical Characteristics if operated under different conditions.
4. NextGen Component, Inc (*NextGen*) reserves the right to make changes to this document and its products and specifications at any time without notice. Customers should obtain and confirm the latest product information and specifications before final design, purchase or use.
5. *NextGen* makes no warranty, representation or guarantee regarding the suitability of its products for any particular purpose, not does *NextGen* assume any liability for application assistance or customer product design.
6. *NextGen* does not warrant or accept any liability with products which are purchased or used for any unintended or unauthorized application. No license is granted by implication or otherwise under any intellectual property rights of NextGen.
7. *NextGen* products are not authorized for use as critical components in life support devices or systems without express written approval by *NextGen*.
8. *NextGen* requires that customers first obtain an RMA (Returned Merchandise Authorization) number prior to returning any products. Returns must be made within 30 days of the date of invoice, be in the original packaging, unused and like-new condition. At the time of quoting or purchasing, a product may say that it is Non-Cancelable/ Non-Returnable (NCNR). These products are not returnable and not refundable.