



SPECIFICATION SHEET NO.	S0112 - YQ27M00000S430	
ORIGINAL MFG/PART NO.	TGS Crystals/CCME 27M0A30-30-50-40-30TLH/PMX308/AMR2700003004F6	
NEXTGEN PART CODE	YQ27M00000S430	Indicate This Code For RFQ/Order
DATE	Jan. 12, 2025	
REVISION	A1	Updated With Most Recent Data
DESCRIPTION AND MAIN PARAMETRICS	<p>MHz SMD Crystal 4 pads, YQ series, Glass seal, Plastic Case, Dimension L12.5*W4.6*H3.7mm 27.000MHz, Tolerance ± 30ppm, Load Capacitor 30pF Frequency stability ± 50ppm; Operating Temp. Range $-40^{\circ}\text{C} \sim +85^{\circ}\text{C}$, ESR 30 ohm Max, Reflow Profile Condition 260 $^{\circ}\text{C}$ Max. Package in Tape/Reel, 1000pcs/Reel RoHS/RoHS III compliant, RoHS Annex III lead Exemption (exempt per RoHS EU 2015/863)</p>	
CUSTOMER		
CUSTOMER PART NUMBER		
CROSS REF. PART NUMBER	EPSON MA406 & MA506	
MEMO		

VENDOR APPROVE		
Issued/Checked/Approved		
		
Effective Date: Jan. 12, 2025		

CUSTOMER APPROVE	
Date:	

MAIN FEATURE

- MHz SMD Crystal L12.5*W4.6*H3.7mm 4 Pads
- Plastic case, Glass seal
- Low Profile and Short Lead time
- RoHS/RoHS III Compliant, RoHS Annex III Lead Exemption
(exempt per RoHS EU 2015/863)
- Moisture Sensitivity Level (MSL) Level 1
- Excellent Aging and Wide Frequency Range
- 4 Pad Fit EPSON MA406 & MA506 Footprint Surface Mount



Image shown is a representation only. Exact specifications should be obtained from the product dimension.



APPLICATION

- Microcontroller Systems, Microprocessors, Communication Interfaces
- Digital Signal Processors (DSPs), Test And Measurement Equipment

ELECTRICAL CHARACTERISTICS

- See Page 6 ~Page 12 For Different Part Code.
- All Products Parameters are Subject To NextGen Components' Final Confirmation.

HOW TO ORDER

- Please Follow Up Part Code Guide And Indicate NextGen Part Code YQ27M00000S430 For RFQ and Order.

PART CODE GUIDE

RFQ
[Request For Quotation](#)

CODE	NAME	KEY SPECIFICATION OPTION
YQ	Series Code	MHz SMD Crystal L12.5*W4.6*H3.7mm 4 Pads
27M0	Frequency Range Code	27M0: 27.0MHz or Custom Frequency Range by Page 6~ Page 12
0000S	Internal Control Code	Letter A~Z, a~z or digits (0~9)
430	Parameters code	Special Parameters Code Letter A~Z, a~z or digits (1-9)
XX	Special/Custom Parameters Code	Blank: N/A XX: Letter A~Z, a~z or digits (0~9) for Special/Custom Parameters

DIMENSION (Unit: Inch/mm)

Top View

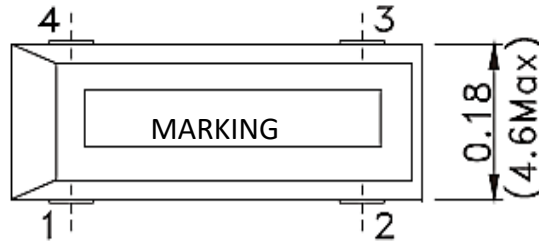

Side View

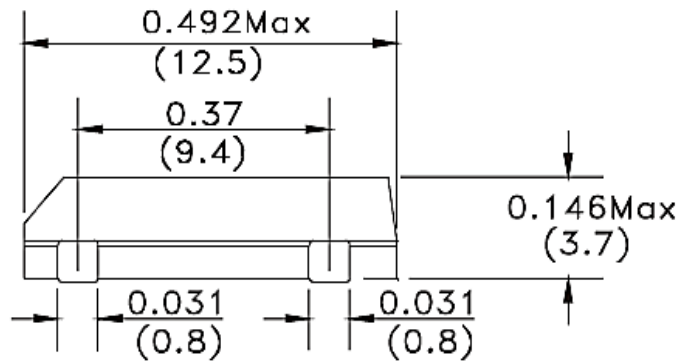

Side View

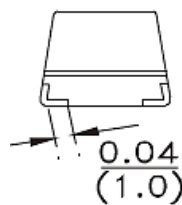

Note: Metal (Crystal inside) may be exposed on the top or bottom of plastic case. That will not be affect performance and reliability of the part in question

Electrode Arrangement

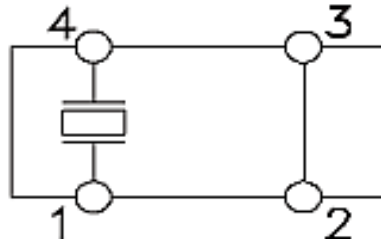

Connection: 1# Crystal; 2# Ground; 3# Ground; 4# Crystal

Solder Pattern (Unit: inch/mm)

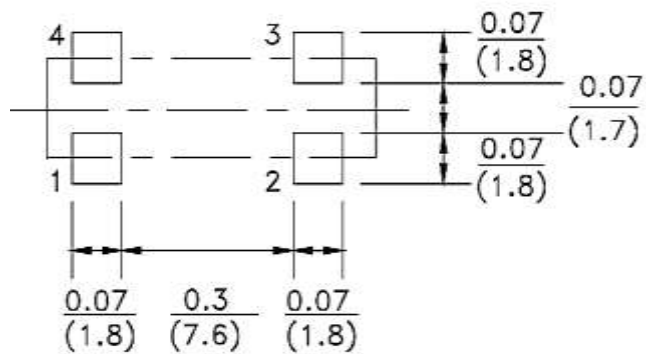

GENERAL SPECIFICATION

PARAMETER	SYMBOL	VALUE			UNIT	CONDITION
		MIN.	TYPE	MAX.		
Frequency Range	F0	7.3728	-	90.000	MHz	Customer specified
Mode of Vibration Code		Fundamental				Optional: 3rd OT Or 5th OT
Frequency Tolerance	$\Delta F/F0$	± 20	± 30	± 50	ppm	at 25°C ± 3 °C
Load Capacitance	CL	6	18	Series	pF	Customer specified
Frequency Stability	Tc	± 30	-	± 50	ppm	Customer specified
Operating Temp. Range	TOPR	-40	-	+85	°C	Standard
Storage Temp. Range	TSTG	-55	-	+125	°C	
Equivalent Series Resistance	ESR	See Table 1			Ω	Customer specified
Drive Level	DL	-	100	200	μW	
Insulation Resistance	IR	500	-		m Ω	At 100VDC
Shunt Capacitance	C0	-	-	5.0	pF	
Aging per year	Fa	-5	-	+5	ppm	1st Year

Table 1

FREQUENCY RANGE	MODE OF VIBRATION	ESR (Ω) MAX
7.3728MHz \leq F0 \leq 10.000MHz	Fundamental	100
10.000MHz $<$ F0 \leq 12.000MHz	Fundamental	80
12.000MHz $<$ F0 \leq 13.000MHz	Fundamental	60
13.00MHz $<$ F0 \leq 16.000MHz	Fundamental	50
16.00MHz $<$ F0 \leq 20.00MHz	Fundamental	40
20.00MHz $<$ F0 \leq 30.00MHz	Fundamental	30
30.00MHz $<$ F0 \leq 90.00MHz	Overtone	100

ELECTRICAL PARAMETERS – FOR DIFFERENT PART CODE- Ta = 25°C

PART CODE	FREQUENCY RANGE	FREQUENCY TOLERANCE	LOAD CAPACITANCE	FREQUENCY STABILITY	OPERATING TEMPE. RANGE	EQUIVALENT SERIES RESISTANCE
	MHz	ppm	pF	ppm	°C	Ω Max.
YQ7M372800S40S	7.372800	±30	Series	±50	-40 ~ +85	100
YQ7M372800S416	7.372800	±30	16	±50	-40 ~ +85	100
YQ7M372800S418	7.372800	±30	18	±50	-40 ~ +85	100
YQ7M372800S420	7.372800	±30	20	±50	-40 ~ +85	100
YQ7M372800S430	7.372800	±30	30	±50	-40 ~ +85	100
YQ8M000000S40S	8.000000	±30	Series	±50	-40 ~ +85	100
YQ8M000000S416	8.000000	±30	16	±50	-40 ~ +85	100
YQ8M000000S418	8.000000	±30	18	±50	-40 ~ +85	100
YQ8M000000S420	8.000000	±30	20	±50	-40 ~ +85	100
YQ8M000000S430	8.000000	±30	30	±50	-40 ~ +85	100
YQ8M192000S416	8.192000	±30	16	±50	-40 ~ +85	100
YQ8M192000S418	8.192000	±30	18	±50	-40 ~ +85	100
YQ8M192000S420	8.192000	±30	20	±50	-40 ~ +85	100
YQ8M192000S430	8.192000	±30	30	±50	-40 ~ +85	100
YQ9M216000S416	9.216000	±30	16	±50	-40 ~ +85	100
YQ9M216000S418	9.216000	±30	18	±50	-40 ~ +85	100
YQ9M216000S420	9.216000	±30	20	±50	-40 ~ +85	100
YQ9M216000S430	9.216000	±30	30	±50	-40 ~ +85	100
YQ10M000000S40S	10.000000	±30	Series	±50	-40 ~ +85	100
YQ10M000000S416	10.000000	±30	16	±50	-40 ~ +85	100

ELECTRICAL PARAMETERS – FOR DIFFERENT PART CODE- Ta = 25°C

PART CODE	FREQUENCY RANGE	FREQUENCY TOLERANCE	LOAD CAPACITANCE	FREQUENCY STABILITY	OPERATING TEMPE. RANGE	EQUIVALENT SERIES RESISTANCE
	MHz	ppm	pF	ppm	°C	Ω Max.
YQ10M00000S418	10.000000	±30	18	±50	-40 ~ +85	100
YQ10M00000S420	10.000000	±30	20	±50	-40 ~ +85	100
YQ10M00000S430	10.000000	±30	30	±50	-40 ~ +85	100
YQ11M05920S416	11.059200	±30	16	±50	-40 ~ +85	80
YQ11M05920S418	11.059200	±30	18	±50	-40 ~ +85	80
YQ11M05920S420	11.059200	±30	20	±50	-40 ~ +85	80
YQ11M05920S430	11.059200	±30	30	±50	-40 ~ +85	80
YQ12M00000S40S	12.000000	±30	Series	±50	-40 ~ +85	80
YQ12M00000S416	12.000000	±30	16	±50	-40 ~ +85	80
YQ12M00000S418	12.000000	±30	18	±50	-40 ~ +85	80
YQ12M00000S420	12.000000	±30	20	±50	-40 ~ +85	80
YQ12M00000S430	12.000000	±30	30	±50	-40 ~ +85	80
YQ12M28800S416	12.288000	±30	16	±50	-40 ~ +85	60
YQ12M28800S418	12.288000	±30	18	±50	-40 ~ +85	60
YQ12M28800S420	12.288000	±30	20	±50	-40 ~ +85	60
YQ12M28800S430	12.288000	±30	30	±50	-40 ~ +85	60
YQ12M500S33418	12.500000	±30	18	±30	-40 ~ +85	60
YQ14M31818S416	14.31818	±30	16	±50	-40 ~ +85	50
YQ14M31818S418	14.31818	±30	18	±50	-40 ~ +85	50
YQ14M31818S420	14.31818	±30	20	±50	-40 ~ +85	50

ELECTRICAL PARAMETERS – FOR DIFFERENT PART CODE- Ta = 25°C

PART CODE	FREQUENCY RANGE	FREQUENCY TOLERANCE	LOAD CAPACITANCE	FREQUENCY STABILITY	OPERATING TEMPE. RANGE	EQUIVALENT SERIES RESISTANCE
	MHz	ppm	pF	ppm	°C	Ω Max.
YQ14M31818S430	14.31818	±30	30	±50	-40 ~ +85	50
YQ14M74560S416	14.74560	±30	16	±50	-40 ~ +85	50
YQ14M74560S418	14.74560	±30	18	±50	-40 ~ +85	50
YQ14M74560S420	14.74560	±30	20	±50	-40 ~ +85	50
YQ14M74560S430	14.74560	±30	30	±50	-40 ~ +85	50
YQ16M00000S416	16.00000	±30	16	±50	-40 ~ +85	50
YQ16M00000S418	16.00000	±30	18	±50	-40 ~ +85	50
YQ16M00000S420	16.00000	±30	20	±50	-40 ~ +85	50
YQ16M00000S430	16.00000	±30	30	±50	-40 ~ +85	50
YQ16M38400S416	16.38400	±30	16	±50	-40 ~ +85	40
YQ16M38400S418	16.38400	±30	18	±50	-40 ~ +85	40
YQ16M38400S420	16.38400	±30	20	±50	-40 ~ +85	40
YQ16M38400S430	16.38400	±30	30	±50	-40 ~ +85	40
YQ18M00000S416	18.00000	±30	16	±50	-40 ~ +85	40
YQ18M00000S418	18.00000	±30	18	±50	-40 ~ +85	40
YQ18M00000S420	18.00000	±30	20	±50	-40 ~ +85	40
YQ18M00000S430	18.00000	±30	30	±50	-40 ~ +85	40
YQ18M43200S416	18.43200	±30	16	±50	-40 ~ +85	40
YQ18M43200S418	18.43200	±30	18	±50	-40 ~ +85	40
YQ18M43200S420	18.43200	±30	20	±50	-40 ~ +85	40

ELECTRICAL PARAMETERS – FOR DIFFERENT PART CODE- Ta = 25°C

PART CODE	FREQUENCY RANGE	FREQUENCY TOLERANCE	LOAD CAPACITANCE	FREQUENCY STABILITY	OPERATING TEMPE. RANGE	EQUIVALENT SERIES RESISTANCE
	MHz	ppm	pF	ppm	°C	Ω Max.
YQ18M43200S430	18.43200	±30	30	±50	-40 ~ +85	40
YQ19M66080S416	19.66080	±30	16	±50	-40 ~ +85	40
YQ19M66080S418	19.66080	±30	18	±50	-40 ~ +85	40
YQ19M66080S420	19.66080	±30	20	±50	-40 ~ +85	40
YQ19M66080S430	19.66080	±30	30	±50	-40 ~ +85	40
YQ20M00000S416	20.00000	±30	16	±50	-40 ~ +85	40
YQ20M00000S418	20.00000	±30	18	±50	-40 ~ +85	40
YQ20M00000S420	20.00000	±30	20	±50	-40 ~ +85	40
YQ20M00000S430	20.00000	±30	30	±50	-40 ~ +85	40
YQ22M11840S416	22.11840	±30	16	±50	-40 ~ +85	30
YQ22M11840S418	22.11840	±30	18	±50	-40 ~ +85	30
YQ22M11840S420	22.11840	±30	20	±50	-40 ~ +85	30
YQ22M11840S430	22.11840	±30	30	±50	-40 ~ +85	30
YQ24M00000S416	24.00000	±30	16	±50	-40 ~ +85	30
YQ24M00000S418	24.00000	±30	18	±50	-40 ~ +85	30
YQ24M00000S420	24.00000	±30	20	±50	-40 ~ +85	30
YQ24M00000S430	24.00000	±30	30	±50	-40 ~ +85	30
YQ24M57600S416	24.57600	±30	16	±50	-40 ~ +85	30
YQ24M57600S418	24.57600	±30	18	±50	-40 ~ +85	30
YQ24M57600S420	24.57600	±30	20	±50	-40 ~ +85	30

ELECTRICAL PARAMETERS – FOR DIFFERENT PART CODE- Ta = 25°C

PART CODE	FREQUENCY RANGE	FREQUENCY TOLERANCE	LOAD CAPACITANCE	FREQUENCY STABILITY	OPERATING TEMPE. RANGE	EQUIVALENT SERIES RESISTANCE
	MHz	ppm	pF	ppm	°C	Ω Max.
YQ24M57600S430	24.57600	±30	30	±50	-40 ~ +85	30
YQ25M00000S416	25.00000	±30	16	±50	-40 ~ +85	30
YQ25M00000S418	25.00000	±30	18	±50	-40 ~ +85	30
YQ25M00000S420	25.00000	±30	20	±50	-40 ~ +85	30
YQ25M00000S430	25.00000	±30	30	±50	-40 ~ +85	30
YQ26M00000S416	26.00000	±30	16	±50	-40 ~ +85	30
YQ26M00000S418	26.00000	±30	18	±50	-40 ~ +85	30
YQ26M00000S420	26.00000	±30	20	±50	-40 ~ +85	30
YQ26M00000S430	26.00000	±30	30	±50	-40 ~ +85	30
YQ27M00000S416	27.00000	±30	16	±50	-40 ~ +85	30
YQ27M00000S418	27.00000	±30	18	±50	-40 ~ +85	30
YQ27M00000S420	27.00000	±30	20	±50	-40 ~ +85	30
YQ27M00000S430	27.00000	±30	30	±50	-40 ~ +85	30
YQ28M37500S416	28.37500	±30	16	±50	-40 ~ +85	30
YQ28M37500S418	28.37500	±30	18	±50	-40 ~ +85	30
YQ28M37500S420	28.37500	±30	20	±50	-40 ~ +85	30
YQ28M37500S430	28.37500	±30	30	±50	-40 ~ +85	30
YQ30M00000S416	30.00000	±30	16	±50	-40 ~ +85	30
YQ30M00000S418	30.00000	±30	18	±50	-40 ~ +85	30
YQ30M00000S420	30.00000	±30	20	±50	-40 ~ +85	30

TEST STANDARD

1. General Electrical Characteristics And Visual Testing

1.1 Lot classification : if the quantity is 1000 PCS or more, 1000 PCS is one lot

1.2 Sampling test method : MII-STD-105E G-II

1.3 Test level

A) High level defect : AQL 0.065% [200 pcs]

B) Medium level defect : AQL 0.25% [50 pcs]

C) Low level defect : AQL 0.4% [32 pcs]

1.4 Defect classification

A) High level

@No frequency

@Mixing

@Leak defect

B) Medium level - Electrical characteristic defect

@Frequency

@Oscillation

@Electrical current

@Other electrical characteristics defect

C) Visual

@Marking

@Welding

@Leads

@Other visual defect

Testing method and its standard can be modified depending on the customer's request.

2. Equivalent Circuits

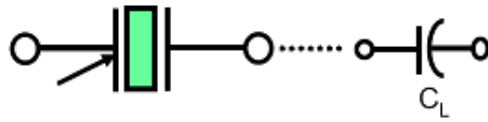

Symbol for crystal unit



CHARACTERISTICS

Units and values indicated with { } in this specification are the former units and the specified values.

Standard Atmospheric Conditions:

Unless otherwise specified the standard range of atmospheric conditions for making measurements and tests is as follows:

Ambient temperature: 15°C to 35°C

Relative humidity : 25% to 85%

Air pressure : 86 to 106 k Pa

If there is any doubt about the results measurements shall be made within the following limits:

Ambient temperature : $25 \pm 1^\circ\text{C}$

Relative humidity : 63% to 67%

Air pressure : 86 to 106 k Pa

Operating Temperature Range:

The operating temperature range is the range of ambient temperatures at which the quartz crystal oscillator can be stored without damage. Conditions are as specified elsewhere on these specifications.

Operating temperature range: -40°C to +85°C

Storage Temperature Range:

The storage temperature range is the range of ambient temperatures at which the quartz crystal oscillator can be stored without damage. Conditions are as specified elsewhere on these specifications.

Storage temperature range: -55°C to +125°C

RELIABILITY (MECHANICAL AND ENVIRONMENTAL ENDURANCE)

TEST ITEMS	TEST METHOD AND CONDITIONS	REQUIREMENTS
Vibration	a) Vibration Frequency: 10 To 55hz b) Vibration Amplitude: 1.5mm c) Cycle Time: 1~2min(10-55-10hz) d) Direction: X.Y.Z e) Duration: 2h/Each Direction, total 6Hours f) G-force: ≥5G	Frequency change: ±10ppm max. Resistance change: ± 15%rrmax
Shock	3 times free drop from 75cm height to hard wooden board of thickness more than 30mm.	Frequency change: ±10ppm max. Resistance change: ± 15%rrmax
Leakage	Put crystal units into a hermetic container and helium for 0.5-0.6.Mpa, and keep it for 1h; Check the leakage by a helium leak detector.	Leakage:1x10 ⁻⁸ mbar.L/s Max
Solderability	a) Dip the leads into flux(Rojin methanol) for 3~5s. b) Dip the leads into 245±5°C 99% SN dipping solution for 5s	The dipped part of the Leads should have 95% SN coating.
Soldering Heat Resistance Test	a) Perform electrical characteristics test before starting this procedure. b) Dip the leads into flux(Rojin methanol) 5±0.5s. c) Dip the leads into 260±5°C 99% SN dipping solution for 5s. d) Take the unit out ,store at room temperature for 30s then measure the Electrical characteristics.	Should pass sealing and visual test. Frequency change: ±10ppm max.
Leak Test	Use helium leak detector. Bombing pressure:5kg/cm ² Bombing time: 2 hours Leak should be less than 1e-8 atm.cc/sec.	Gas or air should not be detected.
High Temperature Endurance	The crystal units shall be put in somewhere for 500 hours at temperature of 125°C±5°C,then keep it for 1 to 2 hours under room temperature.	Frequency change: ±10ppm max. Resistance change: ± 15%rrmax

RELIABILITY (MECHANICAL AND ENVIRONMENTAL ENDURANCE)

TEST ITEMS	TEST METHOD AND CONDITIONS	REQUIREMENTS
Low Temperature Endurance	The crystal units shall be put in somewhere for 500 hours at temperature of -40°C, then keep it for 1 to 2 hours under room	Frequency change: ±10ppm max. Resistance change: ± 15%rrmax
Humidity Endurance	Somewhere at 40°C±5°C in relative humidity of 90%~95% for 72 hours, then keep it for one or two hours under room temperature	Frequency change: ± 10ppm max. Resistance change: ± 15%rrmax
Temperature Cycle	Temperature shift from low(-40°C) to high(100°C,keep 30 minutes),satisfy high(100°C) to low(-40°C, keep 30 minutes), then go up to room temperature for 10 cycles	Frequency change: ± 10ppm max. Resistance change: ± 15%rrmax
Lead Tensity	a) Fix the unit. b) Apply 2LB of weight axis to the leads. c) Time: 5s	Should pass sealing and visual test.
Lead Bending	a) Attach 1lb of weight to each of the leads. b) Bending angle: 90° (from the normal position to 45° opposite direction) c) Bending time: 3s(each direction) Number of bending: 2times a) Number of bending: 2times	Should pass sealing and visual test.
Marking Erase	Submerge the unit into ipa [isopropyl alcohol] Solution for 10minutes and brush the marking 10 times with a tooth brush.	Marking should not be erased.

SUGGESTED REFLOW PROFILE (For Reference Only)

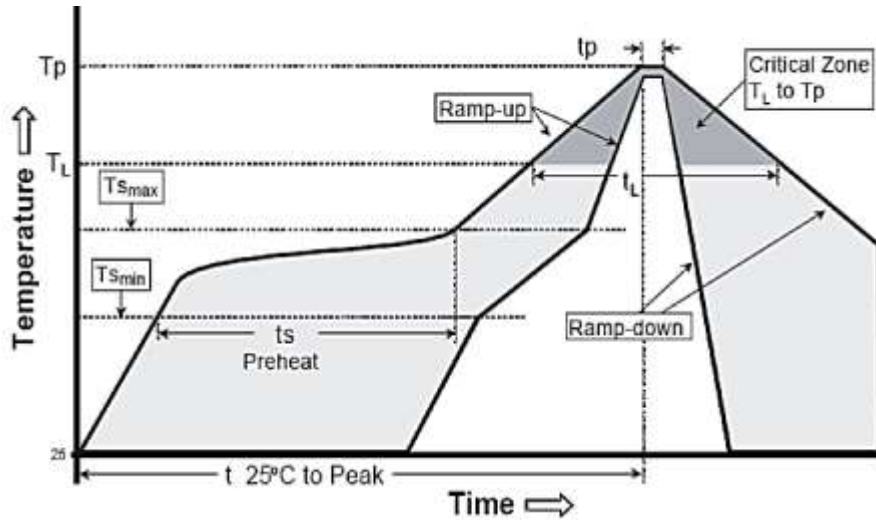

PROFILE FEATURE		HIGH-PB ASSEMBLY
Average Ramp-up Rate (T_s Max to T_p)		3°C/second Max
Preheat	Temperature Min (T_s Min.)	140°C
	Temperature Max (T_s Max.)	180°C
	Time (t_s Min. to t_s Max.)	70 ~ 100 seconds
Time maintained above	Temperature (T_L)	240°C
	Time (t_L)	20 ~ 50 seconds
Peak/Classification Temperature (T_p)		260 °C
Time within 5°C of actual Peak Temperature (t_p)		5 ~ 6 seconds
Ramp-down rate		6 °C /Second Max.
Time 25 °C to Peak Temperature		6 minutes Max.

TAPE AND REEL (1000pcs/Reel, Unit: mm)

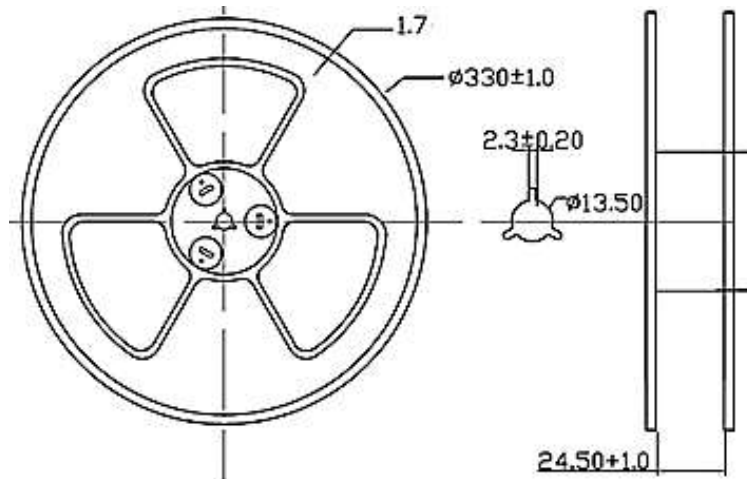
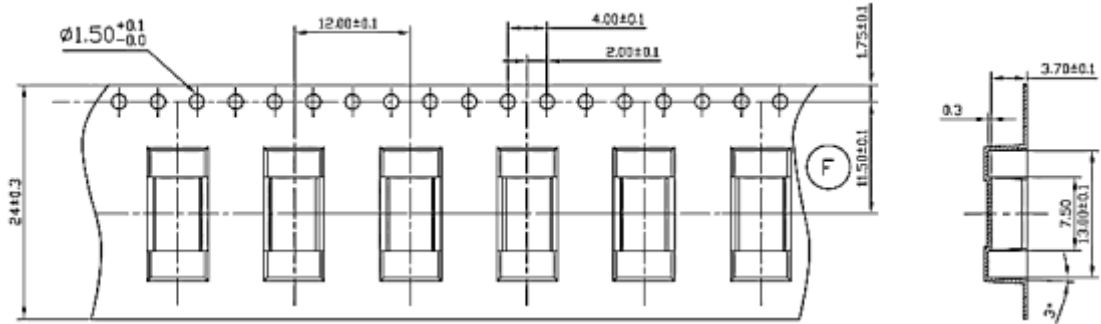

IMPORTANT NOTES AND DISCLAIMER

1. **ROHS COMPLIANCE:** The levels of RoHS restricted materials in this product are below the maximum concentration values (also referred to as the threshold limits) permitted for such substances, or are used in an exempted application, in accordance with EU RoHS Directive (EU) 2015/863 EC (RoHS3). RoHS Test Report for this product can be obtained at Download Center.
2. **REACH COMPLIANCE:** REACH substances of high concern (SVHCs) information is available for this product. Since the European Chemical Agency (ECHA) has published notice of their intent to frequently revise the SVHC listing for the foreseeable future, REACH Test Report for this product can be obtained at Download Center.
3. All Product parametric performance is indicated in the Electrical Characteristics for the listed herein test conditions, unless otherwise noted. Product performance may not be indicated by the Electrical Characteristics if operated under different conditions.
4. NextGen Component, Inc (*NextGen*) reserves the right to make changes to this document and its products and specifications at any time without notice. Customers should obtain and confirm the latest product information and specifications before final design, purchase or use.
5. *NextGen* makes no warranty, representation or guarantee regarding the suitability of its products for any particular purpose, not does *NextGen* assume any liability for application assistance or customer product design.
6. *NextGen* does not warrant or accept any liability with products which are purchased or used for any unintended or unauthorized application. No license is granted by implication or otherwise under any intellectual property rights of NextGen.
7. *NextGen* products are not authorized for use as critical components in life support devices or systems without express written approval by *NextGen*.
8. *NextGen* requires that customers first obtain an RMA (Returned Merchandise Authorization) number prior to returning any products. Returns must be made within 30 days of the date of invoice, be in the original packaging, unused and like-new condition. At the time of quoting or purchasing, a product may say that it is Non-Cancelable/ Non-Returnable (NCNR). These products are not returnable and not refundable.