



| | | |
|---|---|---|
| SPECIFICATION SHEET NO. | S0112 - YQ14M31818S430 | |
| ORIGINAL MFG/PART NO. | TGS Crystals/CCME 14M31818A30-30-50-40-50TLH/PMX308 /AMR1431803004F6 | |
| NEXTGEN PART CODE | YQ14M31818S430 | Indicate This Code For RFQ /Order |
| DATE | Jan. 12, 2025 | |
| REVISION | A1 | Updated With Most Recent Data |
| DESCRIPTION AND MAIN PARAMETRICS | <p>MHz SMD Crystal 4 pads, YQ series, Glass seal, Plastic Case, Dimension L12.5*W4.6*H3.7mm 14.31818MHz, Tolerance ±30ppm, Load Capacitor 30pF Frequency stability ±50ppm; Operating Temp. Range -40°C ~+85°C, ESR 50 ohm Max, Reflow Profile Condition 260 °C Max. Package in Tape/Reel, 1000pcs/Reel RoHS/RoHS III compliant, RoHS Annex III lead Exemption (exempt per RoHS EU 2015/863)</p> | |
| CUSTOMER | | |
| CUSTOMER PART NUMBER | | |
| CROSS REF. PART NUMBER | EPSON MA406 & MA506 | |
| MEMO | | |

| |
|---|
| VENDOR APPROVE |
| Issued/Checked/Approved <div style="display: flex; justify-content: space-around; margin-top: 10px;">    </div> |
| Effective Date: Jan. 12, 2025 |

| |
|-------------------------|
| CUSTOMER APPROVE |
| |
| Date: |

MAIN FEATURE

- MHz SMD Crystal L12.5*W4.6*H3.7mm 4 Pads
- Plastic case, Glass seal
- Low Profile and Short Lead time
- RoHS/RoHS III Compliant, RoHS Annex III Lead Exemption
(exempt per RoHS EU 2015/863)
- Moisture Sensitivity Level (MSL) Level 1
- Excellent Aging and Wide Frequency Range
- 4 Pad Fit EPSON MA406 & MA506 Footprint Surface Mount



Image shown is a representation only. Exact specifications should be obtained from the product dimension.



APPLICATION

- Microcontroller Systems, Microprocessors, Communication Interfaces
- Digital Signal Processors (DSPs), Test And Measurement Equipment

ELECTRICAL CHARACTERISTICS

- See Page 6 ~Page 12 For Different Part Code.
- All Products Parameters are Subject To NextGen Components' Final Confirmation.

HOW TO ORDER

- Please Follow Up Part Code Guide And Indicate NextGen Part Code YQ14M31818S430 For RFQ and Order.

PART CODE GUIDE

RFQ
[Request For Quotation](#)

| CODE | NAME | KEY SPECIFICATION OPTION |
|----------|-----------------------------------|---|
| YQ | Series Code | MHz SMD Crystal L12.5*W4.6*H3.7mm 4 Pads |
| 14M31818 | Frequency Range Code | 14M31818: 14.31818MHz or Custom Frequency Range by Page 6~ Page 12 |
| S | Internal Control Code | Letter A~Z, a~z or digits (0~9) |
| 430 | Parameters code | Special Parameters Code Letter A~Z, a~z or digits (1-9) |
| XX | Special/Custom Parameters Code | Blank: N/A XX: Letter A~Z, a~z or digits (0~9) for Special/Custom Parameters |

DIMENSION (Unit: Inch/mm)

Top View

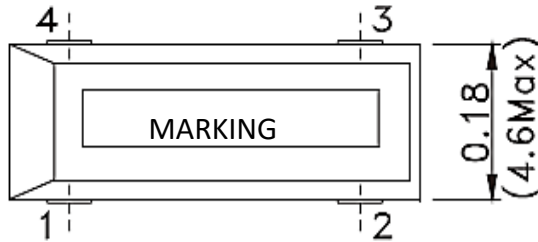

Side View

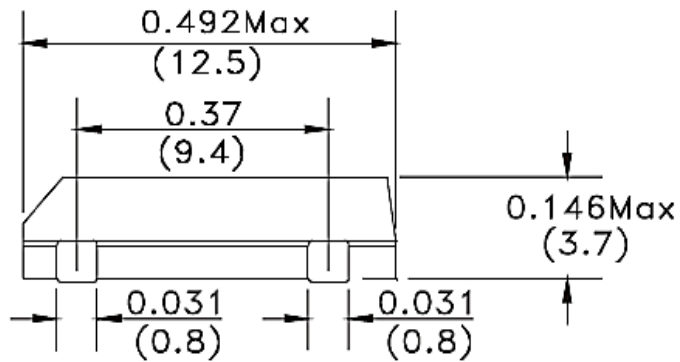

Side View

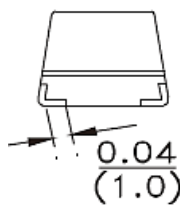

Note: Metal (Crystal inside) may be exposed on the top or bottom of plastic case. That will not be affect performance and reliability of the part in question

Electrode Arrangement

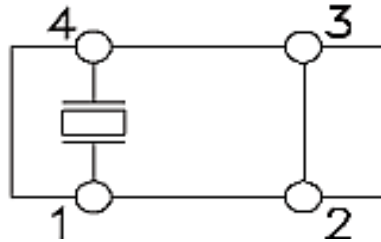

Connection: 1# Crystal; 2# Ground; 3# Ground; 4# Crystal

Solder Pattern (Unit: inch/mm)

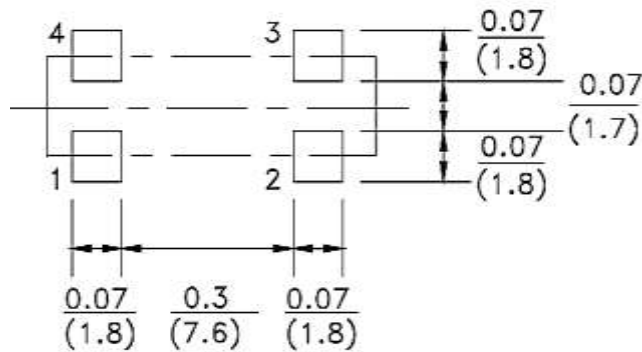

GENERAL SPECIFICATION

| PARAMETER | SYMBOL | VALUE | | | UNIT | CONDITION |
|------------------------------|---------------|-------------|----------|----------|------------|----------------------------|
| | | MIN. | TYPE | MAX. | | |
| Frequency Range | F0 | 7.3728 | - | 90.000 | MHz | Customer specified |
| Mode of Vibration Code | | Fundamental | | | | Optional: 3rd OT Or 5th OT |
| Frequency Tolerance | $\Delta F/F0$ | ± 20 | ± 30 | ± 50 | ppm | at 25°C ± 3 °C |
| Load Capacitance | CL | 6 | 18 | Series | pF | Customer specified |
| Frequency Stability | Tc | ± 30 | - | ± 50 | ppm | Customer specified |
| Operating Temp. Range | TOPR | -40 | - | +85 | °C | Standard |
| Storage Temp. Range | TSTG | -55 | - | +125 | °C | |
| Equivalent Series Resistance | ESR | See Table 1 | | | Ω | Customer specified |
| Drive Level | DL | - | 100 | 200 | μW | |
| Insulation Resistance | IR | 500 | - | | m Ω | At 100VDC |
| Shunt Capacitance | C0 | - | - | 5.0 | pF | |
| Aging per year | Fa | -5 | - | +5 | ppm | 1st Year |

Table 1

| FREQUENCY RANGE | MODE OF VIBRATION | ESR (Ω) MAX |
|--------------------------------------|-------------------|----------------------|
| 7.3728MHz \leq F0 \leq 10.000MHz | Fundamental | 100 |
| 10.000MHz< F0 \leq 12.000MHz | Fundamental | 80 |
| 12.000MHz< F0 \leq 13.000MHz | Fundamental | 60 |
| 13.00MHz< F0 \leq 16.000MHz | Fundamental | 50 |
| 16.00MHz< F0 \leq 20.00MHz | Fundamental | 40 |
| 20.00MHz< F0 \leq 30.00MHz | Fundamental | 30 |
| 30.00MHz< F0 \leq 90.00MHz | Overtone | 100 |

ELECTRICAL PARAMETERS – FOR DIFFERENT PART CODE- Ta = 25°C

| PART CODE | FREQUENCY RANGE | FREQUENCY TOLERANCE | LOAD CAPACITANCE | FREQUENCY STABILITY | OPERATING TEMPE. RANGE | EQUIVALENT SERIES RESISTANCE |
|-----------------|-----------------|---------------------|------------------|---------------------|------------------------|------------------------------|
| | MHz | ppm | pF | ppm | °C | Ω Max. |
| YQ7M372800S40S | 7.372800 | ±30 | Series | ±50 | -40 ~ +85 | 100 |
| YQ7M372800S416 | 7.372800 | ±30 | 16 | ±50 | -40 ~ +85 | 100 |
| YQ7M372800S418 | 7.372800 | ±30 | 18 | ±50 | -40 ~ +85 | 100 |
| YQ7M372800S420 | 7.372800 | ±30 | 20 | ±50 | -40 ~ +85 | 100 |
| YQ7M372800S430 | 7.372800 | ±30 | 30 | ±50 | -40 ~ +85 | 100 |
| YQ8M000000S40S | 8.000000 | ±30 | Series | ±50 | -40 ~ +85 | 100 |
| YQ8M000000S416 | 8.000000 | ±30 | 16 | ±50 | -40 ~ +85 | 100 |
| YQ8M000000S418 | 8.000000 | ±30 | 18 | ±50 | -40 ~ +85 | 100 |
| YQ8M000000S420 | 8.000000 | ±30 | 20 | ±50 | -40 ~ +85 | 100 |
| YQ8M000000S430 | 8.000000 | ±30 | 30 | ±50 | -40 ~ +85 | 100 |
| YQ8M192000S416 | 8.192000 | ±30 | 16 | ±50 | -40 ~ +85 | 100 |
| YQ8M192000S418 | 8.192000 | ±30 | 18 | ±50 | -40 ~ +85 | 100 |
| YQ8M192000S420 | 8.192000 | ±30 | 20 | ±50 | -40 ~ +85 | 100 |
| YQ8M192000S430 | 8.192000 | ±30 | 30 | ±50 | -40 ~ +85 | 100 |
| YQ9M216000S416 | 9.216000 | ±30 | 16 | ±50 | -40 ~ +85 | 100 |
| YQ9M216000S418 | 9.216000 | ±30 | 18 | ±50 | -40 ~ +85 | 100 |
| YQ9M216000S420 | 9.216000 | ±30 | 20 | ±50 | -40 ~ +85 | 100 |
| YQ9M216000S430 | 9.216000 | ±30 | 30 | ±50 | -40 ~ +85 | 100 |
| YQ10M000000S40S | 10.000000 | ±30 | Series | ±50 | -40 ~ +85 | 100 |
| YQ10M000000S416 | 10.000000 | ±30 | 16 | ±50 | -40 ~ +85 | 100 |

ELECTRICAL PARAMETERS – FOR DIFFERENT PART CODE- Ta = 25°C

| PART CODE | FREQUENCY RANGE | FREQUENCY TOLERANCE | LOAD CAPACITANCE | FREQUENCY STABILITY | OPERATING TEMPE. RANGE | EQUIVALENT SERIES RESISTANCE |
|-----------------------|-----------------|---------------------|------------------|---------------------|------------------------|------------------------------|
| | MHz | ppm | pF | ppm | °C | Ω Max. |
| YQ10M00000S418 | 10.000000 | ±30 | 18 | ±50 | -40 ~ +85 | 100 |
| YQ10M00000S420 | 10.000000 | ±30 | 20 | ±50 | -40 ~ +85 | 100 |
| YQ10M00000S430 | 10.000000 | ±30 | 30 | ±50 | -40 ~ +85 | 100 |
| YQ11M05920S416 | 11.059200 | ±30 | 16 | ±50 | -40 ~ +85 | 80 |
| YQ11M05920S418 | 11.059200 | ±30 | 18 | ±50 | -40 ~ +85 | 80 |
| YQ11M05920S420 | 11.059200 | ±30 | 20 | ±50 | -40 ~ +85 | 80 |
| YQ11M05920S430 | 11.059200 | ±30 | 30 | ±50 | -40 ~ +85 | 80 |
| YQ12M00000S40S | 12.000000 | ±30 | Series | ±50 | -40 ~ +85 | 80 |
| YQ12M00000S416 | 12.000000 | ±30 | 16 | ±50 | -40 ~ +85 | 80 |
| YQ12M00000S418 | 12.000000 | ±30 | 18 | ±50 | -40 ~ +85 | 80 |
| YQ12M00000S420 | 12.000000 | ±30 | 20 | ±50 | -40 ~ +85 | 80 |
| YQ12M00000S430 | 12.000000 | ±30 | 30 | ±50 | -40 ~ +85 | 80 |
| YQ12M28800S416 | 12.288000 | ±30 | 16 | ±50 | -40 ~ +85 | 60 |
| YQ12M28800S418 | 12.288000 | ±30 | 18 | ±50 | -40 ~ +85 | 60 |
| YQ12M28800S420 | 12.288000 | ±30 | 20 | ±50 | -40 ~ +85 | 60 |
| YQ12M28800S430 | 12.288000 | ±30 | 30 | ±50 | -40 ~ +85 | 60 |
| YQ12M500S33418 | 12.500000 | ±30 | 18 | ±30 | -40 ~ +85 | 60 |
| YQ14M31818S416 | 14.31818 | ±30 | 16 | ±50 | -40 ~ +85 | 50 |
| YQ14M31818S418 | 14.31818 | ±30 | 18 | ±50 | -40 ~ +85 | 50 |
| YQ14M31818S420 | 14.31818 | ±30 | 20 | ±50 | -40 ~ +85 | 50 |

ELECTRICAL PARAMETERS – FOR DIFFERENT PART CODE- Ta = 25°C

| PART CODE | FREQUENCY RANGE | FREQUENCY TOLERANCE | LOAD CAPACITANCE | FREQUENCY STABILITY | OPERATING TEMPE. RANGE | EQUIVALENT SERIES RESISTANCE |
|--------------------------------|-----------------|---------------------|------------------|---------------------|------------------------|------------------------------|
| | MHz | ppm | pF | ppm | °C | Ω Max. |
| YQ14M31818S430 | 14.31818 | ±30 | 30 | ±50 | -40 ~ +85 | 50 |
| YQ14M74560S416 | 14.74560 | ±30 | 16 | ±50 | -40 ~ +85 | 50 |
| YQ14M74560S418 | 14.74560 | ±30 | 18 | ±50 | -40 ~ +85 | 50 |
| YQ14M74560S420 | 14.74560 | ±30 | 20 | ±50 | -40 ~ +85 | 50 |
| YQ14M74560S430 | 14.74560 | ±30 | 30 | ±50 | -40 ~ +85 | 50 |
| YQ16M00000S416 | 16.00000 | ±30 | 16 | ±50 | -40 ~ +85 | 50 |
| YQ16M00000S418 | 16.00000 | ±30 | 18 | ±50 | -40 ~ +85 | 50 |
| YQ16M00000S420 | 16.00000 | ±30 | 20 | ±50 | -40 ~ +85 | 50 |
| YQ16M00000S430 | 16.00000 | ±30 | 30 | ±50 | -40 ~ +85 | 50 |
| YQ16M38400S416 | 16.38400 | ±30 | 16 | ±50 | -40 ~ +85 | 40 |
| YQ16M38400S418 | 16.38400 | ±30 | 18 | ±50 | -40 ~ +85 | 40 |
| YQ16M38400S420 | 16.38400 | ±30 | 20 | ±50 | -40 ~ +85 | 40 |
| YQ16M38400S430 | 16.38400 | ±30 | 30 | ±50 | -40 ~ +85 | 40 |
| YQ18M00000S416 | 18.00000 | ±30 | 16 | ±50 | -40 ~ +85 | 40 |
| YQ18M00000S418 | 18.00000 | ±30 | 18 | ±50 | -40 ~ +85 | 40 |
| YQ18M00000S420 | 18.00000 | ±30 | 20 | ±50 | -40 ~ +85 | 40 |
| YQ18M00000S430 | 18.00000 | ±30 | 30 | ±50 | -40 ~ +85 | 40 |
| YQ18M43200S416 | 18.43200 | ±30 | 16 | ±50 | -40 ~ +85 | 40 |
| YQ18M43200S418 | 18.43200 | ±30 | 18 | ±50 | -40 ~ +85 | 40 |
| YQ18M43200S420 | 18.43200 | ±30 | 20 | ±50 | -40 ~ +85 | 40 |

ELECTRICAL PARAMETERS – FOR DIFFERENT PART CODE- Ta = 25°C

| PART CODE | FREQUENCY RANGE | FREQUENCY TOLERANCE | LOAD CAPACITANCE | FREQUENCY STABILITY | OPERATING TEMPE. RANGE | EQUIVALENT SERIES RESISTANCE |
|----------------|-----------------|---------------------|------------------|---------------------|------------------------|------------------------------|
| | MHz | ppm | pF | ppm | °C | Ω Max. |
| YQ18M43200S430 | 18.43200 | ±30 | 30 | ±50 | -40 ~ +85 | 40 |
| YQ19M66080S416 | 19.66080 | ±30 | 16 | ±50 | -40 ~ +85 | 40 |
| YQ19M66080S418 | 19.66080 | ±30 | 18 | ±50 | -40 ~ +85 | 40 |
| YQ19M66080S420 | 19.66080 | ±30 | 20 | ±50 | -40 ~ +85 | 40 |
| YQ19M66080S430 | 19.66080 | ±30 | 30 | ±50 | -40 ~ +85 | 40 |
| YQ20M00000S416 | 20.00000 | ±30 | 16 | ±50 | -40 ~ +85 | 40 |
| YQ20M00000S418 | 20.00000 | ±30 | 18 | ±50 | -40 ~ +85 | 40 |
| YQ20M00000S420 | 20.00000 | ±30 | 20 | ±50 | -40 ~ +85 | 40 |
| YQ20M00000S430 | 20.00000 | ±30 | 30 | ±50 | -40 ~ +85 | 40 |
| YQ22M11840S416 | 22.11840 | ±30 | 16 | ±50 | -40 ~ +85 | 30 |
| YQ22M11840S418 | 22.11840 | ±30 | 18 | ±50 | -40 ~ +85 | 30 |
| YQ22M11840S420 | 22.11840 | ±30 | 20 | ±50 | -40 ~ +85 | 30 |
| YQ22M11840S430 | 22.11840 | ±30 | 30 | ±50 | -40 ~ +85 | 30 |
| YQ24M00000S416 | 24.00000 | ±30 | 16 | ±50 | -40 ~ +85 | 30 |
| YQ24M00000S418 | 24.00000 | ±30 | 18 | ±50 | -40 ~ +85 | 30 |
| YQ24M00000S420 | 24.00000 | ±30 | 20 | ±50 | -40 ~ +85 | 30 |
| YQ24M00000S430 | 24.00000 | ±30 | 30 | ±50 | -40 ~ +85 | 30 |
| YQ24M57600S416 | 24.57600 | ±30 | 16 | ±50 | -40 ~ +85 | 30 |
| YQ24M57600S418 | 24.57600 | ±30 | 18 | ±50 | -40 ~ +85 | 30 |
| YQ24M57600S420 | 24.57600 | ±30 | 20 | ±50 | -40 ~ +85 | 30 |

ELECTRICAL PARAMETERS – FOR DIFFERENT PART CODE- Ta = 25°C

| PART CODE | FREQUENCY RANGE | FREQUENCY TOLERANCE | LOAD CAPACITANCE | FREQUENCY STABILITY | OPERATING TEMPE. RANGE | EQUIVALENT SERIES RESISTANCE |
|----------------|-----------------|---------------------|------------------|---------------------|------------------------|------------------------------|
| | MHz | ppm | pF | ppm | °C | Ω Max. |
| YQ24M57600S430 | 24.57600 | ±30 | 30 | ±50 | -40 ~ +85 | 30 |
| YQ25M00000S416 | 25.00000 | ±30 | 16 | ±50 | -40 ~ +85 | 30 |
| YQ25M00000S418 | 25.00000 | ±30 | 18 | ±50 | -40 ~ +85 | 30 |
| YQ25M00000S420 | 25.00000 | ±30 | 20 | ±50 | -40 ~ +85 | 30 |
| YQ25M00000S430 | 25.00000 | ±30 | 30 | ±50 | -40 ~ +85 | 30 |
| YQ26M00000S416 | 26.00000 | ±30 | 16 | ±50 | -40 ~ +85 | 30 |
| YQ26M00000S418 | 26.00000 | ±30 | 18 | ±50 | -40 ~ +85 | 30 |
| YQ26M00000S420 | 26.00000 | ±30 | 20 | ±50 | -40 ~ +85 | 30 |
| YQ26M00000S430 | 26.00000 | ±30 | 30 | ±50 | -40 ~ +85 | 30 |
| YQ27M00000S416 | 27.00000 | ±30 | 16 | ±50 | -40 ~ +85 | 30 |
| YQ27M00000S418 | 27.00000 | ±30 | 18 | ±50 | -40 ~ +85 | 30 |
| YQ27M00000S420 | 27.00000 | ±30 | 20 | ±50 | -40 ~ +85 | 30 |
| YQ27M00000S430 | 27.00000 | ±30 | 30 | ±50 | -40 ~ +85 | 30 |
| YQ28M37500S416 | 28.37500 | ±30 | 16 | ±50 | -40 ~ +85 | 30 |
| YQ28M37500S418 | 28.37500 | ±30 | 18 | ±50 | -40 ~ +85 | 30 |
| YQ28M37500S420 | 28.37500 | ±30 | 20 | ±50 | -40 ~ +85 | 30 |
| YQ28M37500S430 | 28.37500 | ±30 | 30 | ±50 | -40 ~ +85 | 30 |
| YQ30M00000S416 | 30.00000 | ±30 | 16 | ±50 | -40 ~ +85 | 30 |
| YQ30M00000S418 | 30.00000 | ±30 | 18 | ±50 | -40 ~ +85 | 30 |
| YQ30M00000S420 | 30.00000 | ±30 | 20 | ±50 | -40 ~ +85 | 30 |

ELECTRICAL PARAMETERS – FOR DIFFERENT PART CODE- Ta = 25°C

| PART CODE | FREQUENCY RANGE | FREQUENCY TOLERANCE | LOAD CAPACITANCE | FREQUENCY STABILITY | OPERATING TEMPE. RANGE | EQUIVALENT SERIES RESISTANCE |
|----------------|-----------------|---------------------|------------------|---------------------|------------------------|------------------------------|
| | MHz | ppm | pF | ppm | °C | Ω Max. |
| YQ30M00000S430 | 30.00000 | ±30 | 30 | ±50 | -40 ~ +85 | 30 |
| YQ32M00000S416 | 32.00000 | ±30 | 16 | ±50 | -40 ~ +85 | 100 |
| YQ32M00000S418 | 32.00000 | ±30 | 18 | ±50 | -40 ~ +85 | 100 |
| YQ32M00000S420 | 32.00000 | ±30 | 20 | ±50 | -40 ~ +85 | 100 |
| YQ32M00000S430 | 32.00000 | ±30 | 30 | ±50 | -40 ~ +85 | 100 |
| YQ40M00000S416 | 40.00000 | ±30 | 16 | ±50 | -40 ~ +85 | 100 |
| YQ40M00000S418 | 40.00000 | ±30 | 18 | ±50 | -40 ~ +85 | 100 |
| YQ40M00000S420 | 40.00000 | ±30 | 20 | ±50 | -40 ~ +85 | 100 |
| YQ40M00000S430 | 40.00000 | ±30 | 30 | ±50 | -40 ~ +85 | 100 |
| | | | | | | |
| | | | | | | |
| | | | | | | |
| | | | | | | |
| | | | | | | |
| | | | | | | |
| | | | | | | |
| | | | | | | |
| | | | | | | |
| | | | | | | |
| | | | | | | |
| | | | | | | |
| | | | | | | |

TEST STANDARD

1. General Electrical Characteristics And Visual Testing

1.1 Lot classification : if the quantity is 1000 PCS or more, 1000 PCS is one lot

1.2 Sampling test method : MII-STD-105E G-II

1.3 Test level

A) High level defect : AQL 0.065% [200 pcs]

B) Medium level defect : AQL 0.25% [50 pcs]

C) Low level defect : AQL 0.4% [32 pcs]

1.4 Defect classification

A) High level

@No frequency

@Mixing

@Leak defect

B) Medium level - Electrical characteristic defect

@Frequency

@Oscillation

@Electrical current

@Other electrical characteristics defect

C) Visual

@Marking

@Welding

@Leads

@Other visual defect

Testing method and its standard can be modified depending on the customer's request.

2. Equivalent Circuits

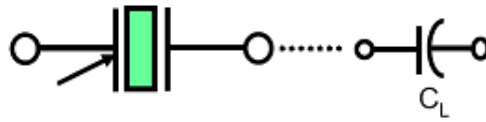

Symbol for crystal unit

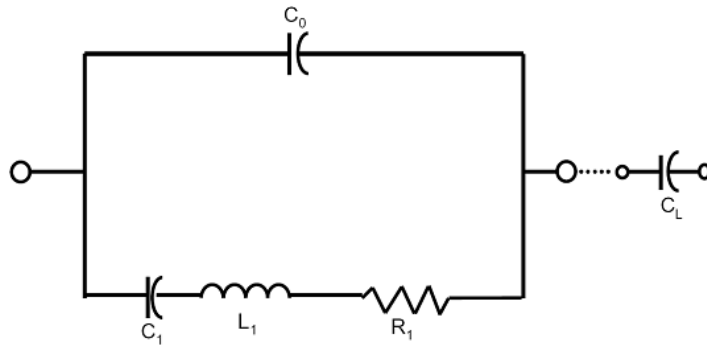

CHARACTERISTICS

Units and values indicated with { } in this specification are the former units and the specified values.

Standard Atmospheric Conditions:

Unless otherwise specified the standard range of atmospheric conditions for making measurements and tests is as follows:

Ambient temperature: 15°C to 35°C

Relative humidity : 25% to 85%

Air pressure : 86 to 106 k Pa

If there is any doubt about the results measurements shall be made within the following limits:

Ambient temperature : $25 \pm 1^\circ\text{C}$

Relative humidity : 63% to 67%

Air pressure : 86 to 106 k Pa

Operating Temperature Range:

The operating temperature range is the range of ambient temperatures at which the quartz crystal oscillator can be stored without damage. Conditions are as specified elsewhere on these specifications.

Operating temperature range: -40°C to +85°C

Storage Temperature Range:

The storage temperature range is the range of ambient temperatures at which the quartz crystal oscillator can be stored without damage. Conditions are as specified elsewhere on these specifications.

Storage temperature range: -55°C to +125°C

RELIABILITY (MECHANICAL AND ENVIRONMENTAL ENDURANCE)

| TEST ITEMS | TEST METHOD AND CONDITIONS | REQUIREMENTS |
|--------------------------------|---|--|
| Vibration | a) Vibration Frequency: 10 To 55hz b) Vibration Amplitude: 1.5mm c) Cycle Time: 1~2min(10-55-10hz) d) Direction: X.Y.Z e) Duration: 2h/Each Direction, total 6Hours f) G-force: ≥5G | Frequency change: ±10ppm max. Resistance change: ± 15%rrmax |
| Shock | 3 times free drop from 75cm height to hard wooden board of thickness more than 30mm. | Frequency change: ±10ppm max. Resistance change: ± 15%rrmax |
| Leakage | Put crystal units into a hermetic container and helium for 0.5-0.6.Mpa, and keep it for 1h; Check the leakage by a helium leak detector. | Leakage:1x10 ⁻⁸ mbar.L/s Max |
| Solderability | a) Dip the leads into flux(Rojin methanol) for 3~5s. b) Dip the leads into 245±5°C 99% SN dipping solution for 5s | The dipped part of the Leads should have 95% SN coating. |
| Soldering Heat Resistance Test | a) Perform electrical characteristics test before starting this procedure. b) Dip the leads into flux(Rojin methanol) 5±0.5s. c) Dip the leads into 260±5°C 99% SN dipping solution for 5s. d) Take the unit out ,store at room temperature for 30s then measure the Electrical characteristics. | Should pass sealing and visual test. Frequency change: ±10ppm max. |
| Leak Test | Use helium leak detector. Bombing pressure:5kg/cm ² Bombing time: 2 hours Leak should be less than 1e-8 atm.cc/sec. | Gas or air should not be detected. |
| High Temperature Endurance | The crystal units shall be put in somewhere for 500 hours at temperature of 125°C±5°C,then keep it for 1 to 2 hours under room temperature. | Frequency change: ±10ppm max. Resistance change: ± 15%rrmax |

RELIABILITY (MECHANICAL AND ENVIRONMENTAL ENDURANCE)

| TEST ITEMS | TEST METHOD AND CONDITIONS | REQUIREMENTS |
|---------------------------|---|--|
| Low Temperature Endurance | The crystal units shall be put in somewhere for 500 hours at temperature of -40°C, then keep it for 1 to 2 hours under room | Frequency change: ±10ppm max. Resistance change: ± 15%rrmax |
| Humidity Endurance | Somewhere at 40°C±5°C in relative humidity of 90%~95% for 72 hours, then keep it for one or two hours under room temperature | Frequency change: ±10ppm max. Resistance change: ± 15%rrmax |
| Temperature Cycle | Temperature shift from low(-40°C) to high(100°C,keep 30 minutes),satisfy high(100°C) to low(-40°C, keep 30 minutes), then go up to room temperature for 10 cycles | Frequency change: ±10ppm max. Resistance change: ± 15%rrmax |
| Lead Tensity | a) Fix the unit. b) Apply 2LB of weight axis to the leads. c) Time: 5s | Should pass sealing and visual test. |
| Lead Bending | a) Attach 1lb of weight to each of the leads. b) Bending angle: 90° (from the normal position to 45° opposite direction) c) Bending time: 3s(each direction) Number of bending: 2times a) Number of bending: 2times | Should pass sealing and visual test. |
| Marking Erase | Submerge the unit into ipa [isopropyl alcohol] Solution for 10minutes and brush the marking 10 times with a tooth brush. | Marking should not be erased. |

SUGGESTED REFLOW PROFILE (For Reference Only)

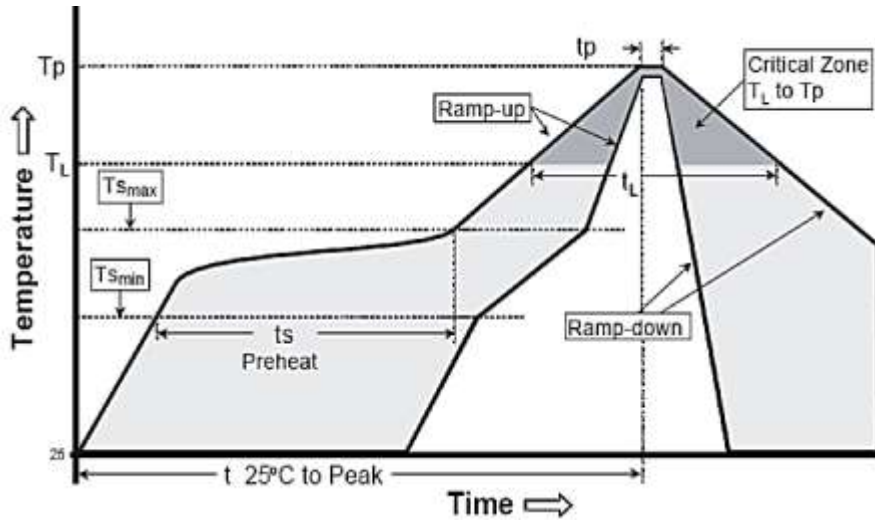

| PROFILE FEATURE | | HIGH-PB ASSEMBLY |
|---|---------------------------|-------------------|
| Average Ramp-up Rate (Ts Max to Tp) | | 3°C/second Max |
| Preheat | Temperature Min (Ts Min.) | 140°C |
| | Temperature Max (Ts Max.) | 180°C |
| | Time (ts Min. to ts Max.) | 70 ~ 100 seconds |
| Time maintained above | Temperature (Tl) | 240°C |
| | Time (tl) | 20 ~ 50 seconds |
| Peak/Classification Temperature (Tp) | | 260 °C |
| Time within 5°C of actual Peak Temperature (tp) | | 5 ~ 6 seconds |
| Ramp-down rate | | 6 °C /Second Max. |
| Time 25 °C to Peak Temperature | | 6 minutes Max. |

TAPE AND REEL (1000pcs/Reel, Unit: mm)

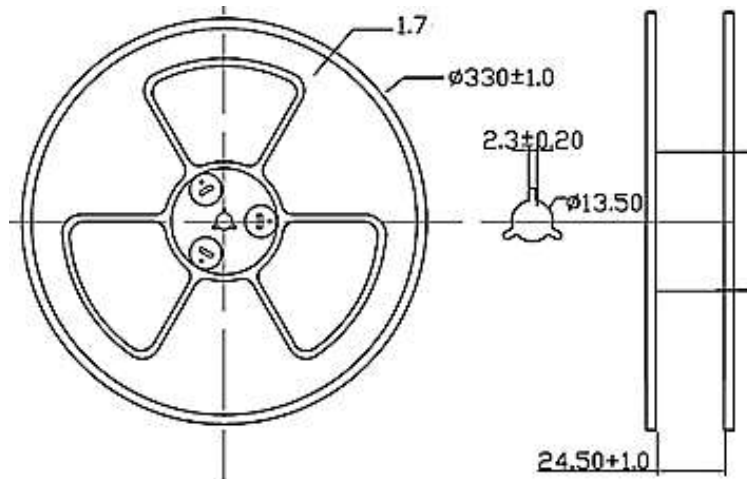
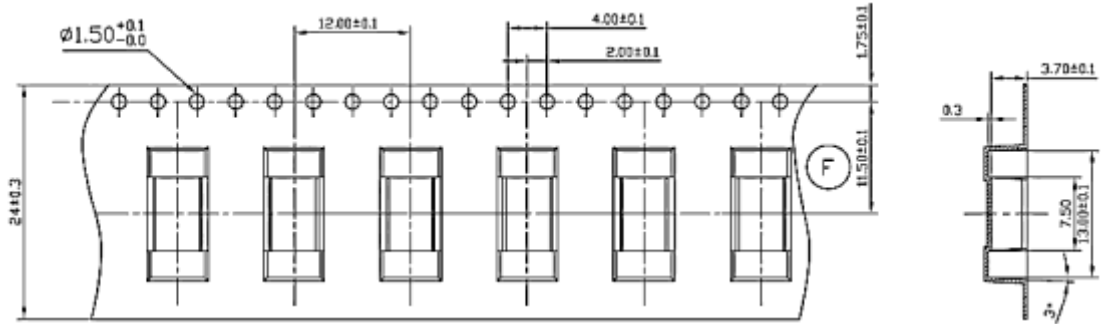

IMPORTANT NOTES AND DISCLAIMER

1. **ROHS COMPLIANCE:** The levels of RoHS restricted materials in this product are below the maximum concentration values (also referred to as the threshold limits) permitted for such substances, or are used in an exempted application, in accordance with EU RoHS Directive (EU) 2015/863 EC (RoHS3). RoHS Test Report for this product can be obtained at Download Center.
2. **REACH COMPLIANCE:** REACH substances of high concern (SVHCs) information is available for this product. Since the European Chemical Agency (ECHA) has published notice of their intent to frequently revise the SVHC listing for the foreseeable future, REACH Test Report for this product can be obtained at Download Center.
3. All Product parametric performance is indicated in the Electrical Characteristics for the listed herein test conditions, unless otherwise noted. Product performance may not be indicated by the Electrical Characteristics if operated under different conditions.
4. NextGen Component, Inc (*NextGen*) reserves the right to make changes to this document and its products and specifications at any time without notice. Customers should obtain and confirm the latest product information and specifications before final design, purchase or use.
5. *NextGen* makes no warranty, representation or guarantee regarding the suitability of its products for any particular purpose, not does *NextGen* assume any liability for application assistance or customer product design.
6. *NextGen* does not warrant or accept any liability with products which are purchased or used for any unintended or unauthorized application. No license is granted by implication or otherwise under any intellectual property rights of NextGen.
7. *NextGen* products are not authorized for use as critical components in life support devices or systems without express written approval by *NextGen*.
8. *NextGen* requires that customers first obtain an RMA (Returned Merchandise Authorization) number prior to returning any products. Returns must be made within 30 days of the date of invoice, be in the original packaging, unused and like-new condition. At the time of quoting or purchasing, a product may say that it is Non-Cancelable/ Non-Returnable (NCNR). These products are not returnable and not refundable.