



SPECIFICATION SHEET NO.	S0112-YN31K25000S100	
ORIGINAL MFG/PART NO.	TGS Crystals/CCMA 31K25A30-12.5-40-50TLH	
NEXTGEN PART CODE	YN31K25000S100	Indicate This Code For RFQ/Order
DATE	Jan. 12, 2025	
REVISION	A1	Updated With Most Recent Data
DESCRIPTION AND MAIN PARAMETRICS	<p>KHz SMD Crystals With Metal Lid YN Series, Dimension: \varnothing2.0*L6.0mm, 31.250000KHz, Tolerance: \pm30ppm, Load Capacitance (CL): 12.5pF</p> <p>ESR 50 Kohm Max, Operating Temp. Range -40°C ~+85°C</p> <p>Reflow Profile Condition 260 °C Max.</p> <p>Packed in Tape/Reel, 3000pcs/Reel</p> <p>RoHS/RoHS III compliant, RoHS Annex III lead Exemption (Exempt per RoHS EU 2015/863)</p>	
CUSTOMER		
CUSTOMER PART NUMBER		
CROSS PART NUMBER		
MEMO		

VENDOR APPROVE		
Issued/Checked/Approved		 
Date: Jan. 12, 2025		

CUSTOMER APPROVE	
Date:	

MAIN FEATURE

- KHz SMD Crystals With Metal Lid, YN Series
- Dimension: $\varnothing 2.0 \times L6.0$ mm,
- Industry Standard
- Low Cost, High Precision, High Frequency Stability
- Reflow Profile Condition 260 °C Max.
- Operating Temperature Range: -40~+85°C
- Load Capacitance(CL) standard 12.5pF
- Low ESR 50 Kohm Max.
- Moisture Sensitivity Level (MSL) 1 (Unlimited)
- RoHS/RoHS III compliant, RoHS Annex III lead Exemption (exempt per RoHS EU 2015/863)



*Image shown is a representation only.
Exact specifications should be obtained
from the product dimension.*



MAIN APPLICATION

- Clock Source For Portable Devices
- Mobile Communications And Consumer Devices, Etc.
- Smart Card And Wearable Devices

ELECTRICAL CHARACTERISTICS

- See Page 5 ~Page 7 For Different Part Code
- All Products Parameters are Subject To NextGen Components' Final Confirmation.

HOW TO ORDER

- Please Follow Up Part Code Guide And Indicate Part Code YN31K25000S100 For RFQ/Order.

PART CODE GUIDE

RFQ
[Request For Quotation](#)

CODE	NAME	KEY SPECIFICATION OPTION
YN	Product Index	KHz SMD Crystals With Metal Lid, Ø2.0*L6.0mm
31K25	Frequency Range	31K25: 31.25KHz or Custom Frequency Range by Page 6~ Page 7
000S	Internal Control Code	Special letter A~Z , a~z or digits (1-9)
100	Parameters Code	Letter A~Z, a~z or Digits (1-9)
XX	Special/Custom Parameters Code	Blank: N/A XX: Letter A~Z, a~z or digits (0~9) for Special/Custom Parameters

DIMENSION (Unit: mm, Case With Metal Lid, $\varnothing 2.0 \times L6.0$ mm)

Top View

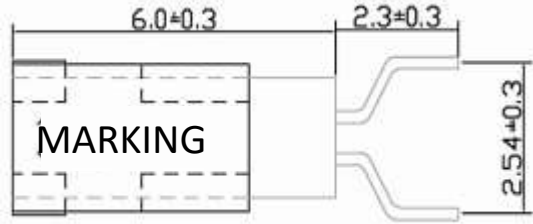

Side View



Side View

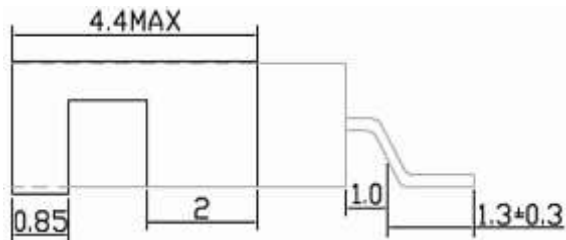

Recommend
Pad Layout

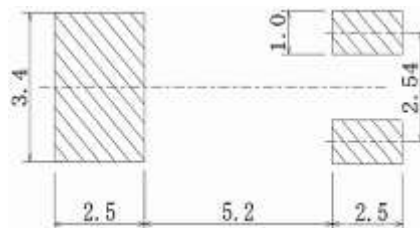

GENERAL ELECTRICAL PARAMETERS

PARAMETERS	SYMBOL	UNITS	VALUE			CONDITION
			MIN.	TYP.	MAX.	
Frequency Range	F0	KHz	32.000	-	153.60	Customer specified
Frequency Temp. Coefficient	$\Delta f/f_0$	ppm/C ²	-0.034 ± 0.006			
Turnover Temperature	T _m	°C	20	25	30	
Operating Temperature Range	T _{OP}	°C	-40		+85	
Storage Temperature Range	T _{ST}	°C	-55		+125	
Quality Factor	Q				60000	
Shunt Capacitance	C0	pF	0.9	1.35	2.0	
Motional Capacitance	C1	Ff	2.3		3.0	
Insulation Resistance	IR	mΩ	500			DC100V ± 15V
Drive Level	DL	μW			1	
Capacitance Ratio	R			450		
Aging per Year	Δ/f	ppm	±3		±5	@25°C±3°C
Moist are Sensitivity Level	MSL		1			J-STD-033

MAIN ELECTRICAL PARAMETERS - Ta = 25°C

NEXTGEN PART CODE	FREQUENCY RANGE	FREQUENCY TOLERANCE	LOAD CAPACITANCE	OPERATING TEMPERATURE	ESR MAX.
	KHz	ppm	pF	°C	KΩ
YN30K72000S100	30.7200	±30	12.5	-40 ~+85	50
YN30K72000S101	30.7200	±10	12.5	-40 ~+85	50
YN30K72000S102	30.7200	±20	12.5	-40 ~+85	50
YN31K25000S100	31.2500	±30	12.5	-40 ~+85	50
YN31K25000S101	31.2500	±10	12.5	-40 ~+85	50
YN31K25000S102	31.2500	±20	12.5	-40 ~+85	50
YN32K00000S100	32.0000	±30	12.5	-40 ~+85	50
YN32K00000S101	32.0000	±10	12.5	-40 ~+85	50
YN32K00000S102	32.0000	±20	12.5	-40 ~+85	50
YN32K76800S100	32.7680	±30	12.5	-40 ~+85	50
YN32K76800S101	32.7680	±10	12.5	-40 ~+85	50
YN32K76800S102	32.7680	±20	12.5	-40 ~+85	50
YN36K00000S100	36.0000	±30	12.5	-40 ~+85	50
YN36K00000S101	36.0000	±10	12.5	-40 ~+85	50
YN36K00000S102	36.0000	±20	12.5	-40 ~+85	50
YN38K00000S100	38.0000	±30	12.5	-40 ~+85	50
YN38K40000S100	38.4000	±30	12.5	-40 ~+85	50
YN40K00000S100	40.0000	±30	12.5	-40 ~+85	50
YN44K10000S100	44.1000	±30	12.5	-40 ~+85	50
YN60K00000S100	60.0000	±30	12.5	-40 ~+85	50

MAIN ELECTRICAL PARAMETERS - Ta = 25°C

NEXTGEN PART CODE	FREQUENCY RANGE	FREQUENCY TOLERANCE	LOAD CAPACITANCE	OPERATING TEMPERATURE	ESR MAX.
	KHz	ppm	pF	°C	KΩ
YN60K00000S101	60.0000	±10	12.5	-40 ~+85	50
YN60K00000S102	60.0000	±20	12.5	-40 ~+85	50
YN65K60000S100	65.6000	±30	12.5	-40 ~+85	50
YN68K50000S100	68.5000	±30	12.5	-40 ~+85	50
YN75K00000S100	75.0000	±30	12.5	-40 ~+85	50
YN76K80000S100	76.8000	±30	12.5	-40 ~+85	50
YN77K50000S100	77.5000	±30	12.5	-40 ~+85	50
YN77K50300S100	77.5030	±30	12.5	-40 ~+85	50
YN77K50300S101	77.5030	±10	12.5	-40 ~+85	50
YN77K50300S102	77.5030	±20	12.5	-40 ~+85	50
YN82K31500S100	82.3150	±30	12.5	-40 ~+85	50
YN96K00000S100	96.0000	±30	12.5	-40 ~+85	50
YN100K0000S100	100.000	±30	12.5	-40 ~+85	50
YN100K0000S101	100.000	±10	12.5	-40 ~+85	50
YN100K0000S102	100.000	±20	12.5	-40 ~+85	50
YN102K4000S100	102.400	±30	12.5	-40 ~+85	50
YN125K0000S100	125.000	±30	12.5	-40 ~+85	50
YN153K6000S100	153.600	±30	12.5	-40 ~+85	50
YN153K6000S102	153.600	±20	12.5	-40 ~+85	50

TEST STANDARD

General Electrical Characteristics And Visual testing

- LOT CLASSIFICATION : If The Quantity Is 1000pcs Or More, 1000 PCS Is One Lot
- Sampling Test Method : MIL-STD-105E G-II
- Test Level
- High Level Defect : AQL 0.065% [200 Pcs]
- Medium Level Defect : AQL 0.25% [50 Pcs]
- Low Level Defect :AQL 0.4% [32 Pcs]

- Defect Classification:

- High Level:

@No Frequency; @Mixing; @Leak Defect

- Medium Level - Electrical Characteristic Defect :

@Frequency; @Oscillation; @Electrical Current; @Other Electrical Characteristics Defect

- Visual : @Marking; @Welding; @Leads ; @Other Visual Defect

Testing Method And Its Standard Can Be Modified Depending On The Customer's Request

Equivalent Circuits

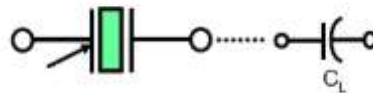
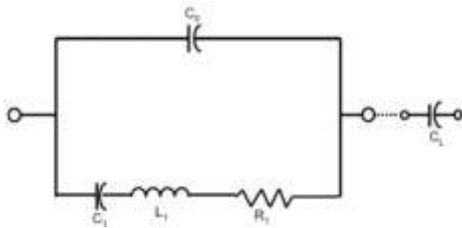

Symbol for crystal unit

EXEMPTION RULE

- SMD Tuning Fork Crystal series contain Pb chemical substance where solder material is over limitation. The location see at below drawing, The solder purpose is base connected with chip crystal blank.

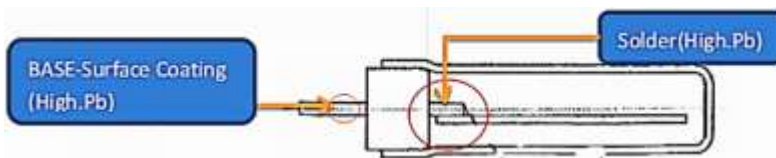

- Below statement is that exemption rule: Lead in high melting temperature type solders (i.e. lead-based alloys containing 85 % by weight or more lead).

CAUTION

In Order To Maintain Quality. Without Change In Characteristics Of The crystal Units. Please Follow Below

Recommendation

Shock

All Crystal Units Have A Thin Crystal Blanks Within If It Is Dropped Above The Recommended Dropping Height (500mm) The Specific Characteristics And Appearance Can Be Changed Please Pay Special Attention To External Shock

Environmental

1. Crystal Units' Frequency Can Be Changed Due To Surrounding Temperature If It Is Stored Next To A High Temperature Heater (Above+85°C) Or Below 40°C. And A Strong Light Source For Long Period Of Time. The Electrical Characteristics Can Be Changed It Is Suggested That These Environment Be Avoided
2. If The Unit Is Placed In A Humid Environment. Lead Terminal Can Be Damaged: Therefore. Do Not Store The Crystal Units In A Humid Environment
3. Crystal unit Has Vibrating Characteristics If It Is Placed Where Vibration Exists The Operating Characteristics Can Be Altered; Therefore This Environment Should Be Avoided

Leads

1. After Soldering Crystal Units Into A PCB Impacting The Unit From The top, bottom Left Or Right Side Of The Unit Can Shatter The Glass Portion Of The Base Rendering The Unit Useless

Assembly Method

1. Correct Ultrasonic Frequency For Cleaning Should Be Less Than 20khz
2. Soldering Should Be Bone Using IEC 61760-1 OR Pb-free Products

Storage

If The Crystal Units Are Stored In Humid Or Salty Environment Appearance Can Be Changed And Solderability Can Deteriorate; Therefore avoid Storing In Such Environment Do Not Store The Crystal Unit More Than 3 Months

RELIABILITY (Mechanical And Environmental Endurance)

TEST ITEMS	TEST METHOD AND CONDITIONS	REQUIREMENTS
Vibration	<ol style="list-style-type: none"> Vibration Frequency: 10 To 55hz Vibration Amplitude: 1.5mm Cycle Time: 1~2min(10-55-10hz) Direction: X.Y.Z Duration: 2h/Each Direction (G-force: ≥5g 	Frequency Change: ±10ppm Max. Resistance Change: ± 15% RRMax
Shock	3 Times Free Drop From 75cm Height To Hard Wooden Board Of Thickness More Than 30mm.	Frequency Change: ±10ppm Max. Resistance Change: ± 15% RRMax.
Leakage	Put Crystal Units Into A Hermetic Container And Helium For 0.5-0.6. MPA and Keep It For 1h;check The Leakage By A Helium Leak Detector.	Leakage:1x10 ⁻⁸ mbar.L/S Max.
Solderability	<ol style="list-style-type: none"> Dip The Leads Into Flu X (ROJIN Methanol) For 3~5s. Dip The Leads Into 245±5°C 99% Sn Dipping Solution For 5s. 	The Dipped Part Of The Leads Should Have 95% SN Coating.
Soldering Heat Resistance Test	<ol style="list-style-type: none"> Perform Electrical Characteristics Test Before Starting This Procedure. Dip The Leads Into Flux(Rojin Methanol) 5±0.5s. Dip The Leads Into 260±5°C 99% Sn Dipping Solution For 5s. Take The Unit Out ,Store At Room Temper For 30s Then Measure The Electrical Characteristics. 	Should Pass Sealing And Visual Test. Frequency Change: ±10ppm Max.
Leak Test	Use Helium Leak Detector. Bombing Pressure:5kg/Cm ² Bombing Time: 2 Hours Leak Should Be Less Than 1e-8 Atm. Cc/Sec.	Gas Or Air Should Not Be Detected.

RELIABILITY (Mechanical And Environmental Endurance)

TEST ITEMS	TEST METHOD AND CONDITIONS	REQUIREMENTS
High Temperature Endurance	The Crystal Units Shall Be Put In Somewhere For 500 Hours At Temperature Of 125°C ±5°C ,Then Keep It For 1 To 2 Hours Under Room Temperature.	Frequency Change: ±10ppm Max. Resistance Change: ± 15%RRmax.
Low Temperature Endurance	The Crystal Units Shall Be Put In Somewhere For 500 Hours At Temperature Of -40°C ,Then Keep It For 1 To 2 Hours Under Room.	Frequency Change: ±10ppm Max. Resistance Change: ± 15% RRMax
Humidity Endurance	Somewhere At 40°C ±5°C In Relative Humidity Of 90%~95% For 72 Hours, Then Keep It For One Or Two Hours Under Room Temperature	Frequency Change: ±10ppm Max. Resistance Change: ± 15% RRMax
Temperature Cycle	Temperature Shift From Low(-40°C) To High(100°C,keep 30 Minutes),satisfy High(100°C) To Low(-40°C ,Keep 30 Minutes),then Go Up To Room Temperature For 10 Cycles.	Frequency Change: ±10ppm Max. Resistance Change: ± 15% RRMax
Lead Tensibly	<ol style="list-style-type: none"> 1. Fix The Unit. 2. Apply 2lb Of Weight Axis To The Leads. 3. (Time:5s 	Should Pass Sealing And Visual Test.
Lead Bending	<ol style="list-style-type: none"> 1. Attach 1lb Of Weight To Each Of The Leads. 2. Bending Angle:90° (from The Normal Position To 45°oppostte Direction) 3. Bending Time:3s(each Direction) Number Of Bending:2times 4. Number Of Bending:2times 	Should Pass Sealing And Visual Test.
Marking Erase	Submerge The Unit Into Ipa [isopropyl Alcohol] Solution For 10minutes And Brush The Marking 10 Times With A Tooth Brush.	Marking Should Not Be Erased.

SUGGESTED REFLOW PROFILE (For Reference No. JEDEC J-STD-020D)

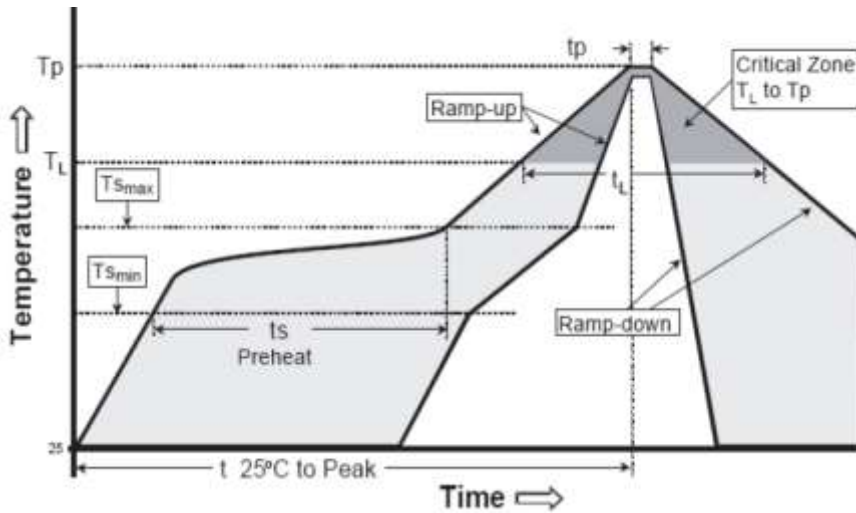

PROFILE FEATURE		PB-FREE ASSEMBLY
Average Ramp-up Rate (Ts Max to Tp)		3°C/second Max
Preheat	Temperature Min (Ts Min.)	125°C
	Temperature Max (Ts Max.)	200°C
	Time (ts Min. to ts Max.)	60 ~ 180 seconds
Time maintained above	Temperature (Tl)	217°C
	Time (tL)	60 ~ 150 seconds
Peak/Classification Temperature (Tp)		260 °C
Time within 5°C of actual Peak Temperature (tp)		20 ~ 40 seconds
Ramp-down rate		6 °C /Second Max.
Time 25 °C to Peak Temperature		8 minutes Max.
Suggest reflow times		3 Times Max.

REEL AND TAPE DIMENSION (Unit: mm)

All Devices are packed in accordance with EIA standard RS-481-2 and specifications, 3000pcs/Reel

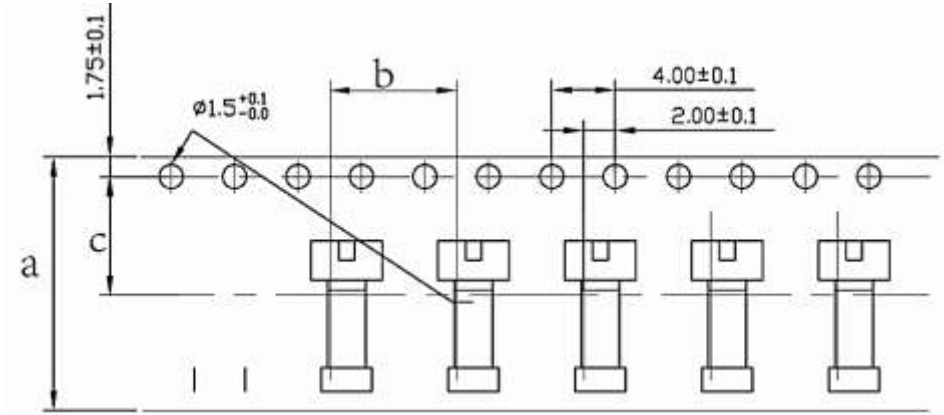

Symbol	a	b	c
Dimension	16.0	8.0	7.5

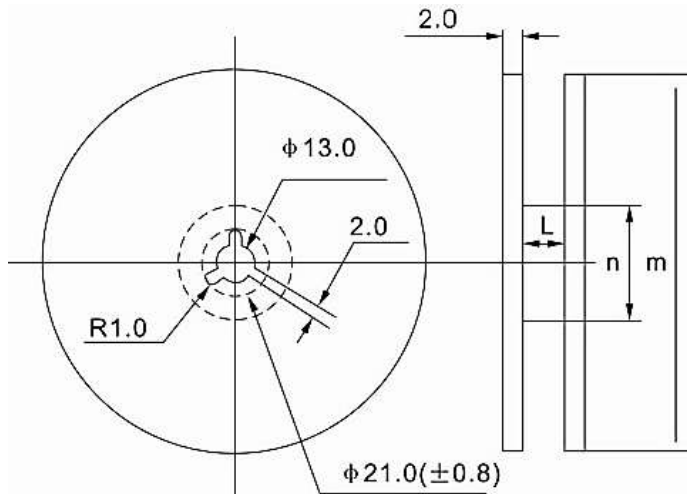

Symbol	φm	φn	L	Carrier tape size
Dimension	330±3	80 Min.	17.5	16

IMPORTANT NOTES AND DISCLAIMER

1. **ROHS COMPLIANCE:** The levels of RoHS restricted materials in this product are below the maximum concentration values (also referred to as the threshold limits) permitted for such substances, or are used in an exempted application, in accordance with EU RoHS Directive (EU) 2015/863 EC (RoHS3). RoHS Test Report for this product can be obtained at Download Center.
2. **REACH COMPLIANCE:** REACH substances of high concern (SVHCs) information is available for this product. Since the European Chemical Agency (ECHA) has published notice of their intent to frequently revise the SVHC listing for the foreseeable future, REACH Test Report for this product can be obtained at Download Center.
3. All Product parametric performance is indicated in the Electrical Characteristics for the listed herein test conditions, unless otherwise noted. Product performance may not be indicated by the Electrical Characteristics if operated under different conditions.
4. NextGen Component, Inc (*NextGen*) reserves the right to make changes to this document and its products and specifications at any time without notice. Customers should obtain and confirm the latest product information and specifications before final design, purchase or use.
5. *NextGen* makes no warranty, representation or guarantee regarding the suitability of its products for any particular purpose, not does *NextGen* assume any liability for application assistance or customer product design.
6. *NextGen* does not warrant or accept any liability with products which are purchased or used for any unintended or unauthorized application. No license is granted by implication or otherwise under any intellectual property rights of NextGen.
7. *NextGen* products are not authorized for use as critical components in life support devices or systems without express written approval by *NextGen*.
8. *NextGen* requires that customers first obtain an RMA (Returned Merchandise Authorization) number prior to returning any products. Returns must be made within 30 days of the date of invoice, be in the original packaging, unused and like-new condition. At the time of quoting or purchasing, a product may say that it is Non-Cancelable/ Non-Returnable (NCNR). These products are not returnable and not refundable.