



SPECIFICATION SHEET NO.	S0123 – RB50M00000L515	
ORIGINAL MFG/PART NO.	TGS Crystals/CO851DGI05 BLF-50M0000	
NEXTGEN PART CODE	RB50M00000L515	Indicate This Code For RFQ Order
DATE	Jan. 23, 2025	
REVISION	A2	Updated With Most Recent Data
DESCRIPTION AND MAIN PARBMETRICS	<p>MHz Thru-Hole Crystal Oscillator Half-Size/8 Pin, RB series, Dimension L12.7*W12.7*H5.08mm 50.000MHz, Supply Voltage 5.0V, Tolerance ±30ppm, Symmetry 45/55; Operating Temp. Range -40°C ~+85°C, Output Waveform HCMOS, Load 50pF, Tristate Via Pin 1 Package in Tube, 40pcs/Tube REACH/RoHS/RoHS III compliant</p>	
CUSTOMER		
CUSTOMER PART NUMBER		
CROSS REF. PART NUMBER		
MEMO		

VENDOR APPROVE		
Issued/Checked/Approved		 
Effective Date: Jan. 23, 2025		

CUSTOMER APPROVE	
Date:	

MAIN FEATURE

- MHz Thru-hole Crystal Oscillator, Half-Size/8 Pin Case
- Dimension L12.7*W12.7*H5.08mm
- Industry-standard
- Hermetically Sealed Package For Reliability
- Tristate Function – Enable/Disable or Tri-State(Output Enable) Via Pin 1
- Cross More Competitor's Part
- REACH/RoHS/RoHS III Compliant



Image shown is a representation only. Exact specifications should be obtained from the product dimension.

APPLICATION

- Wireless Devices
- Internet Of Things (IoT) Devices
- Ethernet/Gigabit Ethernet
- Audio, Video, Gaming Products
- Micro Base Station



ELECTRICAL CHARACTERISTICS

- See Page 6 ~ Page 26 For Different Part Code.
- All Products Parameters are Subject To NextGen Components' Final Confirmation.

HOW TO ORDER

- Please Follow Up Part Code Guide And Indicate NextGen Part Code RB50M00000L515 For RFQ and Order.

PART CODE GUIDE

RFQ
[Request For Quotation](#)

CODE	NAME	KEY SPECIFICATION OPTION
RB	Series Code	MHz Thru-Hole Crystal Oscillator Half-Size/8 Pin Dimension L12.7*W12.7*H5.08mm
50M0	Frequency Range Code	50M0: 50.0MHz or Custom Frequency Range
0000L	Internal Control Code	Letter A~Z, a~z or Digits (0~9)
515	Parameters Code	Special Parameters Code Letter A~Z, a~z or Digits (1-9)
XX	Special/Custom Parameters Code	Blank: N/A XX: Letter A~Z, a~z or Digits (0~9) for Special/Custom Parameters

DIMENSION (Unit: mm)

Top View

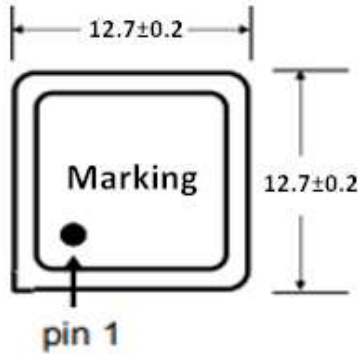

Marking:

Standard

Side View

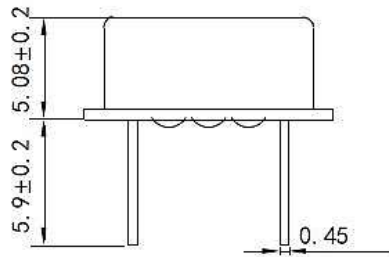

Bottom View

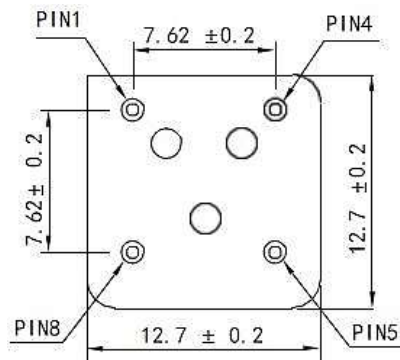

Pin Function

- # 1 Tristate Enable Via #1
- # 4 Ground
- # 5 Output
- # 8 VDD

CIRCUIT PRINCIPLE – For Reference

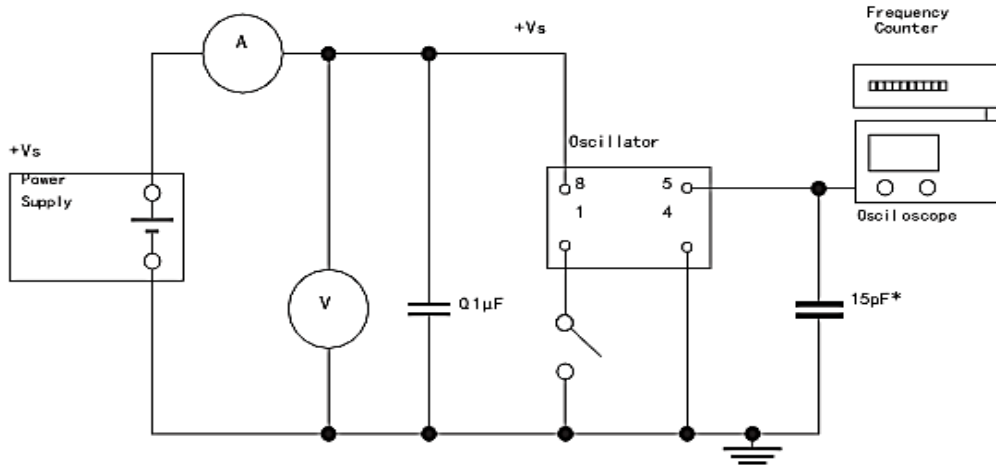

WAVFORM CONDITIONS

- Waveform measurement system should have a Min bandwidth of times the frequency being tested

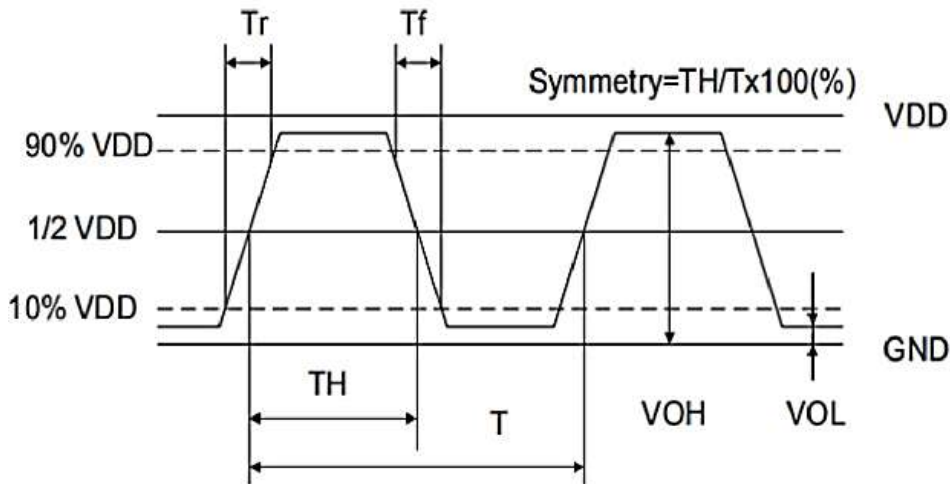

GENERBL SPECIFICATION

PARAMETER	SYMBOL	VALUE			UNIT	CONDITION
		MIN.	TYPE	MAX.		
Frequency Range	F0	0.5		160.0	MHz	Please specify
Supply Voltage		1.8, 2.5, 3.3, 5.0			V	Please specify
Frequency Tolerance	$\Delta F/F0$	± 20	-	± 50	ppm	at 25°C $\pm 10^\circ\text{C}$
Tristate Function		Disable or Tri-State (Output Enable) Via Pin 1				Please specify
Operating Temp. Range	TOPR	-40	-	+85	°C	
Storage Temp. Range	TSTG	-55	-	+125	°C	
Symmetry	%	45		55		Max.@(1/2 VDC)
Output	VOH	90%			V	V _{DD} (Min.)/2.4V
	VOL			10%	V	V _{DD} (Max.)/0.4V
	Load	15, 30, 50			pF	Please specify
Output Waveform		TTL, HCMOS				Please specify
Startup Time				5	ms	
Supply Current		30		80	mA	See Table 1
Rise/ Fall time				10	ns	@ 0.5-4.5 V _{DC}
Phase Jitter	ps	Standard				
Aging per year	Fa	-5	-	+5	ppm	

Table 1

FREQUENCY RANGE	SUPPLY CURRENT
1MHz ≤ Frequency < 40MHz	30 mA
40MHz ≤ Frequency < 80MHz	60 mA
80MHz ≤ Frequency < 160MHz	80 mA

ELECTRICAL PARAMETERS – FOR DIFFERENT PART CODE- Ta = 25°C

PART CODE	FREQUENCY	SUPPLY	FREQUENCY	OUTPUT	OUTLOAD	TRISTATE FUNCTION
	Range	VOLTAGE	Tolerance	WAVEFORM		
	MHz	V	ppm		pF	
RB500K0000L311	0.500000	3.3	±50	HCMOS	15	Tri-State (Output Enable)
RB500K0000L313	0.500000	3.3	±50	HCMOS	30	Tri-State (Output Enable)
RB500K0000L315	0.500000	3.3	±50	HCMOS	50	Tri-State (Output Enable)
RB500K0000L501	0.500000	5.0	±30	HCMOS	15	Enable/Disable
RB500K0000L511	0.500000	5.0	±50	HCMOS	15	Tri-State (Output Enable)
RB500K0000L100	0.500000	5.0	±50	HCMOS	15	Enable/Disable
RB500K0000L513	0.500000	5.0	±50	HCMOS	30	Tri-State (Output Enable)
RB500K0000L515	0.500000	5.0	±50	HCMOS	50	Tri-State (Output Enable)
RB1M000000L311	1.000000	3.3	±50	HCMOS	15	Tri-State (Output Enable)
RB1M000000L313	1.000000	3.3	±50	HCMOS	30	Tri-State (Output Enable)
RB1M000000L315	1.000000	3.3	±50	HCMOS	50	Tri-State (Output Enable)
RB1M000000L511	1.000000	5.0	±50	HCMOS	15	Tri-State (Output Enable)
RB1M000000L513	1.000000	5.0	±50	HCMOS	30	Tri-State (Output Enable)
RB1M000000L515	1.000000	5.0	±50	HCMOS	50	Tri-State (Output Enable)
RB1M228800L311	1.228800	3.3	±50	HCMOS	15	Tri-State (Output Enable)
RB1M228800L313	1.228800	3.3	±50	HCMOS	30	Tri-State (Output Enable)
RB1M228800L315	1.228800	3.3	±50	HCMOS	50	Tri-State (Output Enable)
RB1M228800L511	1.228800	5.0	±50	HCMOS	15	Tri-State (Output Enable)
RB1M228800L513	1.228800	5.0	±50	HCMOS	30	Tri-State (Output Enable)
RB1M228800L515	1.228800	5.0	±50	HCMOS	50	Tri-State (Output Enable)

ELECTRICAL PARAMETERS – FOR DIFFERENT PART CODE- Ta = 25°C

PART CODE	FREQUENCY	SUPPLY	FREQUENCY	OUTPUT	OUTLOAD	TRISTATE FUNCTION
	Range	VOLTAGE	Tolerance	WAVEFORM		
	MHz	V	ppm		pF	
RB1M544000L311	1.544000	3.3	±50	HCMOS	15	Tri-State (Output Enable)
RB1M544000L313	1.544000	3.3	±50	HCMOS	30	Tri-State (Output Enable)
RB1M544000L315	1.544000	3.3	±50	HCMOS	50	Tri-State (Output Enable)
RB1M843200L001	1.843200	3.3	±50	TTL	15	Enable/Disable
RB1M843200L311	1.843200	3.3	±50	HCMOS	15	Tri-State (Output Enable)
RB1M843200L313	1.843200	3.3	±50	HCMOS	30	Tri-State (Output Enable)
RB1M843200L315	1.843200	3.3	±50	HCMOS	50	Tri-State (Output Enable)
RB1M843200L501	1.843200	5.0	±50	HCMOS	15	Enable/Disable
RB1M843200L511	1.843200	5.0	±50	HCMOS	15	Tri-State (Output Enable)
RB1M843200L513	1.843200	5.0	±50	HCMOS	30	Tri-State (Output Enable)
RB1M843200L515	1.843200	5.0	±30	HCMOS	50	Tri-State (Output Enable)
RB1M843200L100	1.843200	5.0	±50	HCMOS	50	Tri-State (Output Enable)
RB2M000000L103	2.000000	5.0	±50	HCMOS	15	Enable/Disable
RB2M048000L001	2.048000	5.0	±50	TTL	15	Enable/Disable
RB2M048000L311	2.048000	3.3	±50	HCMOS	15	Tri-State (Output Enable)
RB2M048000L313	2.048000	3.3	±50	HCMOS	30	Tri-State (Output Enable)
RB2M048000L315	2.048000	3.3	±50	HCMOS	50	Tri-State (Output Enable)
RB2M048000L511	2.048000	5.0	±50	HCMOS	15	Tri-State (Output Enable)
RB2M048000L513	2.048000	5.0	±50	HCMOS	30	Tri-State (Output Enable)
RB2M048000L515	2.048000	5.0	±30	HCMOS	50	Tri-State (Output Enable)

ELECTRICAL PARAMETERS – FOR DIFFERENT PART CODE- Ta = 25°C

PART CODE	FREQUENCY	SUPPLY	FREQUENCY	OUTPUT	OUTLOAD	TRISTATE FUNCTION
	Range	VOLTAGE	Tolerance	WAVEFORM		
	MHz	V	ppm		pF	
RB2M457600L100	2.457600	5.0	±50	HCMOS	50	Tri-State (Output Enable)
RB2M457600L311	2.457600	3.3	±50	HCMOS	15	Tri-State (Output Enable)
RB2M457600L313	2.457600	3.3	±50	HCMOS	30	Tri-State (Output Enable)
RB2M457600L315	2.457600	3.3	±50	HCMOS	50	Tri-State (Output Enable)
RB2M457600L511	2.457600	5.0	±50	HCMOS	15	Tri-State (Output Enable)
RB2M457600L513	2.457600	5.0	±50	HCMOS	30	Tri-State (Output Enable)
RB2M457600L515	2.457600	5.0	±30	HCMOS	50	Tri-State (Output Enable)
RB3M072000L311	3.072000	3.3	±50	HCMOS	15	Tri-State (Output Enable)
RB3M072000L313	3.072000	3.3	±50	HCMOS	30	Tri-State (Output Enable)
RB3M072000L315	3.072000	3.3	±50	HCMOS	50	Tri-State (Output Enable)
RB3M072000L511	3.072000	5.0	±50	HCMOS	15	Tri-State (Output Enable)
RB3M072000L513	3.072000	5.0	±50	HCMOS	30	Tri-State (Output Enable)
RB3M072000L515	3.072000	5.0	±30	HCMOS	50	Tri-State (Output Enable)
RB3M072000L100	3.072000	5.0	±50	HCMOS	50	Tri-State (Output Enable)
RB3M579545L311	3.579545	3.3	±50	HCMOS	15	Tri-State (Output Enable)
RB3M579545L313	3.579545	3.3	±50	HCMOS	30	Tri-State (Output Enable)
RB3M579545L315	3.579545	3.3	±50	HCMOS	50	Tri-State (Output Enable)
RB3M579545L511	3.579545	5.0	±50	HCMOS	15	Tri-State (Output Enable)
RB3M579545L513	3.579545	5.0	±50	HCMOS	30	Tri-State (Output Enable)
RB3M579545L515	3.579545	5.0	±50	HCMOS	50	Tri-State (Output Enable)

ELECTRICAL PARAMETERS – FOR DIFFERENT PART CODE- Ta = 25°C

PART CODE	FREQUENCY	SUPPLY	FREQUENCY	OUTPUT	OUTLOAD	TRISTATE FUNCTION
	Range	VOLTAGE	Tolerance	WAVEFORM		
	MHz	V	ppm		pF	
RB3M686400L100	3.686400	5.0	±50	HCMOS	50	Tri-State (Output Enable)
RB3M686400L311	3.686400	3.3	±50	HCMOS	15	Tri-State (Output Enable)
RB3M686400L313	3.686400	3.3	±50	HCMOS	30	Tri-State (Output Enable)
RB3M686400L315	3.686400	3.3	±50	HCMOS	50	Tri-State (Output Enable)
RB3M686400L511	3.686400	5.0	±50	HCMOS	15	Tri-State (Output Enable)
RB3M686400L513	3.686400	5.0	±50	HCMOS	30	Tri-State (Output Enable)
RB3M686400L515	3.686400	5.0	±30	HCMOS	50	Tri-State (Output Enable)
RB4M000000L100	4.000000	5.0	±50	HCMOS	50	Tri-State (Output Enable)
RB4M000000L311	4.000000	3.3	±50	HCMOS	15	Tri-State (Output Enable)
RB4M000000L313	4.000000	3.3	±50	HCMOS	30	Tri-State (Output Enable)
RB4M000000L315	4.000000	3.3	±50	HCMOS	50	Tri-State (Output Enable)
RB4M000000L501	4.000000	5.0	±50	HCMOS	15	Enable/Disable
RB4M000000L101	4.000000	5.0	±50	HCMOS	15	Enable/Disable
RB4M000000L511	4.000000	5.0	±30	HCMOS	15	Tri-State (Output Enable)
RB4M000000L513	4.000000	5.0	±50	HCMOS	30	Tri-State (Output Enable)
RB4M000000L515	4.000000	5.0	±30	HCMOS	50	Tri-State (Output Enable)
RB4M096000L100	4.096000	5.0	±50	HCMOS	50	Tri-State (Output Enable)
RB4M096000L311	4.096000	3.3	±50	HCMOS	15	Tri-State (Output Enable)
RB4M096000L313	4.096000	3.3	±50	HCMOS	30	Tri-State (Output Enable)
RB4M096000L315	4.096000	3.3	±50	HCMOS	50	Tri-State (Output Enable)

ELECTRICAL PARAMETERS – FOR DIFFERENT PART CODE- Ta = 25°C

PART CODE	FREQUENCY	SUPPLY	FREQUENCY	OUTPUT	OUTLOAD	TRISTATE FUNCTION
	Range	VOLTAGE	Tolerance	WAVEFORM		
	MHz	V	ppm		pF	
RB4M096000L511	4.096000	5.0	±50	HCMOS	15	Tri-State (Output Enable)
RB4M096000L513	4.096000	5.0	±50	HCMOS	30	Tri-State (Output Enable)
RB4M096000L515	4.096000	5.0	±30	HCMOS	50	Tri-State (Output Enable)
RB4M915200L100	4.915200	5.0	±50	HCMOS	50	Tri-State (Output Enable)
RB4M915200L101	4.915200	3.3	±50	TTL	15	Tri-State (Output Enable)
RB4M915200L311	4.915200	3.3	±30	HCMOS	15	Tri-State (Output Enable)
RB4M915200L313	4.915200	3.3	±50	HCMOS	30	Tri-State (Output Enable)
RB4M915200L315	4.915200	3.3	±50	HCMOS	50	Tri-State (Output Enable)
RB4M915200L511	4.915200	5.0	±50	HCMOS	15	Tri-State (Output Enable)
RB4M915200L513	4.915200	5.0	±50	HCMOS	30	Tri-State (Output Enable)
RB4M915200L515	4.915200	5.0	±30	HCMOS	50	Tri-State (Output Enable)
RB5M000000L311	5.000000	3.3	±50	HCMOS	15	Tri-State (Output Enable)
RB5M000000L313	5.000000	3.3	±50	HCMOS	30	Tri-State (Output Enable)
RB5M000000L315	5.000000	3.3	±50	HCMOS	50	Tri-State (Output Enable)
RB5M000000L511	5.000000	5.0	±50	HCMOS	15	Tri-State (Output Enable)
RB5M000000L513	5.000000	5.0	±50	HCMOS	30	Tri-State (Output Enable)
RB5M000000L515	5.000000	5.0	±50	HCMOS	50	Tri-State (Output Enable)
RB6M000000L100	6.000000	5.0	±50	HCMOS	50	Tri-State (Output Enable)
RB6M000000L311	6.000000	3.3	±50	HCMOS	15	Tri-State (Output Enable)
RB6M000000L313	6.000000	3.3	±50	HCMOS	30	Tri-State (Output Enable)

ELECTRICAL PARAMETERS – FOR DIFFERENT PART CODE- Ta = 25°C

PART CODE	FREQUENCY	SUPPLY	FREQUENCY	OUTPUT	OUTLOAD	TRISTATE FUNCTION
	Range	VOLTAGE	Tolerance	WAVEFORM		
	MHz	V	ppm		pF	
RB6M000000L315	6.000000	3.3	±50	HCMOS	50	Tri-State (Output Enable)
RB6M000000L511	6.000000	5.0	±50	HCMOS	15	Tri-State (Output Enable)
RB6M000000L513	6.000000	5.0	±50	HCMOS	30	Tri-State (Output Enable)
RB6M000000L515	6.000000	5.0	±30	HCMOS	50	Tri-State (Output Enable)
RB6M144000L311	6.144400	3.3	±50	HCMOS	15	Tri-State (Output Enable)
RB6M144000L313	6.144400	3.3	±50	HCMOS	30	Tri-State (Output Enable)
RB6M144000L315	6.144400	3.3	±50	HCMOS	50	Tri-State (Output Enable)
RB6M144000L511	6.144400	5.0	±50	HCMOS	15	Tri-State (Output Enable)
RB6M144000L513	6.144400	5.0	±50	HCMOS	30	Tri-State (Output Enable)
RB6M144000L515	6.144400	5.0	±50	HCMOS	50	Tri-State (Output Enable)
RB7M372800L100	7.372800	5.0	±50	HCMOS	50	Tri-State (Output Enable)
RB7M372800L101	7.372800	5.0	±50	HCMOS	15	Enable/Disable
RB7M372800L103	7.372800	5.0	±50	HCMOS	15	Tri-State (Output Enable)
RB7M372800L311	7.372800	3.3	±50	HCMOS	15	Tri-State (Output Enable)
RB7M372800L313	7.372800	3.3	±50	HCMOS	30	Tri-State (Output Enable)
RB7M372800L315	7.372800	3.3	±50	HCMOS	50	Tri-State (Output Enable)
RB7M372800L501	7.372800	5.0	±30	HCMOS	15	Enable/Disable
RB7M372800L511	7.372800	5.0	±30	HCMOS	15	Tri-State (Output Enable)
RB7M372800L513	7.372800	5.0	±50	HCMOS	30	Tri-State (Output Enable)
RB7M372800L515	7.372800	5.0	±30	HCMOS	50	Tri-State (Output Enable)

ELECTRICAL PARAMETERS – FOR DIFFERENT PART CODE- Ta = 25°C

PART CODE	FREQUENCY	SUPPLY	FREQUENCY	OUTPUT	OUTLOAD	TRISTATE FUNCTION
	Range	VOLTAGE	Tolerance	WAVEFORM		
	MHz	V	ppm		pF	
RB8M000000L100	8.000000	5.0	±50	HCMOS	50	Tri-State (Output Enable)
RB8M000000L102	8.000000	5.0	±50	HCMOS	30	Enable/Disable
RB8M000000L103	8.000000	5.0	±30	HCMOS	50	Tri-State (Output Enable)
RB8M000000L104	8.000000	5.0	±50	HCMOS	15	Enable/Disable
RB8M000000L311	8.000000	3.3	±50	HCMOS	15	Tri-State (Output Enable)
RB8M000000L313	8.000000	3.3	±50	HCMOS	30	Tri-State (Output Enable)
RB8M000000L315	8.000000	3.3	±50	HCMOS	50	Tri-State (Output Enable)
RB8M000000L501	8.000000	5.0	±30	HCMOS	15	Enable/Disable
RB8M000000L503	8.000000	5.0	±30	HCMOS	30	Enable/Disable
RB8M000000L511	8.000000	5.0	±30	HCMOS	15	Tri-State (Output Enable)
RB8M000000L513	8.000000	5.0	±50	HCMOS	30	Tri-State (Output Enable)
RB8M000000L515	8.000000	5.0	±25	HCMOS	50	Tri-State (Output Enable)
RB9M375000L100	9.375000	3.3	±50	TTL	15	Enable/Disable
RB9M375000L311	9.375000	3.3	±50	HCMOS	15	Tri-State (Output Enable)
RB9M375000L313	9.375000	3.3	±50	HCMOS	30	Tri-State (Output Enable)
RB9M375000L315	9.375000	3.3	±50	HCMOS	50	Tri-State (Output Enable)
RB9M375000L511	9.375000	5.0	±50	HCMOS	15	Tri-State (Output Enable)
RB9M375000L513	9.375000	5.0	±50	HCMOS	30	Tri-State (Output Enable)
RB9M375000L515	9.375000	5.0	±50	HCMOS	50	Tri-State (Output Enable)
RB9M830400L100	9.830400	5.0	±50	HCMOS	50	Tri-State (Output Enable)

ELECTRICAL PARAMETERS – FOR DIFFERENT PART CODE- Ta = 25°C

PART CODE	FREQUENCY	SUPPLY	FREQUENCY	OUTPUT	OUTLOAD	TRISTATE FUNCTION
	Range	VOLTAGE	Tolerance	WAVEFORM		
	MHz	V	ppm		pF	
RB9M830400L311	9.830400	3.3	±50	HCMOS	15	Tri-State (Output Enable)
RB9M830400L313	9.830400	3.3	±50	HCMOS	30	Tri-State (Output Enable)
RB9M830400L315	9.830400	3.3	±50	HCMOS	50	Tri-State (Output Enable)
RB9M830400L511	9.830400	5.0	±50	HCMOS	15	Tri-State (Output Enable)
RB9M830400L513	9.830400	5.0	±50	HCMOS	30	Tri-State (Output Enable)
RB9M830400L515	9.830400	5.0	±30	HCMOS	50	Tri-State (Output Enable)
RB10M00000L100	10.000000	5.0	±50	HCMOS	50	Tri-State (Output Enable)
RB10M00000L101	10.000000	5.0	±50	HCMOS	50	Enable/Disable
RB10M00000L311	10.000000	3.3	±50	HCMOS	15	Tri-State (Output Enable)
RB10M00000L313	10.000000	3.3	±50	HCMOS	30	Tri-State (Output Enable)
RB10M00000L315	10.000000	3.3	±50	HCMOS	50	Tri-State (Output Enable)
RB10M00000L505	10.000000	5.0	±30	HCMOS	50	Enable/Disable
RB10M00000L511	10.000000	5.0	±50	HCMOS	15	Tri-State (Output Enable)
RB10M00000L513	10.000000	5.0	±50	HCMOS	30	Tri-State (Output Enable)
RB10M00000L515	10.000000	5.0	±30	HCMOS	50	Tri-State (Output Enable)
RB11M05920L311	11.059200	3.3	±50	HCMOS	15	Tri-State (Output Enable)
RB11M05920L313	11.059200	3.3	±50	HCMOS	30	Tri-State (Output Enable)
RB11M05920L315	11.059200	3.3	±50	HCMOS	50	Tri-State (Output Enable)
RB11M05920L511	11.059200	5.0	±50	HCMOS	15	Tri-State (Output Enable)
RB11M05920L513	11.059200	5.0	±50	HCMOS	30	Tri-State (Output Enable)

ELECTRICAL PARAMETERS – FOR DIFFERENT PART CODE- Ta = 25°C

PART CODE	FREQUENCY	SUPPLY	FREQUENCY	OUTPUT	OUTLOAD	TRISTATE FUNCTION
	Range	VOLTAGE	Tolerance	WAVEFORM		
	MHz	V	ppm		pF	
RB11M05920L515	11.059200	5.0	±50	HCMOS	50	Tri-State (Output Enable)
RB12M00000L100	12.000000	5.0	±50	HCMOS	50	Tri-State (Output Enable)
RB12M00000L311	12.000000	3.3	±50	HCMOS	15	Tri-State (Output Enable)
RB12M00000L313	12.000000	3.3	±50	HCMOS	30	Tri-State (Output Enable)
RB12M00000L315	12.000000	3.3	±50	HCMOS	50	Tri-State (Output Enable)
RB12M00000L511	12.000000	5.0	±50	HCMOS	10	Tri-State (Output Enable)
RB12M00000L513	12.000000	5.0	±50	HCMOS	30	Tri-State (Output Enable)
RB12M00000L515	12.000000	5.0	±30	HCMOS	50	Tri-State (Output Enable)
RB12M28800L100	12.288000	5.0	±50	HCMOS	50	Tri-State (Output Enable)
RB12M28800L101	12.288000	5.0	±30	HCMOS	15	Tri-State (Output Enable)
RB12M28800L311	12.288000	3.3	±50	HCMOS	15	Tri-State (Output Enable)
RB12M28800L313	12.288000	3.3	±50	HCMOS	30	Tri-State (Output Enable)
RB12M28800L315	12.288000	3.3	±50	HCMOS	50	Tri-State (Output Enable)
RB12M28800L511	12.288000	5.0	±50	HCMOS	15	Tri-State (Output Enable)
RB12M28800L513	12.288000	5.0	±50	HCMOS	30	Tri-State (Output Enable)
RB12M28800L515	12.288000	5.0	±30	HCMOS	50	Tri-State (Output Enable)
RB14M31818L100	14.318180	5.0	±50	HCMOS	50	Tri-State (Output Enable)
RB14M31818L311	14.318180	3.3	±50	HCMOS	15	Tri-State (Output Enable)
RB14M31818L313	14.318180	3.3	±50	HCMOS	30	Tri-State (Output Enable)
RB14M31818L315	14.318180	3.3	±50	HCMOS	50	Tri-State (Output Enable)

ELECTRICAL PARAMETERS – FOR DIFFERENT PART CODE- Ta = 25°C

PART CODE	FREQUENCY	SUPPLY	FREQUENCY	OUTPUT	OUTLOAD	TRISTATE FUNCTION
	Range	VOLTAGE	Tolerance	WAVEFORM		
	MHz	V	ppm		pF	
RB14M31818L511	14.318180	5.0	±50	HCMOS	15	Tri-State (Output Enable)
RB14M31818L513	14.318180	5.0	±50	HCMOS	30	Tri-State (Output Enable)
RB14M31818L515	14.318180	5.0	±30	HCMOS	50	Tri-State (Output Enable)
RB14M74560L100	14.745600	5.0	±50	HCMOS	50	Tri-State (Output Enable)
RB14M74560L311	14.745600	3.3	±50	HCMOS	15	Tri-State (Output Enable)
RB14M74560L313	14.745600	3.3	±50	HCMOS	30	Tri-State (Output Enable)
RB14M74560L315	14.745600	3.3	±50	HCMOS	50	Tri-State (Output Enable)
RB14M74560L511	14.745600	5.0	±50	HCMOS	15	Tri-State (Output Enable)
RB14M74560L513	14.745600	5.0	±50	HCMOS	30	Tri-State (Output Enable)
RB14M74560L515	14.745600	5.0	±30	HCMOS	50	Tri-State (Output Enable)
RB15M00000L311	15.000000	3.3	±50	HCMOS	15	Tri-State (Output Enable)
RB15M00000L313	15.000000	3.3	±50	HCMOS	30	Tri-State (Output Enable)
RB15M00000L315	15.000000	3.3	±50	HCMOS	50	Tri-State (Output Enable)
RB15M00000L511	15.000000	5.0	±50	HCMOS	15	Tri-State (Output Enable)
RB15M00000L513	15.000000	5.0	±50	HCMOS	30	Tri-State (Output Enable)
RB15M00000L515	15.000000	5.0	±50	HCMOS	50	Tri-State (Output Enable)
RB16M00000L100	16.000000	5.0	±50	HCMOS	50	Tri-State (Output Enable)
RB16M00000L101	16.000000	5.0	±50	HCMOS	50	Enable/Disable
RB16M00000L311	16.000000	3.3	±50	HCMOS	15	Tri-State (Output Enable)
RB16M00000L313	16.000000	3.3	±50	HCMOS	30	Tri-State (Output Enable)

ELECTRICAL PARAMETERS – FOR DIFFERENT PART CODE- Ta = 25°C

PART CODE	FREQUENCY	SUPPLY	FREQUENCY	OUTPUT	OUTLOAD	TRISTATE FUNCTION
	Range	VOLTAGE	Tolerance	WAVEFORM		
	MHz	V	ppm		pF	
RB16M00000L315	16.000000	3.3	±50	HCMOS	50	Tri-State (Output Enable)
RB16M00000L505	16.000000	5.0	±30	HCMOS	50	Enable/Disable
RB16M00000L511	16.000000	5.0	±50	HCMOS	15	Tri-State (Output Enable)
RB16M00000L513	16.000000	5.0	±50	HCMOS	30	Tri-State (Output Enable)
RB16M00000L515	16.000000	5.0	±30	HCMOS	50	Tri-State (Output Enable)
RB16M25700L311	16.257000	3.3	±50	HCMOS	15	Tri-State (Output Enable)
RB16M25700L313	16.257000	3.3	±50	HCMOS	30	Tri-State (Output Enable)
RB16M25700L315	16.257000	3.3	±50	HCMOS	50	Tri-State (Output Enable)
RB16M38400L100	16.384000	5.0	±50	HCMOS	50	Tri-State (Output Enable)
RB16M38400L311	16.384000	3.3	±50	HCMOS	15	Tri-State (Output Enable)
RB16M38400L313	16.384000	3.3	±50	HCMOS	30	Tri-State (Output Enable)
RB16M38400L315	16.384000	3.3	±50	HCMOS	50	Tri-State (Output Enable)
RB16M38400L511	16.384000	5.0	±50	HCMOS	15	Tri-State (Output Enable)
RB16M38400L513	16.384000	5.0	±50	HCMOS	30	Tri-State (Output Enable)
RB16M38400L515	16.384000	5.0	±30	HCMOS	50	Tri-State (Output Enable)
RB18M00000L311	18.000000	3.3	±50	HCMOS	15	Tri-State (Output Enable)
RB18M00000L313	18.000000	3.3	±50	HCMOS	30	Tri-State (Output Enable)
RB18M00000L315	18.000000	3.3	±50	HCMOS	50	Tri-State (Output Enable)
RB18M00000L511	18.000000	5.0	±50	HCMOS	15	Tri-State (Output Enable)
RB18M00000L513	18.000000	5.0	±50	HCMOS	30	Tri-State (Output Enable)

ELECTRICAL PARAMETERS – FOR DIFFERENT PART CODE- Ta = 25°C

PART CODE	FREQUENCY	SUPPLY	FREQUENCY	OUTPUT	OUTLOAD	TRISTATE FUNCTION
	Range	VOLTAGE	Tolerance	WAVEFORM		
	MHz	V	ppm		pF	
RB18M00000L515	18.000000	5.0	±50	HCMOS	50	Tri-State (Output Enable)
RB18M43200L100	18.432000	5.0	±50	HCMOS	50	Tri-State (Output Enable)
RB18M43200L101	18.432000	5.0	±50	HCMOS	15	Enable/Disable
RB18M43200L311	18.432000	3.3	±50	HCMOS	15	Tri-State (Output Enable)
RB18M43200L313	18.432000	3.3	±50	HCMOS	30	Tri-State (Output Enable)
RB18M43200L315	18.432000	3.3	±50	HCMOS	50	Tri-State (Output Enable)
RB18M43200L511	18.432000	5.0	±50	HCMOS	15	Tri-State (Output Enable)
RB18M43200L513	18.432000	5.0	±50	HCMOS	30	Tri-State (Output Enable)
RB18M43200L515	18.432000	5.0	±30	HCMOS	50	Tri-State (Output Enable)
RB19M66080L311	19.660800	3.3	±50	HCMOS	15	Tri-State (Output Enable)
RB19M66080L313	19.660800	3.3	±50	HCMOS	30	Tri-State (Output Enable)
RB19M66080L315	19.660800	3.3	±50	HCMOS	50	Tri-State (Output Enable)
RB19M66080L511	19.660800	5.0	±50	HCMOS	15	Tri-State (Output Enable)
RB19M66080L513	19.660800	5.0	±50	HCMOS	30	Tri-State (Output Enable)
RB19M66080L515	19.660800	5.0	±50	HCMOS	50	Tri-State (Output Enable)
RB20M00000L100	20.000000	5.0	±50	HCMOS	50	Tri-State (Output Enable)
RB20M00000L311	20.000000	3.3	±50	HCMOS	15	Tri-State (Output Enable)
RB20M00000L313	20.000000	3.3	±50	HCMOS	30	Tri-State (Output Enable)
RB20M00000L315	20.000000	3.3	±50	HCMOS	50	Tri-State (Output Enable)
RB20M00000L511	20.000000	5.0	±50	HCMOS	15	Tri-State (Output Enable)

ELECTRICAL PARAMETERS – FOR DIFFERENT PART CODE- Ta = 25°C

PART CODE	FREQUENCY	SUPPLY	FREQUENCY	OUTPUT	OUTLOAD	TRISTATE FUNCTION
	Range	VOLTAGE	Tolerance	WAVEFORM		
	MHz	V	ppm		pF	
RB20M00000L513	20.000000	5.0	±50	HCMOS	30	Tri-State (Output Enable)
RB20M00000L515	20.000000	5.0	±30	HCMOS	50	Tri-State (Output Enable)
RB20M48000L001	20.480000	3.3	±50	TTL	15	Enable/Disable
RB20M48000L311	20.480000	3.3	±50	HCMOS	15	Tri-State (Output Enable)
RB20M48000L313	20.480000	3.3	±50	HCMOS	30	Tri-State (Output Enable)
RB20M48000L315	20.480000	3.3	±50	HCMOS	50	Tri-State (Output Enable)
RB20M48000L511	20.480000	5.0	±50	HCMOS	15	Tri-State (Output Enable)
RB20M48000L513	20.480000	5.0	±50	HCMOS	30	Tri-State (Output Enable)
RB20M48000L515	20.480000	5.0	±50	HCMOS	50	Tri-State (Output Enable)
RB24M00000L100	24.000000	5.0	±50	HCMOS	50	Tri-State (Output Enable)
RB24M00000L101	24.000000	5.0	±50	HCMOS	50	Enable/Disable
RB24M00000L311	24.000000	3.3	±50	HCMOS	15	Tri-State (Output Enable)
RB24M00000L313	24.000000	3.3	±50	HCMOS	30	Tri-State (Output Enable)
RB24M00000L315	24.000000	3.3	±50	HCMOS	50	Tri-State (Output Enable)
RB24M00000L505	24.000000	5.0	±30	HCMOS	50	Enable/Disable
RB24M00000L511	24.000000	5.0	±50	HCMOS	15	Tri-State (Output Enable)
RB24M00000L513	24.000000	5.0	±50	HCMOS	30	Tri-State (Output Enable)
RB24M00000L515	24.000000	5.0	±30	HCMOS	50	Tri-State (Output Enable)
RB24M57600L100	24.576000	5.0	±50	HCMOS	50	Tri-State (Output Enable)
RB24M57600L311	24.576000	3.3	±50	HCMOS	15	Tri-State (Output Enable)

ELECTRICAL PARAMETERS – FOR DIFFERENT PART CODE- Ta = 25°C

PART CODE	FREQUENCY	SUPPLY	FREQUENCY	OUTPUT	OUTLOAD	TRISTATE FUNCTION
	Range	VOLTAGE	Tolerance	WAVEFORM		
	MHz	V	ppm		pF	
RB24M57600L313	24.576000	3.3	±50	HCMOS	30	Tri-State (Output Enable)
RB24M57600L315	24.576000	3.3	±50	HCMOS	50	Tri-State (Output Enable)
RB24M57600L511	24.576000	5.0	±50	HCMOS	15	Tri-State (Output Enable)
RB24M57600L513	24.576000	5.0	±50	HCMOS	30	Tri-State (Output Enable)
RB24M57600L515	24.576000	5.0	±30	HCMOS	50	Tri-State (Output Enable)
RB25M00000L100	25.000000	5.0	±50	HCMOS	50	Tri-State (Output Enable)
RB25M00000L311	25.000000	3.3	±50	HCMOS	15	Tri-State (Output Enable)
RB25M00000L313	25.000000	3.3	±50	HCMOS	30	Tri-State (Output Enable)
RB25M00000L315	25.000000	3.3	±50	HCMOS	50	Tri-State (Output Enable)
RB25M00000L511	25.000000	5.0	±50	HCMOS	15	Tri-State (Output Enable)
RB25M00000L513	25.000000	5.0	±50	HCMOS	30	Tri-State (Output Enable)
RB25M00000L515	25.000000	5.0	±30	HCMOS	50	Tri-State (Output Enable)
RB25M17500L311	25.175000	3.3	±50	HCMOS	15	Tri-State (Output Enable)
RB25M17500L313	25.175000	3.3	±50	HCMOS	30	Tri-State (Output Enable)
RB25M17500L315	25.175000	3.3	±50	HCMOS	50	Tri-State (Output Enable)
RB26M88000L311	26.880000	3.3	±50	HCMOS	15	Tri-State (Output Enable)
RB26M88000L313	26.880000	3.3	±50	HCMOS	30	Tri-State (Output Enable)
RB26M88000L315	26.880000	3.3	±50	HCMOS	50	Tri-State (Output Enable)
RB27M00000L311	27.000000	3.3	±50	HCMOS	15	Tri-State (Output Enable)
RB27M00000L313	27.000000	3.3	±50	HCMOS	30	Tri-State (Output Enable)

ELECTRICAL PARAMETERS – FOR DIFFERENT PART CODE- Ta = 25°C

PART CODE	FREQUENCY	SUPPLY	FREQUENCY	OUTPUT	OUTLOAD	TRISTATE FUNCTION
	Range	VOLTAGE	Tolerance	WAVEFORM		
	MHz	V	ppm		pF	
RB27M0000L315	27.000000	3.3	±50	HCMOS	50	Tri-State (Output Enable)
RB27M0000L511	27.000000	5.0	±50	HCMOS	15	Tri-State (Output Enable)
RB27M0000L513	27.000000	5.0	±50	HCMOS	30	Tri-State (Output Enable)
RB27M0000L515	27.000000	5.0	±50	HCMOS	50	Tri-State (Output Enable)
RB28M0000L311	28.000000	3.3	±50	HCMOS	15	Tri-State (Output Enable)
RB28M0000L313	28.000000	3.3	±50	HCMOS	30	Tri-State (Output Enable)
RB28M0000L315	28.000000	3.3	±50	HCMOS	50	Tri-State (Output Enable)
RB28M3220L311	28.322000	3.3	±50	HCMOS	15	Tri-State (Output Enable)
RB28M3220L313	28.322000	3.3	±50	HCMOS	30	Tri-State (Output Enable)
RB28M3220L315	28.322000	3.3	±50	HCMOS	50	Tri-State (Output Enable)
RB28M3220L511	28.322000	5.0	±50	HCMOS	15	Tri-State (Output Enable)
RB28M3220L513	28.322000	5.0	±50	HCMOS	30	Tri-State (Output Enable)
RB28M3220L515	28.322000	5.0	±50	HCMOS	50	Tri-State (Output Enable)
RB29M4912L311	29.491200	3.3	±50	HCMOS	15	Tri-State (Output Enable)
RB29M4912L313	29.491200	3.3	±50	HCMOS	30	Tri-State (Output Enable)
RB29M4912L315	29.491200	3.3	±50	HCMOS	50	Tri-State (Output Enable)
RB29M4912L511	29.491200	5.0	±50	HCMOS	15	Tri-State (Output Enable)
RB29M4912L513	29.491200	5.0	±50	HCMOS	30	Tri-State (Output Enable)
RB29M4912L515	29.491200	5.0	±50	HCMOS	50	Tri-State (Output Enable)
RB30M0000L311	30.000000	3.3	±50	HCMOS	15	Tri-State (Output Enable)

ELECTRICAL PARAMETERS – FOR DIFFERENT PART CODE- Ta = 25°C

PART CODE	FREQUENCY	SUPPLY	FREQUENCY	OUTPUT	OUTLOAD	TRISTATE FUNCTION
	Range	VOLTAGE	Tolerance	WAVEFORM		
	MHz	V	ppm		pF	
RB30M00000L313	30.000000	3.3	±50	HCMOS	30	Tri-State (Output Enable)
RB30M00000L315	30.000000	3.3	±50	HCMOS	50	Tri-State (Output Enable)
RB30M00000L511	30.000000	5.0	±50	HCMOS	15	Tri-State (Output Enable)
RB30M00000L513	30.000000	5.0	±50	HCMOS	30	Tri-State (Output Enable)
RB30M00000L515	30.000000	5.0	±50	HCMOS	50	Tri-State (Output Enable)
RB32M00000L100	32.000000	5.0	±50	HCMOS	50	Tri-State (Output Enable)
RB32M00000L311	32.000000	3.3	±50	HCMOS	15	Tri-State (Output Enable)
RB32M00000L313	32.000000	3.3	±50	HCMOS	30	Tri-State (Output Enable)
RB32M00000L315	32.000000	3.3	±50	HCMOS	50	Tri-State (Output Enable)
RB32M00000L511	32.000000	5.0	±50	HCMOS	15	Tri-State (Output Enable)
RB32M00000L513	32.000000	5.0	±50	HCMOS	30	Tri-State (Output Enable)
RB32M00000L515	32.000000	5.0	±30	HCMOS	50	Tri-State (Output Enable)
RB32M76800L100	32.768000	5.0	±50	HCMOS	50	Tri-State (Output Enable)
RB32M76800L311	32.768000	3.3	±50	HCMOS	15	Tri-State (Output Enable)
RB32M76800L313	32.768000	3.3	±50	HCMOS	30	Tri-State (Output Enable)
RB32M76800L315	32.768000	3.3	±50	HCMOS	50	Tri-State (Output Enable)
RB32M76800L511	32.768000	5.0	±50	HCMOS	15	Tri-State (Output Enable)
RB32M76800L513	32.768000	5.0	±50	HCMOS	30	Tri-State (Output Enable)
RB32M76800L515	32.768000	5.0	±30	HCMOS	50	Tri-State (Output Enable)
RB33M00000L311	33.000000	3.3	±50	HCMOS	15	Tri-State (Output Enable)

ELECTRICAL PARAMETERS – FOR DIFFERENT PART CODE- Ta = 25°C

PART CODE	FREQUENCY	SUPPLY	FREQUENCY	OUTPUT	OUTLOAD	TRISTATE FUNCTION
	Range	VOLTAGE	Tolerance	WAVEFORM		
	MHz	V	ppm		pF	
RB33M00000L313	33.000000	3.3	±50	HCMOS	30	Tri-State (Output Enable)
RB33M00000L315	33.000000	3.3	±50	HCMOS	50	Tri-State (Output Enable)
RB33M00000L511	33.000000	5.0	±50	HCMOS	15	Tri-State (Output Enable)
RB33M00000L513	33.000000	5.0	±50	HCMOS	30	Tri-State (Output Enable)
RB38M00000L311	38.000000	3.3	±50	HCMOS	50	Tri-State (Output Enable)
RB38M00000L313	38.000000	3.3	±50	HCMOS	15	Tri-State (Output Enable)
RB38M00000L315	38.000000	3.3	±50	HCMOS	30	Tri-State (Output Enable)
RB40M00000L100	40.000000	5.0	±50	HCMOS	50	Tri-State (Output Enable)
RB40M00000L102	40.000000	5.0	±50	HCMOS	30	Enable/Disable
RB40M00000L311	40.000000	3.3	±50	HCMOS	15	Tri-State (Output Enable)
RB40M00000L313	40.000000	3.3	±50	HCMOS	30	Tri-State (Output Enable)
RB40M00000L315	40.000000	3.3	±50	HCMOS	50	Tri-State (Output Enable)
RB40M00000L511	40.000000	5.0	±50	HCMOS	15	Tri-State (Output Enable)
RB40M00000L513	40.000000	5.0	±50	HCMOS	30	Tri-State (Output Enable)
RB40M00000L515	40.000000	5.0	±30	HCMOS	50	Tri-State (Output Enable)
RB40M25000L311	40.250000	3.3	±50	HCMOS	15	Tri-State (Output Enable)
RB40M25000L313	40.250000	3.3	±50	HCMOS	30	Tri-State (Output Enable)
RB40M25000L315	40.250000	3.3	±50	HCMOS	50	Tri-State (Output Enable)
RB46M00000L311	46.000000	3.3	±50	HCMOS	15	Tri-State (Output Enable)
RB46M00000L313	46.000000	3.3	±50	HCMOS	30	Tri-State (Output Enable)

ELECTRICAL PARAMETERS – FOR DIFFERENT PART CODE- Ta = 25°C

PART CODE	FREQUENCY	SUPPLY	FREQUENCY	OUTPUT	OUTLOAD	TRISTATE FUNCTION
	Range	VOLTAGE	Tolerance	WAVEFORM		
	MHz	V	ppm		pF	
RB46M00000L315	46.000000	3.3	±50	HCMOS	50	Tri-State (Output Enable)
RB48M00000L100	48.000000	5.0	±50	HCMOS	50	Tri-State (Output Enable)
RB48M00000L311	48.000000	3.3	±50	HCMOS	15	Tri-State (Output Enable)
RB48M00000L313	48.000000	3.3	±50	HCMOS	30	Tri-State (Output Enable)
RB48M00000L315	48.000000	3.3	±50	HCMOS	50	Tri-State (Output Enable)
RB48M00000L511	48.000000	5.0	±50	HCMOS	15	Tri-State (Output Enable)
RB48M00000L513	48.000000	5.0	±50	HCMOS	30	Tri-State (Output Enable)
RB48M00000L515	48.000000	5.0	±30	HCMOS	50	Tri-State (Output Enable)
RB50M00000L100	50.000000	5.0	±50	HCMOS	50	Tri-State (Output Enable)
RB50M00000L101	50.000000	5.0	±50	HCMOS	50	Tri-State (Output Enable)
RB50M00000L311	50.000000	3.3	±50	HCMOS	15	Tri-State (Output Enable)
RB50M00000L313	50.000000	3.3	±50	HCMOS	30	Tri-State (Output Enable)
RB50M00000L315	50.000000	3.3	±50	HCMOS	50	Tri-State (Output Enable)
RB50M00000L511	50.000000	5.0	±50	HCMOS	15	Tri-State (Output Enable)
RB50M00000L513	50.000000	5.0	±50	HCMOS	30	Tri-State (Output Enable)
RB50M00000L515	50.000000	5.0	±30	HCMOS	50	Tri-State (Output Enable)
RB60M00000L311	60.000000	3.3	±50	HCMOS	15	Tri-State (Output Enable)
RB60M00000L313	60.000000	3.3	±50	HCMOS	30	Tri-State (Output Enable)
RB60M00000L315	60.000000	3.3	±50	HCMOS	50	Tri-State (Output Enable)
RB60M00000L511	60.000000	5.0	±50	HCMOS	15	Tri-State (Output Enable)

ELECTRICAL PARAMETERS – FOR DIFFERENT PART CODE- Ta = 25°C

PART CODE	FREQUENCY	SUPPLY	FREQUENCY	OUTPUT	OUTLOAD	TRISTATE FUNCTION
	Range	VOLTAGE	Tolerance	WAVEFORM		
	MHz	V	ppm		pF	
RB60M00000L513	60.000000	5.0	±50	HCMOS	30	Tri-State (Output Enable)
RB60M00000L515	60.000000	5.0	±50	HCMOS	50	Tri-State (Output Enable)
RB64M00000L311	64.000000	3.3	±50	HCMOS	15	Tri-State (Output Enable)
RB64M00000L313	64.000000	3.3	±50	HCMOS	30	Tri-State (Output Enable)
RB64M00000L315	64.000000	3.3	±50	HCMOS	50	Tri-State (Output Enable)
RB64M00000L511	64.000000	5.0	±50	HCMOS	15	Tri-State (Output Enable)
RB64M00000L513	64.000000	5.0	±50	HCMOS	30	Tri-State (Output Enable)
RB64M00000L515	64.000000	5.0	±50	HCMOS	50	Tri-State (Output Enable)
RB65M53600L101	65.536000	5.0	±50	TTL	15	Enable/Disable
RB65M53600L311	65.536000	3.3	±50	HCMOS	15	Tri-State (Output Enable)
RB65M53600L313	65.536000	3.3	±50	HCMOS	30	Tri-State (Output Enable)
RB65M53600L315	65.536000	3.3	±50	HCMOS	50	Tri-State (Output Enable)
RB65M53600L511	65.536000	5.0	±50	HCMOS	15	Tri-State (Output Enable)
RB65M53600L513	65.536000	5.0	±50	HCMOS	30	Tri-State (Output Enable)
RB65M53600L515	65.536000	5.0	±50	HCMOS	50	Tri-State (Output Enable)
RB66M00000L311	66.000000	3.3	±50	HCMOS	15	Tri-State (Output Enable)
RB66M00000L313	66.000000	3.3	±50	HCMOS	30	Tri-State (Output Enable)
RB66M00000L315	66.000000	3.3	±50	HCMOS	50	Tri-State (Output Enable)
RB66M00000L511	66.000000	5.0	±50	HCMOS	15	Tri-State (Output Enable)
RB66M00000L513	66.000000	5.0	±50	HCMOS	30	Tri-State (Output Enable)

ELECTRICAL PARAMETERS – FOR DIFFERENT PART CODE- Ta = 25°C

PART CODE	FREQUENCY	SUPPLY	FREQUENCY	OUTPUT	OUTLOAD	TRISTATE FUNCTION
	Range	VOLTAGE	Tolerance	WAVEFORM		
	MHz	V	ppm		pF	
RB66M0000L515	66.000000	5.0	±50	HCMOS	50	Tri-State (Output Enable)
RB80M0000L100	80.000000	5.0	±50	HCMOS	15	Tri-State (Output Enable)
RB80M0000L311	80.000000	3.3	±50	HCMOS	15	Tri-State (Output Enable)
RB80M0000L313	80.000000	3.3	±50	HCMOS	30	Tri-State (Output Enable)
RB80M0000L315	80.000000	3.3	±50	HCMOS	50	Tri-State (Output Enable)
RB80M0000L511	80.000000	5.0	±30	HCMOS	15	Tri-State (Output Enable)
RB80M0000L513	80.000000	5.0	±50	HCMOS	30	Tri-State (Output Enable)
RB80M0000L515	80.000000	5.0	±50	HCMOS	50	Tri-State (Output Enable)
RB96M0000L311	96.000000	3.3	±50	HCMOS	15	Tri-State (Output Enable)
RB96M0000L313	96.000000	3.3	±50	HCMOS	30	Tri-State (Output Enable)
RB96M0000L315	96.000000	3.3	±50	HCMOS	50	Tri-State (Output Enable)
RB100M0000L311	100.000000	3.3	±50	HCMOS	15	Tri-State (Output Enable)
RB100M0000L313	100.000000	3.3	±50	HCMOS	30	Tri-State (Output Enable)
RB100M0000L315	100.000000	3.3	±50	HCMOS	50	Tri-State (Output Enable)
RB100M0000L511	100.000000	5.0	±50	HCMOS	15	Tri-State (Output Enable)
RB100M0000L513	100.000000	5.0	±50	HCMOS	30	Tri-State (Output Enable)
RB100M0000L515	100.000000	5.0	±50	HCMOS	50	Tri-State (Output Enable)

IMPORTANT NOTES AND DISCLAIMER

1. **ROHS COMPLIANCE:** The levels of RoHS restricted materials in this product are below the maximum concentration values (also referred to as the threshold limits) permitted for such substances, or are used in an exempted application, in accordance with EU RoHS Directive (EU) 2015/863 EC (RoHS3). RoHS Test Report for this product can be obtained at Download Center.
2. **REACH COMPLIANCE:** REACH substances of high concern (SVHCs) information is available for this product. Since the European Chemical Agency (ECHA) has published notice of their intent to frequently revise the SVHC listing for the foreseeable future, REACH Test Report for this product can be obtained at Download Center.
3. All Product parametric performance is indicated in the Electrical Characteristics for the listed herein test conditions, unless otherwise noted. Product performance may not be indicated by the Electrical Characteristics if operated under different conditions.
4. NextGen Component, Inc (*NextGen*) reserves the right to make changes to this document and its products and specifications at any time without notice. Customers should obtain and confirm the latest product information and specifications before final design, purchase or use.
5. *NextGen* makes no warranty, representation or guarantee regarding the suitability of its products for any particular purpose, not does *NextGen* assume any liability for application assistance or customer product design.
6. *NextGen* does not warrant or accept any liability with products which are purchased or used for any unintended or unauthorized application. No license is granted by implication or otherwise under any intellectual property rights of NextGen.
7. *NextGen* products are not authorized for use as critical components in life support devices or systems without express written approval by *NextGen*.
8. *NextGen* requires that customers first obtain an RMA (Returned Merchandise Authorization) number prior to returning any products. Returns must be made within 30 days of the date of invoice, be in the original packaging, unused and like-new condition. At the time of quoting or purchasing, a product may say that it is Non-Cancelable/ Non-Returnable (NCNR). These products are not returnable and not refundable.