



SPECIFICATION SHEET NO.	S0304- RD685M400HGHR	
ORIGINAL MFG/PART NO	Aillen Capacitors/CBE685M2GHRDG16RR	
NEXTGEN PART CODE	RD685M400HGHR	Indicate This Code For RFQ /Order
DATE	Mar. 04, 2025	
REVISION	A2	Updated With Most Recent Data
DESCRIPTION AND MAIN PARAMETRICS	<p>Dip Aluminum Electrolytic Capacitors, Radial Type, RD series, 2 Pins Capacitance: 6.8μF, Tolerance ±20%, Voltage 400V, Case size: Ø10.0*L16.0mm, Ripple Current: 230mA Max. @105°C, 100kHz Load Life: 8,000 Hours @105°C, Operating Temp. Range -40°C ~+105°C, Package in Bulk, REACH/RoHS/RoHS III Compliant & Halogen Free</p>	
CUSTOMER		
CUSTOMER PART NUMBER		
CROSS REF. PART NUMBER		
MEMO		

VENDOR APPROVE		
Issued/Checked/Approved		 
Effective Date: Mar. 04, 2025		

CUSTOMER APPROVE
DATE:

MAIN FEATURE

- Through Hole Aluminum Electrolytic Capacitors, Radial Type
- Long Load Life 10,000 hours
- High Working Voltage and High Ripple Current
- Low Impedance
- Available For High Density Surface Mounting
- Rated Voltage Range from 160V to 450V
- Offer Quality Alternatives Parts For Major Brand KEMET/CHEMI-CON/
NICHICON/RUBYCON and more
- Moisture Sensitivity Level (MSL) 1 (Unlimited)
- Package in Bulk, Box and Tape Option
- REACH/RoHS/RoHS III Compliant & Halogen Free



Image shown is a representation only. Exact specifications should be obtained from the product dimension.



MAIN APPLICATION

- For High Frequency Circuits Such As LED Circuit, Switching Power Supply
- Main Board (Voltage Regulation Module) Circuit, Frequency Converter Circuit, Etc.

ELECTRICAL CHARACTERISTICS

- See Page 7 for Different Part Code
- All Products Parameters are Subject To NextGen Components' Final Confirmation.

HOW TO ORDER

- Please Follow Up Part Code Guide And Indicate Part Code RD685M400HGHR For RFQ/Order.

PART CODE GUIDE

RFQ

[Request For Quotation](#)

CODE	NAME	KEY SPECIFICATION OPTION
RD	Product Index	Dip Capacitors Aluminum Electrolytic, Radial Type, Original Series Number CDRD
685	Rated Capacitance	685: 6.8μF; 476: 47μF; 566: 56μF; 686: 68μF; 826: 82μF; 107: 100μF; 127: 120μF; 157: 150μF; 187: 180μF; 227: 220μF 277: 270μF; 337: 330μF; 397: 390μF; 477: 470μF; 567: 560μF 687: 680μF; 827: 820μF; 108: 1000μF; 128: 1200μF; 158: 1500μF; 188: 1800μF; 228: 2200μF; 278: 2700μF; 338: 3300μF; 398: 3900μF; 478: 4700μF; 568: 5600μF; 688: 6800μF; 828: 8200μF; 109: 10000μF;
M	Capacitance Tolerance	M: ±20%; V: -10% ~ +20%
400	Rated Voltage	160: 160V; 200: 200V; 250: 250V; 300: 300V; 350: 350V; 400: 400V; 450V: 450V
H	Environmental Requirements	R: RoHS/RoHS III Complaint Remark: Product Set PVC Sleeve H: RoHS/RoHS III Complaint and Halogen Free, Remark: Product Set PET Sleeve
G	Aluminum Case Diameter	D: Ø5.0mm; E: Ø6.3mm; F: Ø8.0mm; G: Ø10.0mm; I: Ø12.5mm; J: Ø13.0mm; K: Ø16.0mm; L: Ø18.0mm; N: Ø22.0mm
H	Aluminum Case Height	When the code is number, it represent the actual height. E.g. 7: L7.0mm; 8: L8.0mm; 9: L9.0mm; A: L11mm; B: L11.5mm; C: L12mm; D: L12.5mm; E: L20mm; F: L21.5mm; G: L31.5mm; H: 16mm; I: 24.5mm; J: L25mm; K: L30mm; L: L31.5mm; M: L35mm; N: L35.5mm; O: L40mm
RR	Lead Pitch/Package (see Page 22 ~ Page 30)	RR: Bulk; R2: Lead Pitch=2.5mm Bulk; T2: Lead Pitch=2.0mm Tape TB: Lead Pitch=2.5mm Tape; T3: Lead Pitch=3.5mm Tape; T5 & TF: Lead Pitch=5.0mm Tape; T7: Lead Pitch=7.5mm Tape; CA: Cutting Lead long=3.0mm; CB: Cutting Lead long=3.5mm; CC: Cutting Lead long=4.0mm; CD: Cutting Lead long=4.5mm
XX	Suffix	Blank: N/A; XX: Internal Control Code, Letter A~Z, a~z or digits (0~9) for Special/Custom Parameters

DIMENSIONS (Unit: mm)



SYMBOL	DIMENSION								
	5.0	6.3	8.0	8.0	10	12.5	13	16	18
D	5.0	6.3	8.0 @L<20	8.0 @L≥20	10	12.5	13	16	18
F	2.0	2.5	2.5/3.5	3.5	5.0	5.0	5.0	7.5	7.5
d	0.5			0.6	0.6	0.6	0.6	0.8	0.8
α	1.5: L < 20; 2.0: @L≥20								

MARKING GUIDE

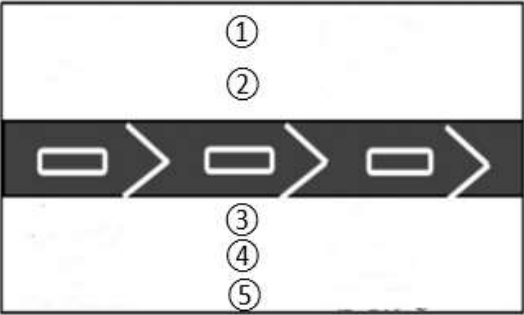
NAME	SYMBOL	CONTENT
Nominal Capacitance	①	6.8 μ F
Rated Voltage	②	400V
Polarity		
Original Manufacturer	③	Aillen
QC Code and Series Code	④	CDRD
Temperature Range	⑤	-40~+105°C
Casing Type		Sleeve And Printing Color: White Printing on brown Sleeve
Marking		

CONSTRUCTION

Single ended type to be produced to fix the terminals to anode and cathode foil, and wind together with paper, and then wound element to be impregnated with electrolyte will be enclosed in an aluminum case. Finally sealed up tightly with end seal rubber, then finished by putting on the vinyl sleeve.



NO.	COMPONENT	MATERIAL
1	Lead Line	Tinned CP Wire (Pb Free)
2	Terminal	Aluminum Wire
3	Sealing Material	Rubber
4	Al-Foil (+)	Formed Aluminum Foil
5	Al-Foil (-)	Etched Aluminum Foil Or Formed Aluminum Foil
6	Case	Aluminum Case
7	Sleeve	PET
8	Separator	Electrolyte Paper

GENERAL ELECTRICAL CHARACTERISTICS – FOR DIFFERENT PART CODE

PARAMETER	Condition	UNITS	VALUE
Operating Junction Temperature Range	Rated voltage is (160~400WV)	°C	-40 ~ +105
Operating Junction Temperature Range	Rated voltage is 450WV	°C	-25 ~ +105

ELECTRICAL CHARACTERISTICS - Ta = 25°C, FOR DIFFERENT PART CODE

Part Code	Capacitance @20°C	Rate Voltage	Surge Voltage	Max. Dissipation Factor @+20°C 120Hz	Max. Ripple Current @at 105°C, 120kHz	Load Life @ 105°C	CASE SIZE Ø D*L
	µF	V	V	%	mA rms	Hour	mm
RD335M400HFCRR	3.3	400	450	20	110	8000	8x12
RD685M400HGHR	6.8	400	450	20	230	8000	10x16
RD476M200HIET5	47	200	250	15	790	10000	12.5x20
RD476M250HIERR	47	250	300	15	834	10000	12.5x20
RD476M450HKJRR	47	450	500	20	936	10000	16x25
RD686M350HKJRR	68	350	400	20	910	10000	16x25
RD686M350HKKRR	68	350	400	20	1100	10000	16x30
RD686M450HLJRR	68	450	500	20	1054	10000	18x25
RD826M400HLJRR	82	400	450	20	1220	10000	18x25
RD127M300HKIRR	120	300	350	20	1350	10000	16x24.5
RD157V400HNKRR	150	400	450	20	2580	10000	22x30

MULTIPLIER FOR RIPPLE CURRENT

Frequency Coefficient

Frequency (Hz) Coefficient	120	1K	10K	100K
Cap. (μF)				
1~5.6	0.40	0.65	0.80	1.00
6.8~180	0.60	0.75	0.90	1.00
≥220	0.70	0.85	0.94	1.00

Temperature Coefficient

Ambient Temperature (°C)	105	85	≤70
Coefficient	1.0	1.7	2.0

Cutting The Feet Long

Cutting Length Code	Cutting Length (mm)
CA	3.0±0.5
CB	3.5±0.5
CC	4.0±0.5
CD	4.5±0.5
CE	5.0±0.5
CG	6.0±0.5
And so on.....	

Note:

- The length of the product’s cut feet starts from A=3.0mm. Every time it increases by 0.5mm.
- The English word is pushed forward one place, as shown in the table.

CHARACTERISTICS

Standard atmospheric conditions

The standard range of atmospheric conditions for making measurements/test as follows:

Ambient temperature: 15°C to 35°C

Relative humidity: 45% to 85%

Air Pressure: 86kPa to 106kPa

If there is any doubt about the results, measurement shall be made within the following conditions:

Ambient temperature: 20°C ± 2°C

Relative humidity: 60% to 70%

Air Pressure: 86kPa to 106kPa

Operating temperature range

The ambient temperature range at which the capacitor can be operated continuously at rated voltage is

(6.3~400WV), -40~+105°C. (450WV), -25~+105°C. As to the detailed information, please refer to following table.

ITEM	CHARACTERISTICS																						
Nominal Capacitance (Tolerance)	<p><Condition></p> <p>Measuring Frequency : 120Hz±12Hz</p> <p>Measuring Voltage : Not more than 0.5V</p> <p>Measuring Temperature : 20±2°C</p> <p><Criteria></p> <p>Shall be within the specified capacitance tolerance</p>																						
Leakage Current	<p><Condition></p> <p>After DC Voltage is applied to capacitors through the series protective resistor (1kΩ±10Ω) so that terminal voltage may reach the reacted use voltage. The leakage current when measured in 2 minutes shall not exceed the values of the following equation.</p> <p><Criteria></p> <p>$I (\mu A) \leq 0.02CV + 25 (\mu A)$.</p> <p>I: Leakage current (μA)</p> <p>C: Capacitance (μF)</p> <p>V: Rated DC working voltage (V)</p>																						
tanδ	<p><Condition></p> <p>See Nominal capacitance, for measuring frequency, voltage and temperature.</p> <p><Criteria></p> <table border="1" data-bbox="415 1338 893 1504"> <tr> <td>Working voltage (V)</td> <td>160~250</td> <td>300~500</td> </tr> <tr> <td>Tan δ Max.(%)</td> <td>0.15</td> <td>0.20</td> </tr> </table>	Working voltage (V)	160~250	300~500	Tan δ Max.(%)	0.15	0.20																
Working voltage (V)	160~250	300~500																					
Tan δ Max.(%)	0.15	0.20																					
Rated Voltage (WV)/Surge Voltage (SV)	<table border="1" data-bbox="415 1578 1343 1686"> <tr> <td>WV (V)</td> <td>160</td> <td>200</td> <td>250</td> <td>300</td> <td>315</td> <td>350</td> <td>400</td> <td>420</td> <td>450</td> <td>500</td> </tr> <tr> <td>SV (V)</td> <td>200</td> <td>250</td> <td>300</td> <td>350</td> <td>365</td> <td>400</td> <td>450</td> <td>470</td> <td>500</td> <td>550</td> </tr> </table>	WV (V)	160	200	250	300	315	350	400	420	450	500	SV (V)	200	250	300	350	365	400	450	470	500	550
WV (V)	160	200	250	300	315	350	400	420	450	500													
SV (V)	200	250	300	350	365	400	450	470	500	550													

ITEM	CHARACTERISTICS																																							
Terminal Strength IEC-60384-4 4.4	<p><Condition></p> <p>Tensile strength of terminals. Fixed the capacitor, applied force to the terminal in lead out direction for 10 ± 1 seconds. Bending strength of terminals. Fixed the capacitor, applied force to bent the terminal (1~4 mm from the rubber) for 90° within 2~3 seconds, and then bent it for 90° to its original position within 2~3 Seconds.</p> <table border="1" data-bbox="444 669 1285 824"> <thead> <tr> <th>Diameter of lead wire</th> <th>Tensile force N (kgf)</th> <th>Bending force N (kgf)</th> </tr> </thead> <tbody> <tr> <td>0.5mm and less</td> <td>5 (0.51)</td> <td>2.5 (0.25)</td> </tr> <tr> <td>Over 0.5mm to 0.8mm</td> <td>10 (1.0)</td> <td>5 (0.51)</td> </tr> </tbody> </table> <p><Criteria></p> <p>No noticeable changes shall be found, no breakage or looseness at the terminal</p>	Diameter of lead wire	Tensile force N (kgf)	Bending force N (kgf)	0.5mm and less	5 (0.51)	2.5 (0.25)	Over 0.5mm to 0.8mm	10 (1.0)	5 (0.51)																														
Diameter of lead wire	Tensile force N (kgf)	Bending force N (kgf)																																						
0.5mm and less	5 (0.51)	2.5 (0.25)																																						
Over 0.5mm to 0.8mm	10 (1.0)	5 (0.51)																																						
Temperature Characteristics IEC-60384-4 4.12	<p><Condition></p> <table border="1" data-bbox="444 1006 1285 1313"> <thead> <tr> <th>Step</th> <th>Testing temperature(°C)</th> <th>Time</th> </tr> </thead> <tbody> <tr> <td>1</td> <td>20 ± 2</td> <td>Time to reach thermal equilibrium</td> </tr> <tr> <td>2</td> <td>$(-40) -25 \pm 3$</td> <td>Time to reach thermal equilibrium</td> </tr> <tr> <td>3</td> <td>20 ± 2</td> <td>Time to reach thermal equilibrium</td> </tr> <tr> <td>4</td> <td>105 ± 2</td> <td>Time to reach thermal equilibrium</td> </tr> <tr> <td>5</td> <td>20 ± 2</td> <td>Time to reach thermal equilibrium</td> </tr> </tbody> </table> <p><Criteria></p> <ul style="list-style-type: none"> At $+105^\circ\text{C}$: capacitance measured shall be within $\pm 20\%$ of its original value at $+20^\circ\text{C}$: $\tan \delta$ shall be within the limit of $\tan \delta$, The leakage current value at $+105^\circ\text{C}$ shall not more than 8 times the specified value. In step 5, $\tan \delta$ shall be within the limit of $\tan \delta$, The leakage current shall not more than the specified value. At -40°C (-25°C) : Impedance (Z) ratio shall not exceed the following value. <table border="1" data-bbox="444 1672 1189 1844"> <thead> <tr> <th>Rated Voltage (V)</th> <th>160</th> <th>200</th> <th>300</th> <th>350</th> <th>400</th> <th>450</th> </tr> </thead> <tbody> <tr> <td>Z-25°C/ Z +20°C</td> <td>3</td> <td>3</td> <td>3</td> <td>5</td> <td>5</td> <td>6</td> </tr> <tr> <td>Z-40°C/ Z +20°C</td> <td>6</td> <td>6</td> <td>6</td> <td>6</td> <td>6</td> <td>/</td> </tr> </tbody> </table> <p>Capacitance, $\tan \delta$, and impedance shall be measured at 120Hz.</p>	Step	Testing temperature(°C)	Time	1	20 ± 2	Time to reach thermal equilibrium	2	$(-40) -25 \pm 3$	Time to reach thermal equilibrium	3	20 ± 2	Time to reach thermal equilibrium	4	105 ± 2	Time to reach thermal equilibrium	5	20 ± 2	Time to reach thermal equilibrium	Rated Voltage (V)	160	200	300	350	400	450	Z- 25°C / Z + 20°C	3	3	3	5	5	6	Z- 40°C / Z + 20°C	6	6	6	6	6	/
Step	Testing temperature(°C)	Time																																						
1	20 ± 2	Time to reach thermal equilibrium																																						
2	$(-40) -25 \pm 3$	Time to reach thermal equilibrium																																						
3	20 ± 2	Time to reach thermal equilibrium																																						
4	105 ± 2	Time to reach thermal equilibrium																																						
5	20 ± 2	Time to reach thermal equilibrium																																						
Rated Voltage (V)	160	200	300	350	400	450																																		
Z- 25°C / Z + 20°C	3	3	3	5	5	6																																		
Z- 40°C / Z + 20°C	6	6	6	6	6	/																																		

ITEM	CHARACTERISTICS								
<p>Load Life Test IEC-60384-4 4.13</p>	<p><Condition> According to IEC60384-4 No.4.13 methods, The capacitor is stored at a temperature of $105 \pm 2^\circ \text{C}$ with DC bias voltage plus the rated ripple current for $\phi 8 \sim \phi 10$: 8000H+48/0 hours., $\phi 12.5 \sim \phi 18$: 10000H+48/0hours. (The sum of DC and ripple peak voltage shall not exceed the rated working voltage) Then the product should be tested after 16 hours recovering time at atmospheric conditions. The result should meet the following table:</p> <p><Criteria> : The characteristic shall meet the following requirements.</p> <table border="1" data-bbox="425 886 1268 1183"> <tr> <td>Leakage current</td> <td>Value in 4.2 shall be satisfied</td> </tr> <tr> <td>Capacitance Change</td> <td>Within $\pm 20\%$ of initial value</td> </tr> <tr> <td>$\tan \delta$</td> <td>Not more than 200% of the specified value.</td> </tr> <tr> <td>Appearance</td> <td>There shall be no leakage of electrolyte.</td> </tr> </table>	Leakage current	Value in 4.2 shall be satisfied	Capacitance Change	Within $\pm 20\%$ of initial value	$\tan \delta$	Not more than 200% of the specified value.	Appearance	There shall be no leakage of electrolyte.
Leakage current	Value in 4.2 shall be satisfied								
Capacitance Change	Within $\pm 20\%$ of initial value								
$\tan \delta$	Not more than 200% of the specified value.								
Appearance	There shall be no leakage of electrolyte.								
<p>Vent Test IEC-60384-4 4.16</p>	<p><Condition> The following test only apply to those products with vent products at diameter $\geq \phi 6.3$ with vent. D.C. test: The capacitor is connected with its polarity reversed to a DC power source. Then a current selected from Table 2 is applied.</p> <table border="1" data-bbox="425 1545 1268 1653"> <tr> <td>Diameter (mm)</td> <td>DC Current (A)</td> </tr> <tr> <td>22.4 or less</td> <td>1</td> </tr> </table> <p><Criteria> The vent shall operate with no dangerous conditions such as flames or dispersion of pieces of the capacitor and/or case.</p>	Diameter (mm)	DC Current (A)	22.4 or less	1				
Diameter (mm)	DC Current (A)								
22.4 or less	1								

ITEM	CHARACTERISTICS																
<p>Shelf Life Test IEC-60384-4 4.17</p>	<p><Condition>: The capacitors are then stored with no voltage applied at a temperature of 105±2°C for 1000+48/0 hours. Following this period the capacitors shall be removed from the test chamber and be allowed to stabilized at room temperature for 4~8 hours. Next they shall be connected to a series limiting resistor(1k±100Ω) with D.C. rated voltage applied for 30min. After which the capacitors shall be discharged, and then, tested the characteristics.</p> <p><Criteria> : The characteristic shall meet the following requirements.</p> <table border="1" data-bbox="411 795 1250 1044"> <tr> <td>Leakage current</td> <td>Value in 4.2 shall be satisfied</td> </tr> <tr> <td>Capacitance Change</td> <td>Within ± 20% of initial value</td> </tr> <tr> <td>tanδ</td> <td>Not more than 200% of the specified value.</td> </tr> <tr> <td>Appearance</td> <td>There shall be no leakage of electrolyte.</td> </tr> </table> <p>Remark: If the capacitors are stored more than 1 year, the leakage current may increase. Please apply voltage through about 1 K Ω resistor, if necessary.</p>	Leakage current	Value in 4.2 shall be satisfied	Capacitance Change	Within ± 20% of initial value	tanδ	Not more than 200% of the specified value.	Appearance	There shall be no leakage of electrolyte.								
Leakage current	Value in 4.2 shall be satisfied																
Capacitance Change	Within ± 20% of initial value																
tanδ	Not more than 200% of the specified value.																
Appearance	There shall be no leakage of electrolyte.																
<p>Change Of Temperature Test IEC-60384-4 4.7</p>	<p><Condition> Temperature cycle: According to IEC60384-4 No.4.7 methods, capacitor shall be placed in an oven, the condition according as below:</p> <table border="1" data-bbox="411 1301 1288 1612"> <thead> <tr> <th>Temperature</th> <th>Time</th> </tr> </thead> <tbody> <tr> <td>(1)+20°C</td> <td>≤ 3 Minutes</td> </tr> <tr> <td>(2)-25°C (-40°C)</td> <td>30 ± 2 Minutes</td> </tr> <tr> <td>(3)+105°C</td> <td>30 ± 2 Minutes</td> </tr> <tr> <td colspan="2">(1) To (3) = 1 cycle, Total 5 Cycles</td> </tr> </tbody> </table> <p><Criteria> The characteristic shall meet the following requirement.</p> <table border="1" data-bbox="411 1740 1288 1926"> <tr> <td>Leakage current</td> <td>Not more than the specified value.</td> </tr> <tr> <td>Tan δ</td> <td>Not more than the specified value.</td> </tr> <tr> <td>Appearance</td> <td>There shall be no leakage of electrolyte.</td> </tr> </table>	Temperature	Time	(1)+20°C	≤ 3 Minutes	(2)-25°C (-40°C)	30 ± 2 Minutes	(3)+105°C	30 ± 2 Minutes	(1) To (3) = 1 cycle, Total 5 Cycles		Leakage current	Not more than the specified value.	Tan δ	Not more than the specified value.	Appearance	There shall be no leakage of electrolyte.
Temperature	Time																
(1)+20°C	≤ 3 Minutes																
(2)-25°C (-40°C)	30 ± 2 Minutes																
(3)+105°C	30 ± 2 Minutes																
(1) To (3) = 1 cycle, Total 5 Cycles																	
Leakage current	Not more than the specified value.																
Tan δ	Not more than the specified value.																
Appearance	There shall be no leakage of electrolyte.																

ITEM	CHARACTERISTICS								
<p>Surge Test IEC-60384-4. 4.9</p>	<p><Condition> Test temperature:15~35°C; Series resistor: $R = (100 \pm 50)/C$ R: protective resistor (KΩ); C: nominal capacitance (μF) Test voltage: Surge voltage item 4.4 No. of cycles: 1000cycles Each cycles lasts for 6 ± 0.5min “ON” for 30 ± 5 s “OFF” for 5 ± 0.5min. <Criteria></p> <table border="1" data-bbox="444 700 1283 948"> <tr> <td>Leakage current</td> <td>Not more than the specified value</td> </tr> <tr> <td>Capacitance Change</td> <td>Within $\pm 15\%$ of initial value</td> </tr> <tr> <td>tanδ</td> <td>Not more than the specified value</td> </tr> <tr> <td>Appearance</td> <td>There shall be no leakage of electrolyte.</td> </tr> </table> <p>Attention: This test simulates over voltage at abnormal situation only, and not be hypothesizing that over voltage is always applied.</p>	Leakage current	Not more than the specified value	Capacitance Change	Within $\pm 15\%$ of initial value	tanδ	Not more than the specified value	Appearance	There shall be no leakage of electrolyte.
Leakage current	Not more than the specified value								
Capacitance Change	Within $\pm 15\%$ of initial value								
tanδ	Not more than the specified value								
Appearance	There shall be no leakage of electrolyte.								
<p>Solderability Test IEC-60384-4 4.6</p>	<p><Condition> The capacitor shall be tested under the following conditions: Soldering temperature : $245 \pm 3^\circ\text{C}$; Dipping depth : 2mm ; Dipping speed : 25 ± 2.5mm/s Dipping time : 3 ± 0.5s <Criteria> Coating quality : A minimum of 95% of the surface being immersed</p>								

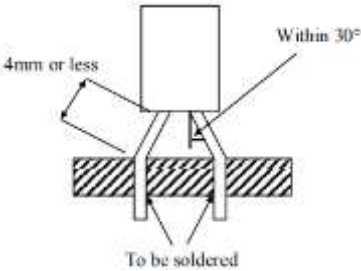
ITEM	CHARACTERISTICS								
<p>Vibration Test IEC-60384-4.4.8</p>	<p><Condition> The following conditions shall be applied for 2 hours in each 3 mutually perpendicular directions. Vibration frequency range : 10Hz ~ 55Hz; Peak to peak amplitude : 1.5mm Sweep rate : 10Hz ~ 55Hz ~ 10Hz in about 1 minute Mounting method: The capacitor with diameter greater than 12.5mm or longer than 25mm must be fixed in place with a bracket.</p>  <p><Criteria> After the test, the following items shall be tested:</p> <table border="1" data-bbox="425 1052 1315 1272"> <tr> <td>Inner construction</td> <td>No intermittent contacts, open or short circuiting. No damage of tab terminals or electrodes</td> </tr> <tr> <td>Appearance</td> <td>No mechanical damage in terminal. No leakage of electrolyte or swelling of the case. The markings shall be legible</td> </tr> </table>	Inner construction	No intermittent contacts, open or short circuiting. No damage of tab terminals or electrodes	Appearance	No mechanical damage in terminal. No leakage of electrolyte or swelling of the case. The markings shall be legible				
Inner construction	No intermittent contacts, open or short circuiting. No damage of tab terminals or electrodes								
Appearance	No mechanical damage in terminal. No leakage of electrolyte or swelling of the case. The markings shall be legible								
<p>Resistance To Solder Heat Test IEC-60384-4 4.5</p>	<p><Condition> Terminals of the capacitor shall be immersed into solder bath at 260±5°C for 10±1 seconds or 400±10°C for 3~4 seconds to 1.5~2.0mm from the body of capacitor. Then the capacitor shall be left under the normal temperature and normal humidity for 1~2 hours before measurement.</p> <p><Criteria></p> <table border="1" data-bbox="425 1674 1300 1922"> <tr> <td>Leakage current</td> <td>Not more than the specified value</td> </tr> <tr> <td>Capacitance Change</td> <td>Within ± 10% of initial value</td> </tr> <tr> <td>tanδ</td> <td>Not more than the specified value</td> </tr> <tr> <td>Appearance</td> <td>There shall be no leakage of electrolyte.</td> </tr> </table>	Leakage current	Not more than the specified value	Capacitance Change	Within ± 10% of initial value	tanδ	Not more than the specified value	Appearance	There shall be no leakage of electrolyte.
Leakage current	Not more than the specified value								
Capacitance Change	Within ± 10% of initial value								
tanδ	Not more than the specified value								
Appearance	There shall be no leakage of electrolyte.								

ITEM	CHARACTERISTICS																
<p>Change Of Temperature Test IEC-60384-4 4.7</p>	<p><Condition> Temperature cycle: According to IEC60384-4 No.4.7 methods, capacitor shall be placed in an oven, the condition according as below:</p> <table border="1" data-bbox="444 474 1286 733"> <thead> <tr> <th>Temperature</th> <th>Time</th> </tr> </thead> <tbody> <tr> <td>(1)+20°C</td> <td>≤ 3 Minutes</td> </tr> <tr> <td>(2)-25°C(-40°C)</td> <td>30± 2 Minutes</td> </tr> <tr> <td>(3)+105°C</td> <td>30± 2 Minutes</td> </tr> <tr> <td colspan="2">(1) To (3) = 1 cycle, Total 5 Cycles</td> </tr> </tbody> </table> <p><Criteria> The characteristic shall meet the following requirement.</p> <table border="1" data-bbox="444 861 1286 1017"> <tbody> <tr> <td>Leakage current</td> <td>Not more than the specified value.</td> </tr> <tr> <td>Tan δ</td> <td>Not more than the specified value.</td> </tr> <tr> <td>Appearance</td> <td>There shall be no leakage of electrolyte.</td> </tr> </tbody> </table>	Temperature	Time	(1)+20°C	≤ 3 Minutes	(2)-25°C(-40°C)	30± 2 Minutes	(3)+105°C	30± 2 Minutes	(1) To (3) = 1 cycle, Total 5 Cycles		Leakage current	Not more than the specified value.	Tan δ	Not more than the specified value.	Appearance	There shall be no leakage of electrolyte.
Temperature	Time																
(1)+20°C	≤ 3 Minutes																
(2)-25°C(-40°C)	30± 2 Minutes																
(3)+105°C	30± 2 Minutes																
(1) To (3) = 1 cycle, Total 5 Cycles																	
Leakage current	Not more than the specified value.																
Tan δ	Not more than the specified value.																
Appearance	There shall be no leakage of electrolyte.																
<p>Damp Heat Test IEC-60384-4 4.12</p>	<p><Condition> Humidity test: According to IEC60384-4 No.4.12 methods, capacitor shall be exposed for 500±8 hours in an atmosphere of 90~95%R H .at 40±2°C, the characteristic change shall meet the following requirement.</p> <p><Criteria></p> <table border="1" data-bbox="444 1400 1286 1607"> <tbody> <tr> <td>Leakage current</td> <td>Not more than the specified value.</td> </tr> <tr> <td>Capacitance Change</td> <td>Within ± 20% of initial value..</td> </tr> <tr> <td>tan δ</td> <td>Not more than 120% of the specified value.</td> </tr> <tr> <td>Appearance</td> <td>There shall be no leakage of electrolyte.</td> </tr> </tbody> </table>	Leakage current	Not more than the specified value.	Capacitance Change	Within ± 20% of initial value..	tan δ	Not more than 120% of the specified value.	Appearance	There shall be no leakage of electrolyte.								
Leakage current	Not more than the specified value.																
Capacitance Change	Within ± 20% of initial value..																
tan δ	Not more than 120% of the specified value.																
Appearance	There shall be no leakage of electrolyte.																

FORMING DIMENSION - Unit : mm

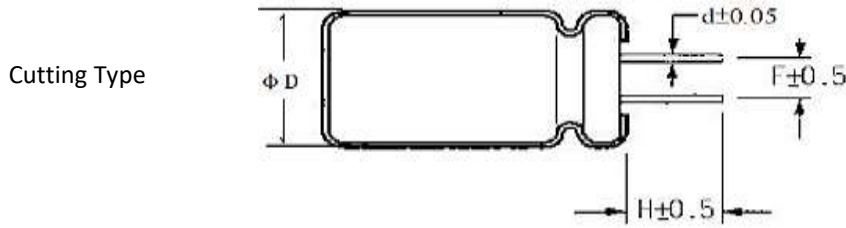

Shape Code	D	5.0	6.3	8.0	10~13	16~18
CB Cutting- 3.5mm	F	2.0	2.5	3.5	5.0	7.5
	H	3.5	3.5	3.5	3.5	3.5
	d	0.5	0.5	0.5	0.6	0.8

Shape Code	D	5.0	6.3	8.0	10~13	16~18
CC Cutting- 4.0mm	F	2.0	2.5	3.5	5.0	7.5
	H	4.0	4.0	4.0	4.0	4.0
	d	0.5	0.5	0.5	0.6	0.8

Shape Code	D	5.0	6.3	8.0	10~13	16~18
CD Cutting- 4.5mm	F	2.0	2.5	3.5	5.0	7.5
	H	4.5	4.5	4.5	4.5	4.5
	d	0.5	0.5	0.5	0.6	0.8

Shape Code	D	5.0	6.3	8.0	10~13	16~18
CE Cutting- 5.0mm	F	2.0	2.5	3.5	5.0	7.5
	H	5.0	5.0	5.0	5.0	5.0
	d	0.5	0.5	0.5	0.6	0.8

TAPING DIMENSION - Unit : mm

Taping Code \ Item	Symbol	T2	TB	T3	T5
		Fig 1			
Diameter	D	5	6.3	8	10 12.5/ 13
Height	L	9~30			
Lead Diameter	$d \pm 0.05$	0.5	0.5/0.6		0.6
Component Spacing	$P \pm 1.0$	12.7			15.0
Pitch of sprocket holes	$P0 \pm 0.2$	12.7			15.0
Distance between centers of terminal and the sprocket holes	$P1 \pm 0.5$	5.1	4.6		3.85
Feed hole center to component center	$P2 \pm 1.0$	6.35			
Distance between centers of component leads	$F \pm 0.5$	2.0	2.5	3.5	5.0
Carrier tape width	$W \pm 1.0$	18			
Hold down tape width	W0	7 Min.			
Distance between the center of upper edge of carrier tape and sprocket hole	$W1 \pm 0.5$	9			
Distance between the upper edges of the carrier tape and the hold down tape	W2	3.0 Max.			
Distance between the abscissa and the bottom of the components body	$H \pm 1.0$	18.5	20.0		18.5
Distance between the abscissa and the reference plane of the components with crimped leads	$H0 \pm 0.5$	/			
Max. lateral deviation of the component body vertical to the tape plane	Δh	2.0 Max.			
End of lead	L1	0.5 Max.			
Diameter of driving hole	D0	4.0 ± 0.2			
Sun of thickness for mounting and adhesive tape without lead Diameter	t	0.6 ± 0.3			

TAPING DIMENSION - Unit : mm

Taping Code \ Item	Symbol	T5	T7	
		Fig 2		
Diameter	D	12.5/13.0	16	18
Height	L	9~30		
Lead Diameter	$d \pm 0.05$	0.6	0.8	
Component Spacing	$P \pm 1.0$	25.4	25.4	
Pitch of sprocket holes	$P0 \pm 0.2$	12.7	12.7	
Distance between centers of terminal and the sprocket holes	$P1 \pm 0.5$	3.85	3.75	
Feed hole center to component center	$P2 \pm 1.0$	6.35	7.50	
Distance between centers of component leads	$F \pm 0.5$	5.0	7.5	
Carrier tape width	$W \pm 1.0$	18.0		
Hold down tape width	W0	7.0 Min.		
Distance between the center of upper edge of carrier tape and sprocket hole	$W1 \pm 0.5$	9.0		
Distance between the upper edges of the carrier tape and the hold down tape	W2	3.0 Max.		
Distance between the abscissa and the bottom of the components body	$H \pm 1.0$	18.5		
Distance between the abscissa and the reference plane of the components with crimped leads	$H0 \pm 0.5$	/		
Max. lateral deviation of the component body vertical to the tape plane	Δh	2.0 Max.		
End of lead	L1	0.5 Max.		
Diameter of driving hole	D0	4.0 ± 0.2		
Sun of thickness for mounting and adhesive tape without lead Diameter	t	0.6 ± 0.3		

TAPING DIMENSION - Unit : mm

Taping Code	Item	Symbol	TB	T5	TB	T5	TB	T5
			Fig 4	Fig 3	Fig 4	Fig 3	Fig 4	Fig 3
Diameter	D		4		5			
Height	L		5/7				9~12	
Lead Diameter	$d \pm 0.05$		0.45				0.50	
Component Spacing	$P \pm 1.0$		12.7					
Pitch of sprocket holes	$P0 \pm 0.2$		12.7					
Distance between centers of terminal and the sprocket holes	$P1 \pm 0.5$		5.1	3.85	5.1	3.85	5.1	3.85
Feed hole center to component center	$P2 \pm 1.0$		6.35					
Distance between centers of component leads	$F \pm 0.5$		2.5	5.0	2.5	5.0	3.5	5.0
Carrier tape width	$W \pm 1.0$		18					
Hold down tape width	W0		7 Min.					
Distance between the center of upper edge of carrier tape and sprocket hole	$W1 \pm 0.5$		9					
Distance between the upper edges of the carrier tape and the hold down tape	W2		3.0 Max.					
Distance between the abscissa and the bottom of the components body	$H \pm 0.75$		18.5	17.5	18.5	17.5	18.5	17.5
Distance between the abscissa and the reference plane of the components with crimped leads	$H0 \pm 0.5$		/	16.0	/	16.0	/	16.0
Max. lateral deviation of the component body vertical to the tape plane	Δh		2.0 Max.					
End of lead	L1		0.5 Max.					
Diameter of driving hole	D0		4.0 ± 0.2					
Sum of thickness for mounting and adhesive tape without lead Diameter	t		0.6 ± 0.3					

TAPING DIMENSION - Unit : mm

Taping Code \ Item	Symbol	T5					
		Fig 3					
Diameter	D	6.3		8			
Height	L	5/7	9/12	5	7	9~19	20~25
Lead Diameter	$d \pm 0.05$	0.45	0.50	0.45	0.45	0.50	0.60
Component Spacing	$P \pm 1.0$	12.7					
Pitch of sprocket holes	$P0 \pm 0.2$	12.7					
Distance between centers of terminal and the sprocket holes	$P1 \pm 0.5$	3.85			4.6		
Feed hole center to component center	$P2 \pm 1.0$	6.35					
Distance between centers of component leads	$F \pm 0.5$	5.0					
Carrier tape width	$W \pm 1.0$	18					
Hold down tape width	W0	7 Min.					
Distance between the center of upper edge of carrier tape and sprocket hole	$W1 \pm 0.5$	9					
Distance between the upper edges of the carrier tape and the hold down tape	W2	3.0 Max.					
Distance between the abscissa and the bottom of the components body	$H \pm 0.75$	17.5		20			
Distance between the abscissa and the reference plane of the components with crimped leads	$H0 \pm 0.5$	16.0					
Max. lateral deviation of the component body vertical to the tape plane	Δh	2.0 Max.					
End of lead	L1	0.5 Max.					
Diameter of driving hole	D0	4.0 ± 0.2					
Sun of thickness for mounting and adhesive tape without lead Diameter	t	0.6 ± 0.3					

STRAIGHT FOOT BRAID

Fig 1

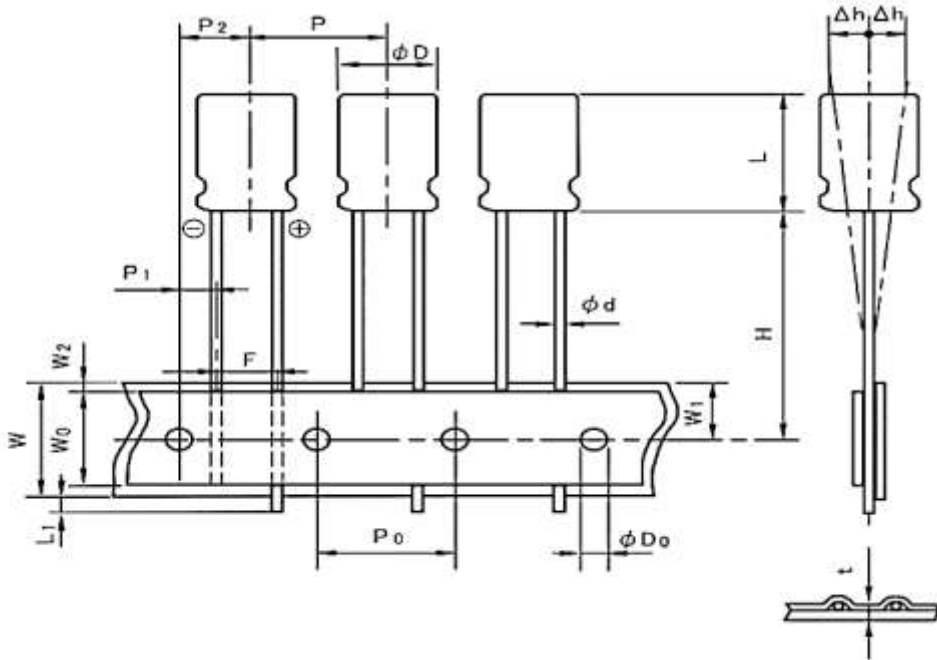
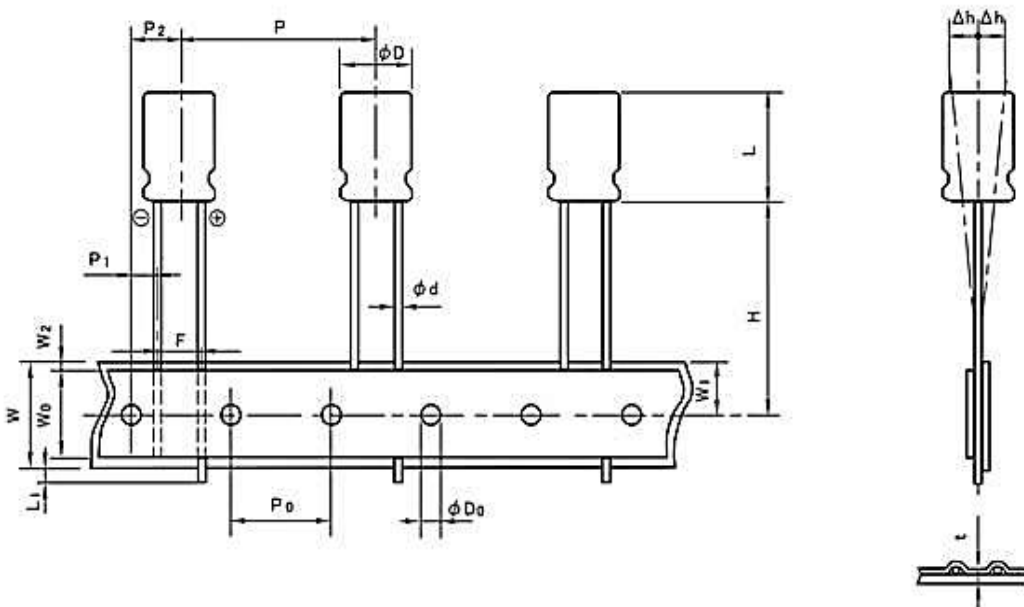

Fig 2



ENLARGE THE FOOT BRAID

Fig 3

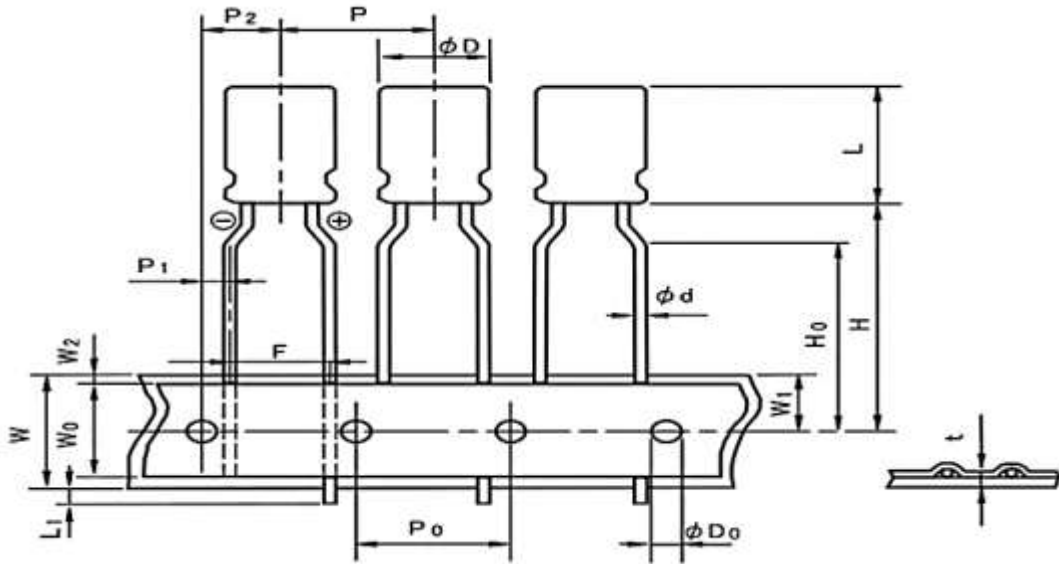
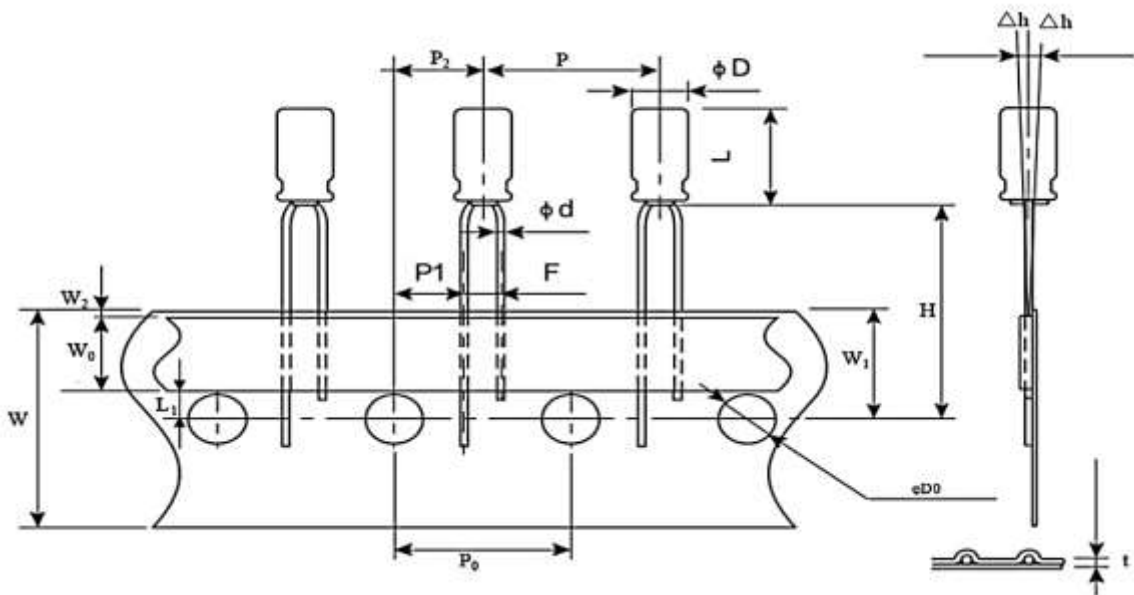

Fig 4



ATTENTION

When using Aluminum Electrolytic Capacitor, please pay attention to the points listed below. If the following types of electrical loads are applied to Aluminum Electrolytic Capacitor, rapid deterioration of electrical property occurs:

- Reverse voltage
- Overvoltage exceeding rated working voltage
- Current exceeding rated ripple current
- Severe charging/discharging

At such times, severe heat is generated, gas is emitted, then electrolyte leaks from the sealed area, and pressure relief vent operates due to increase of internal pressure. In the worst case, explosion or ignition may occur, and along with destruction of the capacitor combustibles may burst out.

CAUTION DURING CIRCUIT DESIGN

1. Operational environments, mounting environment and conditions. Ensure that operational and mounting conditions follow the specified conditions detailed in the catalog and specification sheets
2. Operating temperature, ripple current and load life. Operating temperature and applied ripple current should be within the specified value in the catalog or specification sheets. Do not use Aluminum Electrolytic Capacitors at temperature which exceeds the specified category temperatures range. Do not apply excessive current to the capacitors, which exceeds the specified rated ripple current. During circuit design, please ensure that capacitors are selected to match with the lifetime requirements of the application
3. Application: Aluminum Electrolytic Capacitors are normally polarized. Reverse voltage or AC Voltage should not be applied. When polarity may flip over, non-polar type should be used, but the non-polar type cannot be used for AC. Standard Aluminum Electrolytic Capacitors are not suitable for rapid charge and discharge applications. Group in your area about specialty signed capacitors for rapid charge and discharge.
4. Applied Voltage: Do not exceed the rated voltage of capacitors

5. Insulation: Aluminum Electrolytic Capacitors should be electrically isolated from the following. Aluminum case, cathode lead wire, anode lead wire and circuit pattern; Auxiliary terminals of snap-in type, anode terminal, outward terminals and circuit pattern. The PVC sleeve of Aluminum Electrolytic Capacitors is not recognized as an insulator, and therefore, the standard capacitor should not be used in a place where insulation function is needed. Please consult with NextGen Components, Inc. if you require a higher grade of insulating sleeve.
6. Conditions of use: The following environments should be avoided when using Aluminum Electrolytic Capacitors. Damp conditions such as water, salt water or oil spray or fumes, high humidity or humidity condensation situations. Hazardous gas/fumes such as hydrogen sulfide, sulfurous acid gas, nitrous acid, chlorine gas, ammonia or bromine gas; Exposure of ozone, ultraviolet rays or radiation; Severe vibration or shock which exceeds the condition specified in the catalog or specification sheet.
7. Consideration to assembly condition: In designing a circuit, the following matters should be ensured in advance to the capacitor's assembly on the printed circuit board (PC board) Design the appropriate hole spacing to match the lead pitch of capacitors; Do not locate any wiring and circuit patterns directly above the capacitor's vent; Ensure enough free space above the capacitor's vent. The recommended space is specified in the catalog or specification sheets; In case the capacitor's vent is facing the PC board, make a gas release hole on PC board. The sealing side of the screw terminal type should not face down in the application. When the capacitors are mounted horizontally, the anode screw terminals must be positioned at upper side.
8. Consideration to circuit design: Any copper lines or circuit patterns should not be laid under the capacitor; Parts which radiate heat should not be placed close to the reverse side of the Aluminum Electrolytic Capacitors on the PC board.

9. Others

Performance of electrical characteristics of Aluminum Electrolytic Capacitors is affected by variation of operating temperature and frequency. Consider this variation when designing the circuit. Excessive holes and connection hole between both sides on the PC board should be avoided around or under the mounting area of the Aluminum Electrolytic Capacitors on double sided or multilayer PC board. Torque of tightening screw terminals should not exceed the specified maximum value which is described in the catalog and specification sheets . Consider current balance when 2 or more Aluminum Electrolytic Capacitors are connected in parallel. Use bleeding resistors when 2 or more Aluminum Electrolytic Capacitors are connected in series .In this case, the resistors should be connected parallel to the capacitors.

CAUTION FOR ASSEMBLING CAPACITORS

1. Caution before assembly : Aluminum Electrolytic Capacitors cannot be recycled after mounting and applying electricity in unit. The capacitors, which are removed from PC board for the purpose of measuring electrical characteristics at the periodical inspection, should only be recycled for the same position.; Aluminum Electrolytic Capacitors may accumulate charge naturally during storage. In this case, discharge through a 1KOHM resistor before use; Leakage current of Aluminum Electrolytic Capacitors may be increased during long storage time. In this case, the capacitors should be subject to voltage treatment through a 1KOHM resistor before use.
2. In the assembly process-1: Ensure rated voltage and capacitance of the capacitors before mounting; Ensure capacitors polarity before mounting; Do not use a capacitor which has been dropped onto a hard surface; Do not use a capacitor with damaged or dented cased or seals.
3. In the assembly process-2: Capacitors should be mounted after confirmation that hole spacing on PC board matches the lead pitch of the capacitors; The snap-in type of capacitors should be mounted firmly on the PC board without a gap between the capacitor body and the surface of PC board;. Avoid excessive force when clinching lead wire during auto-insertion process; Avoid excessive shock to capacitors by automatic inserting machine, during mounting, parts inspection or centering operations; Please utilize supporting material such as strap of adhesive to mount capacitors to PC board when it is anticipated that vibration or shock is applied.

4. Soldering: Soldering conditions (temperature and time) should be within the specified conditions which are described in the catalog or specification sheets; In case lead wire reforming is needed due to inappropriate pitch between capacitor and holes on PC board, stress to the capacitor should be avoided; In case of maintenance by soldering iron, if it is required to detach the capacitor, it should be removed from PC board after solder has melted sufficiently in order to reduce stress on the lead wires/terminals of the capacitor; Soldering iron should never touch the capacitor's body.
5. Flow soldering: Do not dip capacitor's body into melted solder. It should only be soldered on the reverse side of the PC board on which the capacitors are mounted; Soldering condition (preheat, soldering temperature, dipping time) should be within the specified standard which is described in the catalog or specification sheets; Flux should not be adhered to capacitor's body but only to its terminals; Other devices which are mounted close to capacitors should not touch the capacitors.
6. Reflow soldering: Reflow soldering conditions (preheat, soldering, temperature, reflow time) should follow the specified standard which is described in the catalog or specification sheets; Heating standard should depend on surface of the capacitor color or materials when infrared rays are used because the capacitor's heat absorption depends on the surface color or materials. Check heat condition; Standard Aluminum Electrolytic Capacitors cannot withstand two or more reflow processes.
7. Handling after soldering: Do not bend or twist the capacitor's body after soldering on PC board; Do not pick-up or move PC board by holding the soldered capacitors; Do not hit the capacitors and isolate capacitors from the PC board or other device when stacking PC boards in store.
8. PC board cleaning: Standard Aluminum Electrolytic Capacitors should be free from halogenated solvents during PC board cleaning after soldering
9. Adhesives and coating materials: Do not use halogenated adhesives and coating materials to fix Aluminum Electrolytic Capacitors; Flux between the surface of the PC board and sealing of capacitors should be cleaned before using adhesives or coating materials; Solvents should be dried up before using adhesives or coating materials; Do not cover up all the sealing area of capacitors with adhesives or coating materials, make coverage only partial.

CAUTION DURING USE OF CAPACITORS IN SETS

1. Do not touch the terminals of capacitors;
2. Do not connect electrical terminals of the capacitors. Keep the capacitors free from conductive solution, such as acid, alkali and so on;
3. Ensure the operational environment of the equipment in which the capacitor has been built is within the specified condition mentioned in the catalog or specification sheets.

MAINTENANCE

1. Periodical inspection should be carried out for the capacitors, which are used with industrial equipment. Check the following points at the inspection.
2. Visual inspection to check pressure relief vent open or leakage of electrolyte.
3. Electrical characteristics: leakage current, capacitance, dissipation factor and the other points which are mentioned in the catalog or specification sheets.

EMERGENCY ACTION

1. If the pressure relief vent is open and some gas blows out from the capacitor, turn the main switch of the equipment off or pull out the plug from the power outlet immediately.
2. During pressure relief vent operation, extremely hot gas (over 100°C) may blow out from the vent area of the capacitors. So keep your face and skin away from capacitors during its operation. In case of eye contact, flush the open eye(s) with large amount of clean water immediately. In case of ingestion, gargle with water immediately, and do not swallow. Also do not touch electrolyte but wash skin with soap and water in case of skin contact.

STORAGE CONDITIO

1. Aluminum Electrolytic Capacitors should not be stored in high temperature or in high humidity. The suitable storage condition is 5°C-35°C, and less than 75% in relative humidity;
2. Aluminum Electrolytic Capacitors should not be stored in damp conditions such as water, salt water spray or oil spray.

3. Do not store Aluminum Electrolytic Capacitors in an environment full of hazardous gas (hydrogen sulfide gas, sulfurous acid gas, nitrous acid, chlorine gas, ammonia or bromine gas).
4. Aluminum Electrolytic Capacitors should not be stored under exposure to ozone, ultraviolet rays or radiation.
5. After one year, a capacitor should be reconditioned by applying rated voltage in series with a 1000Ω current limiting resistor for a time period of 30 minutes.

DISPOSAL

Please take either of the following actions in case of disposal. Incineration (high temperature of more than 800°C) after crushing the capacitor's body; Consignment to specialists of industrial waste.

IMPORTANT NOTES AND DISCLAIMER

1. **ROHS COMPLIANCE:** The levels of RoHS restricted materials in this product are below the maximum concentration values (also referred to as the threshold limits) permitted for such substances, or are used in an exempted application, in accordance with EU RoHS Directive (EU) 2015/863 EC (RoHS3). RoHS Test Report for this product can be obtained at Download Center.
2. **REACH COMPLIANCE:** REACH substances of high concern (SVHCs) information is available for this product. Since the European Chemical Agency (ECHA) has published notice of their intent to frequently revise the SVHC listing for the foreseeable future, REACH Test Report for this product can be obtained at Download Center.
3. All Product parametric performance is indicated in the Electrical Characteristics for the listed herein test conditions, unless otherwise noted. Product performance may not be indicated by the Electrical Characteristics if operated under different conditions.
4. NextGen Component, Inc (*NextGen*) reserves the right to make changes to this document and its products and specifications at any time without notice. Customers should obtain and confirm the latest product information and specifications before final design, purchase or use.
5. *NextGen* makes no warranty, representation or guarantee regarding the suitability of its products for any particular purpose, not does *NextGen* assume any liability for application assistance or customer product design.
6. *NextGen* does not warrant or accept any liability with products which are purchased or used for any unintended or unauthorized application. No license is granted by implication or otherwise under any intellectual property rights of NextGen.
7. *NextGen* products are not authorized for use as critical components in life support devices or systems without express written approval by *NextGen*.
8. *NextGen* requires that customers first obtain an RMA (Returned Merchandise Authorization) number prior to returning any products. Returns must be made within 30 days of the date of invoice, be in the original packaging, unused and like-new condition. At the time of quoting or purchasing, a product may say that it is Non-Cancelable/ Non-Returnable (NCNR). These products are not returnable and not refundable.